

emergency

twenty-one



REVERSOS

Beghelli

Let's start embracing the Earth again

Since 1982, we have been focusing on the interaction between technology and safety, a concept that has evolved up to now, and which for us translates into offering people the opportunity to enjoy a healthy and peaceful working and living environment.

LIGHT, the core of our business, now integrates more than ever those elements of well-being, safety and respect for the environment, which are the values and mission of our company.

We work directly with industrial and commercial entities in 9 different countries, and we distribute products in other 100 countries, safeguarding the human rights and equal opportunities of our collaborators.

Our passion for innovation, research and services translates into a technological offer that is ever closer to people's needs, while safeguarding the planet. Products such as the Salvalavita, the LED emergency luminaires and high energy-saving lighting are just a few examples.

We strongly believe that the only possible future is through respect for the environment. This is why we have a certified environmental management system.

This is why "ArchiEco", an architectural emergency range made of technopolymers of organic origin. This is why Titanium dioxide batteries, with a service life of up to 10 years, more than double that of conventional batteries.

This is why intelligent luminaires, with energy savings of up to 30% compared to standard LED luminaires.

This is why "SanificaAria", a technology capable of fighting Covid-19 as well as other flu viruses and bacteria, integrated, through a worldwide patent, even into a range of hybrid luminaires for lighting and emergency lighting.

In the years to come we will all have to think differently and act urgently to build a more sustainable future.

We will continue to strive to come up with innovations that help protect the safety of people and the environment in which we live and future generations will live.

The Beghelli SavePlanet project



825.119.000

Luminaire selection guide ►

emergency

professional
twenty-one





Subject index

Systems and luminaires	p.002
Control units for self-contained luminaires	p.098
Centralised battery systems and control units	p.108
Emergency power supply units	p.132
Emergency luminaires	p.012
Emergency luminaires for wiring systems	p.054
Atex emergency luminaires	p.062
SanificaAria hybrid luminaires	p.068
Architectural Archieco luminaires	p.076
Safety signage	p.086
Emergency conversion kit	p.092
Inibit remote control	p.106
Exclusive proposals	p.004
Beghelli NuBe cloud	p.006
B.Connect	p.008
SanificaAria system	p.004
Archieco range	p.004
Titanium battery	p.005
DRM autoripara	p.109
Infinity mode	p.005
Modulo Orma	p.005
Control system guide	p.010
Key to symbols	p.134
Analytical index	p.135
Spare batteries	p.140
General terms and conditions of sale	p.142

Luminaire selection guide

✓ Recommended

FAMILY LUMINAIRES EMERGENCY	PAGE	VERSION											MOUNTING						
		Std	AutoTest	Centralised self-testing		CentralTest			Centralised battery			SanificaAria	Orma laser	Archieco	INDOOR	OUTDOOR	RECESSED	503	
		TR	AT	AT-OPT	AT-CBL	LG	LGFM	DALI	LG230	LG24	HT230								
LOGICA	012					✓	✓		✓	✓	✓					✓	✓	✓	
INFINITA INFINITA X5	016				✓	✓	✓	✓	✓	✓	✓	✓				✓	✓	✓	
FORMULA 65	024	✓	✓	✓		✓	✓	✓	✓	✓	✓	✓				✓	✓	✓	
PRATICA	028	✓	✓										✓			✓	✓	✓	
TICINQUE TICINQUE TUTTOLED	032	✓	✓													✓	✓		
UP LED	036	✓		✓		✓	✓	✓								✓	✓		
COMPLETA	038	✓		✓		✓	✓	✓								✓	✓	✓	
STILE IN	042	✓											✓			✓		✓	
METRICA	044					✓	✓	✓	✓	✓	✓					✓	✓	✓	
LUNGALARGA LUCE	046			✓		✓	✓	✓	✓	✓	✓					✓		✓	
MULTI LENS	050	✓		✓		✓	✓	✓	✓	✓	✓					✓		✓	
LUMAX 65	052		✓			✓	✓		✓	✓	✓					✓	✓		
TUTTI FRUTTI, FRUTTOLUCE, LINEA 500	054	✓														✓			✓
BRAIN CLASSIC	060	✓														✓			✓
ACCIAIO	062					✓	✓	✓	✓	✓	✓					✓	✓		
LUNGALARGALUCE EXTREME	064			✓		✓	✓	✓	✓	✓	✓					✓	✓		
NU.DA	076	✓			✓	✓	✓	✓								✓	✓		
DESIGN	078	✓														✓	✓		✓
DOT	080	✓		✓		✓	✓	✓	✓	✓	✓		✓	✓	✓	✓	✓	✓	
ZERO	082	✓		✓		✓	✓	✓	✓	✓	✓					✓	✓		
DESIGN FLAG	084	✓		✓		✓	✓	✓	✓	✓	✓					✓	✓		
IRONFLAG	086	✓		✓		✓	✓	✓	✓	✓	✓		✓			✓	✓		
UP LED BANDIERA IP65	090	✓														✓	✓		
EXIT	088	✓		✓		✓	✓	✓	✓	✓	✓					✓	✓		
INVERTER PLUG&LIGHT	092	✓														✓	✓		
INVERTER LED	094					✓	✓									✓	✓		

Emergency

Table of Contents







SYSTEMS

TR	AT	AT - OPT (OPTICOM)	AT - CBL (CABLECOM)
STANDARD self-contained luminaires with only local diagnostics on battery (Battery Control System)	AUTOTEST self-contained luminaires with full local diagnostics (battery, light source, circuit)	AUTOTEST self-contained luminaires with programmable flow and autonomy (min 1h - max 8hrs) and testing from the dedicated APP. Management from the APP of the system LOGBook. LG - LGFM - DALI expansion modules are available to connect luminaires to the related CENTRALTEST systems.	AUTOTEST self-contained luminaires with programmable flow and autonomy (min 1h - max 8hrs) and testing with dip switch or from the dedicated APP. By integrating the Cablecom Control Unit, without additional wiring, the CENTRALTEST centralised diagnostics control is implemented, including remotely with NuBe CLOUD.
P. 010	P. 010	P. 010	P. 010
STANDARD	AUTOTEST	CENTRALISED SELF-TESTING	

SUPERVISOR CONTROL UNITS FOR SELF-CONTAINED LUMINAIRE AND NuBe CLOUD

 P. 006	 Cablecom Connect CBL P. 098	 Logica Connect LG, LGFM P. 100	 Logica SD LGFM LGFM, SD P. 104
--	---	---	--



EMERGENCY

 Logica IP65 LG, LGFM, LG230, LG24, HT230 WARRANTY 10 YEARS P. 012	 Infinita Infinita X5 IP65 AT-CBL, LG, LGFM, DALI, LG230, LG24, HT230 WARRANTY 10 YEARS P. 016	 Formula 65 IP65 TR, AT, AT-OPT, LG, LGFM, DALI, LG230, LG24, HT230 WARRANTY 10 YEARS P. 024
 Completa IP66 - IP40 TR, AT-OPT, LG, LGFM, DALI WARRANTY 10 YEARS P. 038	 Stile In IP40 TR P. 042	 Metrica IP65 LG, LGFM, DALI, LG230, LG24, HT230 WARRANTY 10 YEARS P. 044

EMERGENCY LUMINAIRE FOR WIRING SYSTEMS

 Tutti Frutti Fruttoluce Linea 500 IP40 TR P. 054	 Placca Brain Classic Emergenza IP20 TR P. 060
--	---



SanificaARIA - HYBRID LUMINAIRE WITH INTEGRATED AIR SANITIZER

 Stile In SanificaAria IP20 TR P. 068	 Pratica SanificaAria IP20 TR, AT P. 070	 Formula 65 SanificaAria IP20 TR, AT P. 072
--	---	--

archienco - ARCHITECTURAL LUMINAIRE

 Nu.da IP42 TR, AT-CBL, LG, LGFM, DALI WARRANTY 10 YEARS P. 076	 Design IP40 TR P. 078	 Dot ORMA Laser Module IP65 TR, AT-OPT, LG, LGFM, LG24, LG230, DALI, HT230 WARRANTY 10 YEARS P. 080
---	---	---

EXIT SIGNE

 Ironflag IP40 ORMA Laser Module TR, AT-OPT, LG, LGFM, DALI, LG230, LG24, HT230 WARRANTY 10 YEARS P. 086	 Exit IP40 TR, AT-OPT, LG, LGFM, DALI, LG230, LG24, HT230 WARRANTY 10 YEARS P. 088	 UpLED Bandiera IP65 IP65 TR, AT-OPT, LG, LGFM, DALI WARRANTY 10 YEARS P. 090
---	--	---

LG (LOGICA)

AUTOTEST self-contained luminaires with centralised diagnostics and control with LG Control Unit. Even remotely with NuBe CLOUD.



P. 010

LGFM

Self-contained luminaires with centralised RADIO diagnostics and control with LGFM Control Unit. Even remotely with NuBe CLOUD.



P. 010

DALI

Self-contained luminaires with centralised DALI diagnostics and control by integrating the optional DALI module.

P. 010

LG230

Luminaires powered by centralised 216VDC batteries



P. 010

LG24

Luminaires powered by centralised 24VDC batteries



P. 010

HT230

Luminaires powered from the mains, the emergency power supply units and the LG230 system.

P. 010

CENTRALTEST

CENTRALISED BATTERY

CENTRALISED BATTERY AND NuBe CLOUD SYSTEMS

Logica 230
IP40
IP20
LG230
P. 108

Logica 24
Logica 24 Dynamic
Dynamic luminaires
IP40
IP54
LG24
P. 120

POWER SUPPLY UNITS

Emergency power supply units
IP21
HT230
P. 132

**Pratica IP65
Pratica IP42**
NEW
IP65 - IP42
TR, AT
P. 028

**Ticinque
Ticinque TuttoLED**
IP65 - IP42
TR, AT
P. 032

UpLED
IP65
TR, AT-OPT,
LG, LGFM, DALI
WARRANTY 10 YEARS
P. 036

Lungalargaluce
ceiling/recessed
IP42
AT-OPT, LG230, LG24,
HT230, LG, LGFM, DALI
WARRANTY 10 YEARS
P. 046

Multi Lens
IP42
TR, AT-OPT
LG, LGFM, DALI
WARRANTY 10 YEARS
P. 050

Lumax 65
IP65
AT, LG, LGFM, LG230
LG24, HT230
WARRANTY 10 YEARS
P. 052

Ex - ATEX EMERGENCY

Acciaio emergenza
IP66
Ex
LG, LGFM, LG230, HT230
P. 062

**Lungalargaluce
Extreme**
IP65
Ex
AT, AT-OPT, LG, LGFM, DALI,
LG230, LG24, HT230
WARRANTY 10 YEARS
P. 064

Infinita SanificaAria
NEW
IP20
SANE
AT-CBL, LG, LGFM, DALI
P. 074

Zero
NEW
IP40
TR, AT-OPT, LG, LGFM, LG24,
LG230, DALI, HT230
WARRANTY 10 YEARS
P. 082

Design Flag
ORMA Laser Module
NEW
IP40
TR, AT-OPT, LG, LGFM, DALI
LG230, LG24, HT230
WARRANTY 10 YEARS
P. 084

EMERGENCY CONVERSION KIT

**LED Inverter
Plug&Light**
IP65 - IP40
TR
P. 092

LED Inverter
IP65 - IP20
LG, LGFM
WARRANTY 10 YEARS
P. 094

Exclusive Beghelli proposals

emergency



BEGHELLI NUBE CLOUD, THE RIGHT PLACE FOR YOUR SYSTEMS

NuBe is the **Cloud** platform to **access and manage all Beghelli systems**. Available to all Beghelli system installers and users, it allows you to manage and control **both lighting and emergency lighting**, both for self-contained luminaires and for centralised battery luminaires. Among the varied offered services, **predictive maintenance** can be activated, which can anticipate maintenance works on the system to prevent malfunctions.



B.CONNECT THE GATEWAY TO CENTRALISED SYSTEMS

Single App to manage all control systems of Beghelli self-contained luminaires.

It allows direct access to the luminaire, to the control unit or to the Beghelli NuBe Cloud platform. The connection to Beghelli control units is secured, password-protected. The control unit can be easily programmed by reading the unique QR code that can be found on all compatible control units, which recognises the control system (CBL, LG, LGFM) to immediately manage each individual device.

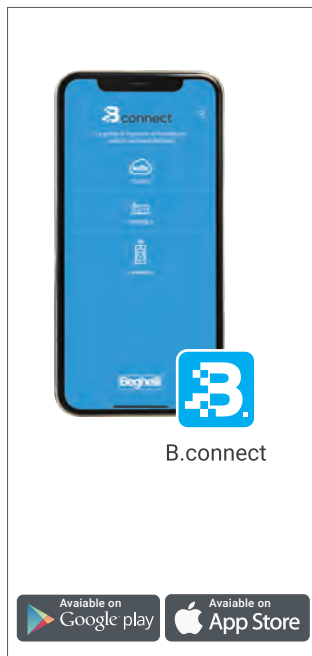

INTEGRATED AIR SANITIZER IN EMERGENCY LUMINAIRES

Hybrid emergency luminaires with integrated air sanitizer. Thanks to the exclusive **uvOxy® technology** with a closed-chamber UV-C ray flow cell and no ozone emissions, the system eliminates any risk during operation and allows a **continuous sanitisation of rooms in the presence of people**.

Numerous tests, carried out in accredited laboratories, are available online and they certify a **sanitising efficacy of over 99% against Coronavirus and bacteria** far more aggressive than COVID-19.



PAINTABLE ENVIRONMENTALLY - FRIENDLY DESIGN EMERGENCY LUMINAIRE

The new emergency range for the world of lighting designers.

An innovative concept that makes it possible to **make installed luminaires "disappear" thanks to a surface treatment that allows them to be painted**, even with normal wall paints. In addition, the ArchiEco range maintains a **reduced environmental impact** thanks to the use of completely renewable materials, recycled or biodegradable and compostable raw materials such as PHA, a polymer of organic origin.





BATTERY WITH TOP PERFORMANCE GUARANTEED FOR 10 YEARS

Beghelli uses **Titanium Dioxide (LTO) batteries**, with a maximum efficiency even in extreme environmental and operating conditions. The use of Titanium Dioxide technology in emergency luminaires ensures a unique performance in terms of durability and reliability, first and foremost the **high recharging speed that allows achieving 80% of the autonomy after just 2hrs of recharging**. Emergency luminaires incorporating this technology are covered by a **10-year guarantee**.



DOUBLE SAFETY FOR 230V CENTRALISED POWER SUPPLY

DRM Autoripara can be integrated into centrally-powered emergency luminaires (LG230). **In the event of a disaster interrupting the centralised power supply lines, the DRM module takes over from the built-in Titanium battery of the device**. In addition, the **10-year lifespan** of the integrated Titanium battery aligns the luminaires with the testing times of the centralised batteries, thus synchronising maintenance throughout the system.



INFINITE AUTONOMY, SO AS NOT TO NEVER REMAIN IN THE DARK

The Infinity Mode can be enabled in all **Cablecom (CBL)** luminaires, either in AutoTest or CentralTest version. Thanks to the CableCom communication BUS, which allows the same cables to be used both for power supply and for data transmission, in the event of a blackout, **when the rated autonomy is over, the CBL Bus will supply the electricity needed to keep the luminaire switched on over an infinite autonomy** (at a reduced flux, power supplied from the CableCom CBL BUS line).



MODULO ORMA, THE SIGNAGE OF THE FUTURE

Virtual light pictogram to indicate the nearest escape route on the ground. The system consists of a **laser micro-projector** that emits a bright and prominent arrow-shaped asymmetrical conical beam. The Modulo Orma can be integrated into some of the latest generation of emergency or signage products, providing great flexibility. In fact, to position the light signal on the ground in the correct direction, simply rotate the body of the device.



- DEVICE WARRANTY
- FAST CHARGING
- LONG LIFESPAN, UP TO 7,000 CHARGING CYCLES
- MAXIMUM CELL SAFETY IN THE EVENT OF A SHORT CIRCUIT

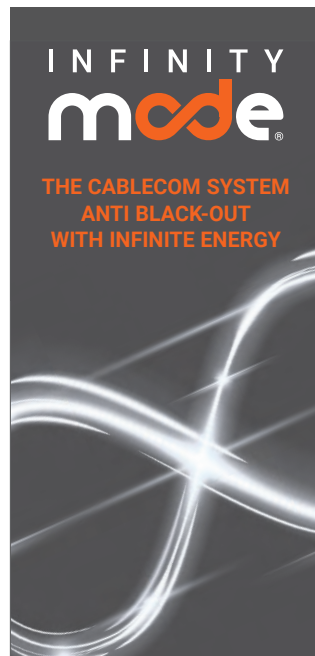

INFINITY
mode
THE CABLECOM SYSTEM
ANTI BLACK-OUT
WITH INFINITE ENERGY

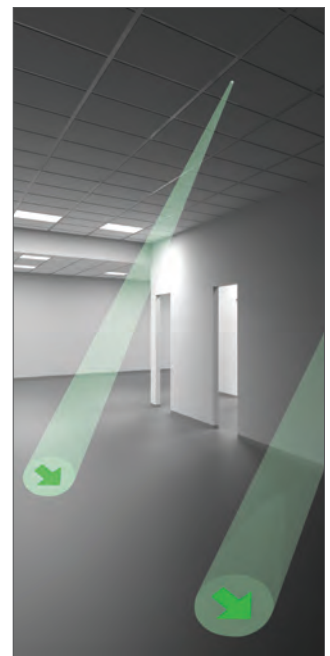

005 emergency

NuBe - the Cloud to manage, control

emergency



BEGHELLI NUBE CLOUD, THE RIGHT PLACE FOR YOUR SYSTEMS

NuBe is the **Cloud platform to access and manage all Beghelli systems**. Available to all Beghelli system installers and users, it allows you to manage and control **both lighting and emergency lighting**, both for self-contained luminaires and for centralised battery luminaires. Available free of charge in the Basic version or in the Professional version, which further extends the platform's many possibilities, such as **predictive maintenance**. This can anticipate the user's maintenance operations to prevent malfunctions.

YOUR SYSTEM DATA ARE SAFE AND ALWAYS AVAILABLE



Beghelli devices securely connect to the NuBe platform via end-to-end encryption, which guarantees high security standards.

After login using credentials, an installer will be able to navigate on the platform, with the most up-to-date security, confidentiality and data integrity protocols. Availability of information on the installed systems is guaranteed, and access is possible from any device, from a mobile workstation or from one's own office, with real-time evidence of occurring malfunctions or that still need to be managed. Customers will also be able to access their system, with a less technical and more simplified display of information, adapted to their needs.

Even in the event of a black-out, battery-powered Beghelli control units continue to manage the system, carrying out their work locally. Operation is guaranteed even in the absence of connectivity, the control units autonomously collect data from the system, and they publish local data on the NuBe as soon as the internet connection is restored.

and archive your systems

NUBE PRO ADVANCED FEATURES

The NuBe PRO version further extends the features of the portal. There is no longer any limit to the number of control units that can be connected, and therefore the number of luminaires, which can also be from different control systems, both for emergency lighting and lighting (CBL+LG+LGFM+SD). Upgrading to the NuBe PRO version offers access to advanced services such as the insertion of emergency luminaires on photos or room plans, unlimited LogBook history and predictive maintenance capable of anticipating malfunctions, foreseeing the maintenance interventions needed for a correct operation of the system.

NuBe	MAX. NUMBER OF LUMINAIRES PER SYSTEM	* MULTI-SYSTEM MANAGEMENT	SYSTEM AND MAX. NO. OF CONTROL UNITS PER SYSTEM	SYSTEM LOGBOOK HISTORY	PREDICTIVE MAINTENANCE	ROOM PHOTO MANAGEMENT	PLANIMETRY MANAGEMENT	SPARE PART MANAGEMENT	NOTIFICATION MANAGEMENT
NuBe	256		8 x CBL Cablecom alternatively 2 x LG Compact alternatively 1 x LGFM Compact	12 MONTHS					BASIC
NuBe PRO	NO LIMITS	✓	No limit on the no. of CBL Cablecom LG Compact LGFM Compact LGFM SD Logica	NO LIMITS	✓	✓	✓	✓	ADVANCED

* Option valid both for CB - LG - LGFM emergency control systems and for SD lighting systems



OVERVIEW

System status with a dynamic live graph, signalling of any faults and access to the latest reports.

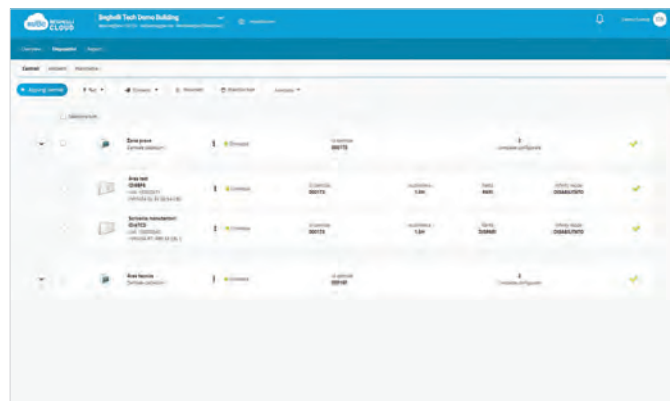

DEVICES

Tree view of devices (control units and emergency luminaires) with a description of their current status.

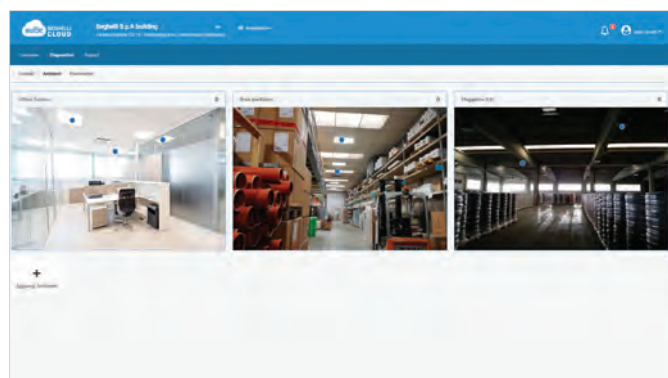

ENVIRONMENTS

Positioning of luminaires on existing room photos (by drag and drop onto the photo in the desired position).



PLANIMETRY

Positioning of devices on floor plans (by drag and drop onto the photo in the desired position).

A single APP to manage all your systems

emergency

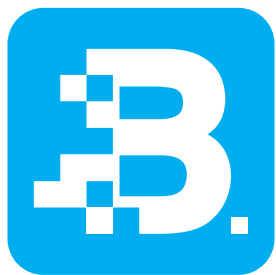

B.connect

Single App to manage all control systems of Beghelli self-contained luminaires. **It allows direct access to the luminaire, to the control unit or to the Beghelli NuBe Cloud platform.** The connection with Beghelli control units is secured, password-protected, and it can be made by reading the QR code found on all compatible control units.

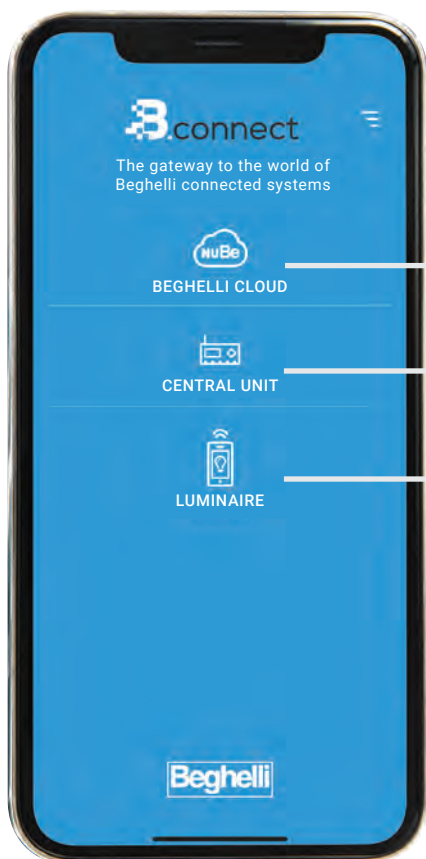

ACCESS TO THE SYSTEM THROUGH THE BEGHELLI CLOUD

The APP allows direct access to the NuBe platform. All programming, remote control and system logbook view functions become available immediately.

NuBe stores all configurations of all systems and makes them always available on your smartphone.



ACCESS TO THE SYSTEM THROUGH DIRECT COMMUNICATION WITH THE CONTROL UNIT

B.connect is designed for a direct reading of the QR code of the control unit, which will detect the identification of the device and will also recognise the type of control system (CBL, LG, LGFM). After logging in, the main control and management functions of the entire system will already be available. The system uses local WiFi technology that does not require an internet connection.

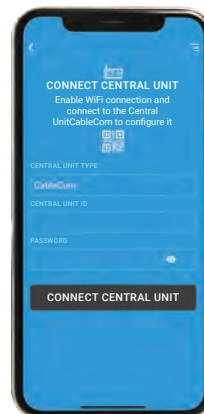

DIRECT ACCESS TO THE EQUIPMENT THROUGH OPTICAL COMMUNICATION

In this mode, it is possible to directly communicate with the luminaires via the smartphone flash. A patented communication technology that allows light impulses to be transmitted to luminaires that have an intelligent light sensor. The commands that can be set are for programming lamp parameters and conducting functional tests as well as the management of the sanitisation system integrated in the hybrid luminaires of the SanificaAria series.

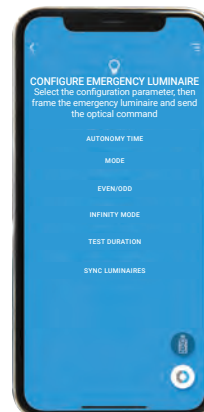

Systems, both remotely and locally

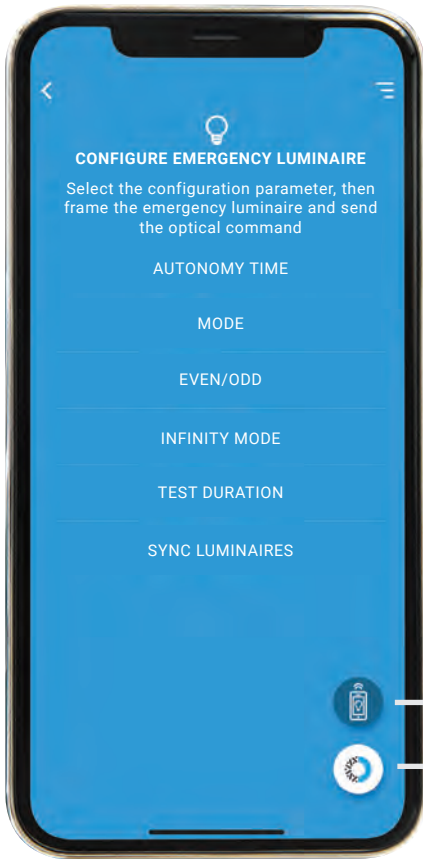

LAMP TEST

B.connect can enable all functional and autonomy tests required by current emergency lighting regulations. The commands are transmitted directly from the smartphone to each individual luminaire equipped with an intelligent light sensor.

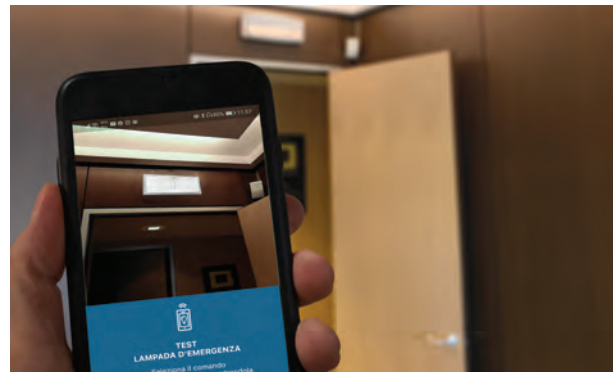
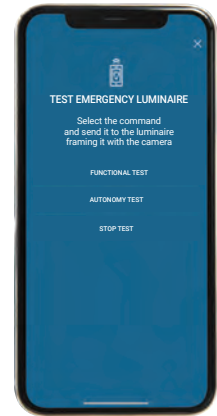

Optical communications between the smartphone flash and the intelligent light sensor integrated in compatible emergency luminaires



AIR SANITISATION

The speed-adjustable luminaires of the SanificaAria series are provided with an intelligent light sensor that can receive light commands transmitted from the B.Connect App via the smartphone flash. This mode allows you to enable or disable the sanitising process, to set the speed of the fans that introduce air into the uvOxy® sanitising cell and to manage the sanitising times according to the environment and the requirements.



Guide to control systems

emergency

FROM LOCAL DIAGNOSTICS TO SELF-DIAGNOSIS WITH CENTRALISED CONTROL

Beghelli emergency luminaires always comply with EN 50171, EN 50172, EN 62040-1-1, EN 62040-2, and are available in different control modes. **TR** means luminaires in standard version with local battery control, **AT** are luminaires with local diagnostics of all luminaire functions; in the **AT-OPT** (AutoTest Opticom) and **AT-CBL** (AutoTest Cablecom) versions, modules (to be ordered separately) can be integrated into the luminaire for connection to **LG** (Logica), **LGFM** (Logica radio FM) and **DALI** centralised systems. Luminaires are also available in Centratest mode, to be used in conjunction with the **CBL** (Cablecom), **LG**, **LGFM**, **LG24** (Logica 24V) and **LG230** (Logica 230V) control units.

SYSTEM	SELF-DIAGNOSTICS	CENTRALISED POWER SUPPLY	CENTRALISED CONTROL	MAX. NUMBER OF LUMINAIRES	BUS	RADIO	POWER SUPPLY VOLTAGE	APP LOCAL	CLOUD		POSSIBILITIES FOR EXPANSION	CONTROL UNIT Order Code
									NUBE	NUBE PRO		
TR							230VAC					-
AT	✓						230VAC					-
AT-OPT	✓						230VAC	✓			LG, LGFM, DALI	-
AT-CBL	✓		✓	32/Infinite*			230VAC	✓	✓		LG, LGFM, DALI	20151
LG	✓		✓	Up to 128/3968**	✓		230VAC	✓	✓			12100C
LGFM	✓		✓	256 (12128C) 996 (21102)		✓	230VAC	✓	✓			12128C 21102
DALI	✓		✓	Up to 64	✓		230VAC	✓	✓			12100C
LG230	✓	✓	✓	3072			230VAC/216VDC		✓			See p. 108
LG24	✓	✓	✓	256			24VDC		✓			See p. 120
HT230		✓					230VAC/216VDC					-

* Each system connected to the NuBe Cloud can manage an infinite number of control units and, therefore, of luminaires. In particular, with the CBL control units, large-scale systems can be implemented with ease
 ** By integrating the Supervisor Control Unit Order Code 12131C, up to 3968 devices can be connected (128 luminaires x 31 LG Logica control units)

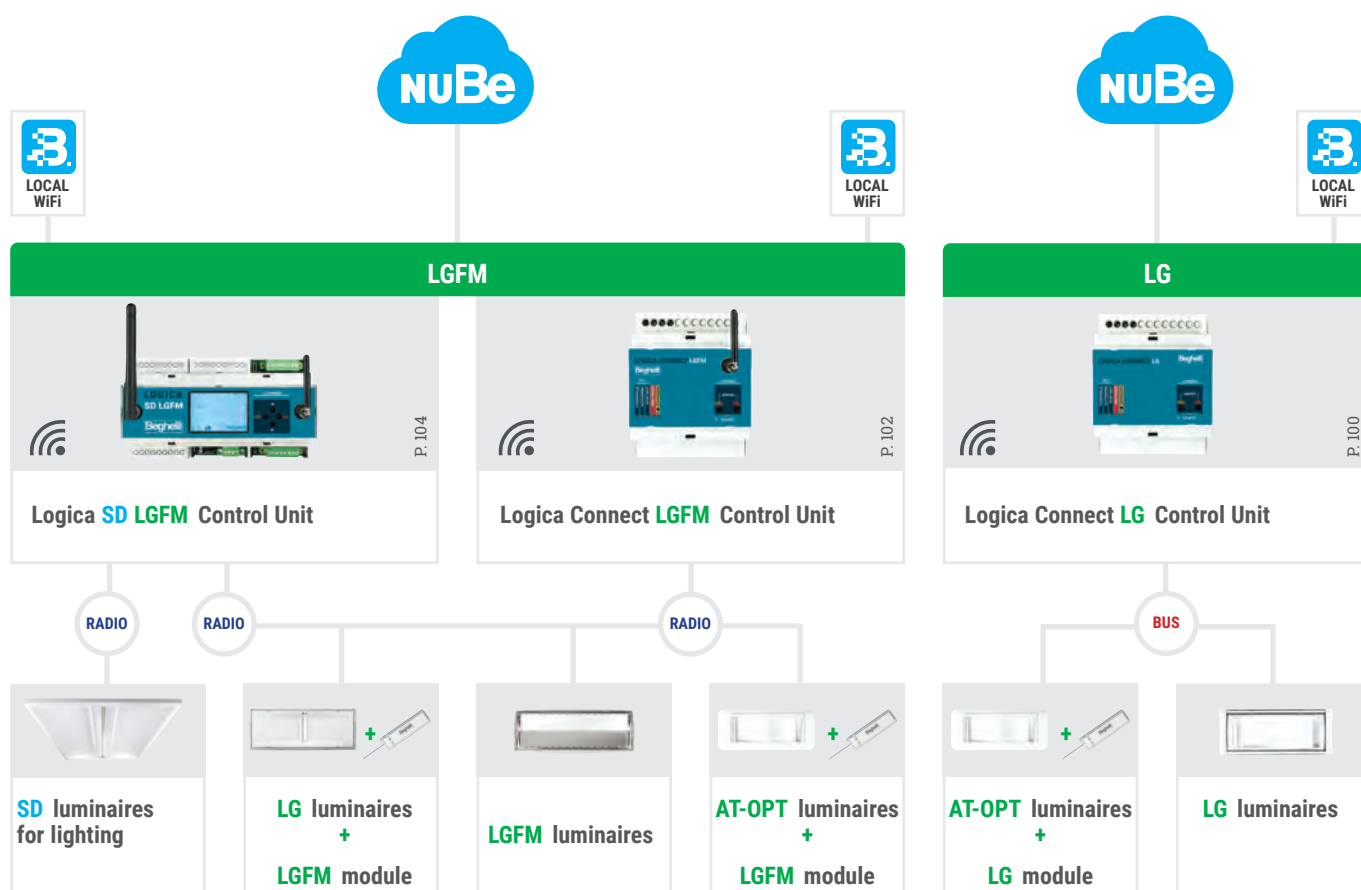

CENTRALTEST, SELF-CONTAINED LUMINAIRES

CBL (Cablecom) is the easiest way to centralise the control and diagnosis of emergency systems, thanks to its innovative data transmission system that directly uses the emergency power lines without adding a dedicated BUS line. **LG** (Logica) is an advanced management system for the entire emergency system, requiring a dedicated BUS line, but offering best-in-class possibilities. If maximum performance is required, but it is not possible to insert a dedicated BUS line, **LGFM** (Logica Radio FM) allows the management of the entire emergency system via radio, without additional wiring.

CENTRALTEST, CENTRALISED BATTERY LUMINAIRES

When the need arises for a centralised battery control system, **LG230** (Logica 230V) makes it possible to create even large systems that are perfectly manageable thanks to the wide range of accessory emergency power supply units that allow expansion and splitting. For smaller systems, **LG24** (Logica 24V) is ideal. It uses 24VDC to power the devices, guaranteeing extreme safety in all fields of application, thanks to the low operating voltage of the dedicated power lines. The systems are complementary and can be integrated into the same overall system.

SINGLE INTERFACE FOR CENTRALISED SYSTEMS

All Beghelli systems use the **B.connect APP** for the local programming of main parameters.

From the same APP, you can connect to the **NuBe Cloud Portal**, where luminaire management and system programming is more advanced and can also be done remotely.

NuBe is not only a WEB portal for the control and management of Beghelli systems, but it also allows cloud storage of system data.

The centralised battery systems, equipped with a touch screen and WEB connection, can be connected to NuBe even without the **B.connect APP**.

NUBe PRO ALLOWS THE AGGREGATION OF SEVERAL CONTROL UNITS, EVEN FROM DIFFERENT SYSTEMS. IT OPERATES AS A SINGLE SUPERVISOR CONTROL UNIT THAT CAN MANAGE AN INFINITE NUMBER OF CONTROL UNITS AND THEREFORE LUMINAIRES, INCLUDING LIGHTING.

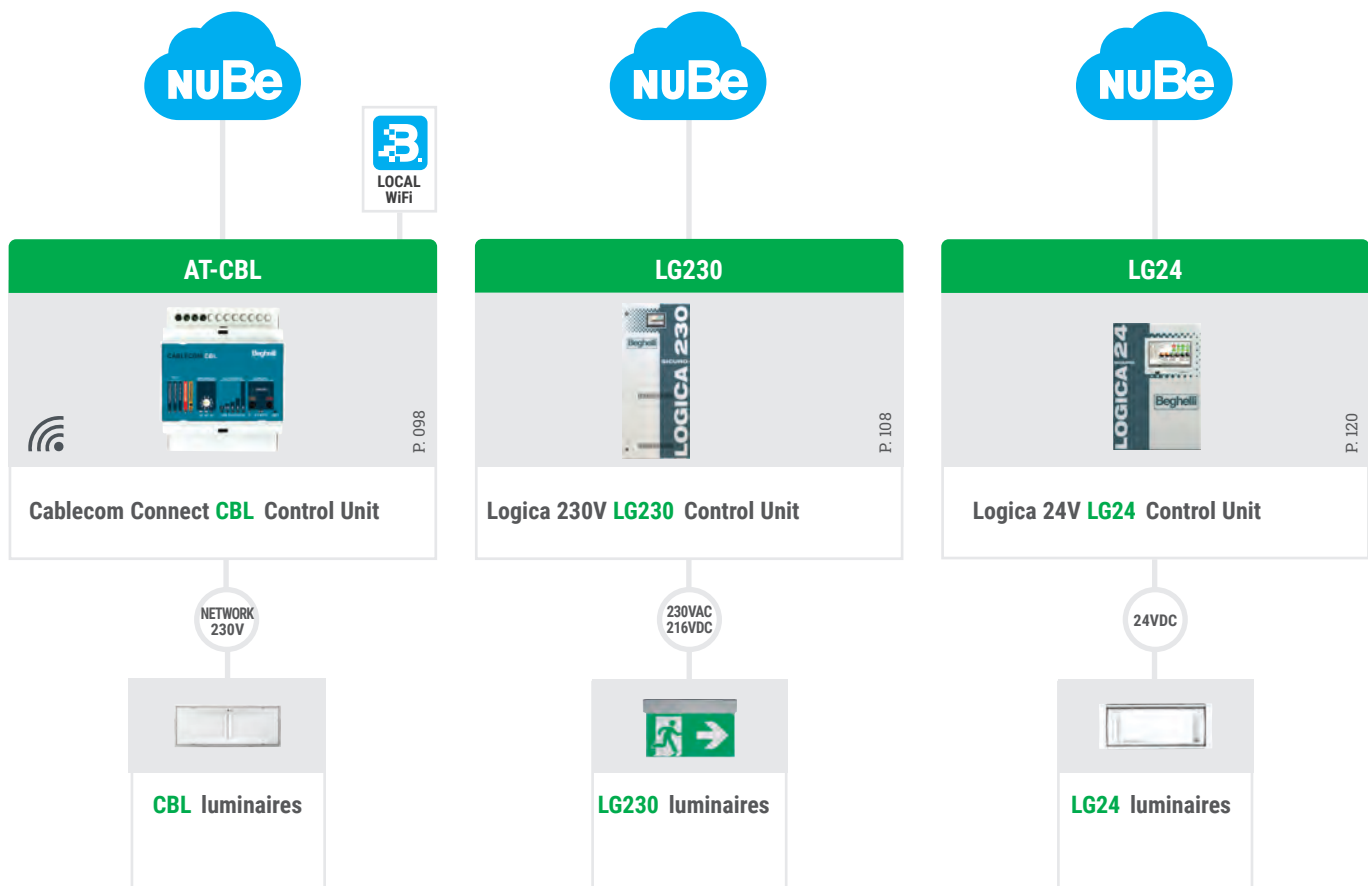



IP65

IK07

850°



Batt. LTO

+45°C
-20°C

Batt. NiMH

+40°C
0°C

Batt. Pb

+40°C
0°C



Luminous flux up to **2,000 lm**, and adjustable autonomy.

Fast-charging **Titanium battery**, with 10 years of service life and for extreme working temperatures.



Great flexibility thanks to multiple versions and accessories for all installation requirements. Pictograms supplied.



Quick-fit bracket with level bubble to speed up correct positioning, mounting and maintenance time.

Applications

Industry, Services, Hospitals, Schools, Hotels, Restaurants

Characteristics

Power supply* 230VAC ± 10%, 50÷60Hz

Mounting Wall, ceiling, recessed, false ceiling

Recharging time 12h with LTO battery

Housing Polycarbonate, white RAL 9003

Optics Symmetrical, anti-glare metallic polycarbonate

Screen Clear polycarbonate

Compliance EN 60598-1, EN 60598-2-2, EN 60598-2-22, UNI EN 1838, UNI 11222, EN 62034

* LG230, LG24, HT systems consider the parameters of the control unit used

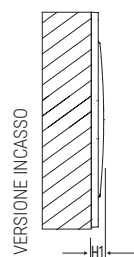

Version	Dimensions mm				Distance of visibility (DV)
	L	B	H	H1	
Standard	406	147	63	-	20m
Recessed	440	170	-	10	20m

Performance according to EN 1838

Height (m)	Centre distance (m) ESCAPE ROUTES		Illuminated surface area (m) LARGE AREAS	
	Wall	Ceiling	Wall	Ceiling
2.5	11	-	6x9	-
3	-	19	-	10x16
7	-	28	-	12x26

Lighting >1lx at floor level along the centre line without reflections Emax/Emin <40

Lighting >0.5lx at floor level without reflections Emax/Emin <40

Performance with reference to luminaire Order Code 19410 1100 lm Maintenance coefficient 0.8



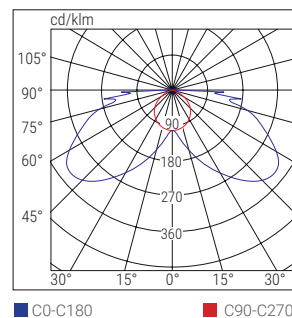



LOGICA











	Order Code	W eq.	Description	Version	Autonomy h	Battery	FLUX SE lm	Batt. AUTORIPARA SUPPLIED Flux SE lm	FLUX SA lm		Input power		Weight Kg	Packaging Single/ Multi pack	Conform.
									DC	AC	DC	AC			
LG	12182	8	LOG LED LG 8W SE 2/4/6H	SE	2/4/6	Pb 6V 4Ah	750/450/350		-		4W	2.2	1/6		
	12185	8	LOG LED LG 8W SA/PS 2/4/6H	SA/SE/PS	2/4/6	NiMh 7.2V 2.5Ah	750/450/350		400		8W	2.2	1/6		
	12183	11	LOG LED LG 11W SE 1.5/3/4H	SE	1.5/3/4	Pb 6V 4Ah	900/550/450		-		4W	2.2	1/6		
	12186	11	LOG LED LG 11W SA/PS 1.5/3/4H	SA/SE/PS	1.5/3/4	NiMh 7.2V 2.5Ah	900/550/450		500		10W	2.2	1/6		
	12184	24	LOG LED LG 24W SE 1/2/3H	SE	1/2/3	Pb 6V 4Ah	1100/750/550		-		6W	2.2	1/6		
	12187	24	LOG LED LG 24W SA/PS 1/2/3H	SA/SE/PS	1/2/3	NiMh 7.2V 2.5Ah	1100/750/550		600		14W	2.2	1/6		
	19410	36	LOGICA LED LTO LGAR SE 1100LM	SE	1/1.5/3*	LTO 9.6V 1.2Ah	➔	2000/1500/800			7W	2.2	1/6		
	19411	36	LOGICA LED LTO LGAR SA 1100LM	SA/SE/PS	1/1.5/3*	LTO 9.6V 1.2Ah	➔	2000/1500/800	1000		13W	2.2	1/6		
LGM	12182FM	8	LOG LED LGM 8W SE 2/4/6H	SE	2/4/6	Pb 6V 4Ah	750/450/350		-		5W	2.2	1/6		
	12185FM	8	LOG LED LGM 8W SA/PS 2/4/6H	SA/SE/PS	2/4/6	NiMh 7.2V 2.5Ah	750/450/350		400		9W	2.2	1/6		
	12183FM	11	LOG LED LGM 11W SE 1.5/3/4H	SE	1.5/3/4	Pb 6V 4Ah	900/550/450		-		5W	2.2	1/6		
	12186FM	11	LOG LED LGM 11W SA/PS 1.5/3/4H	SA/SE/PS	1.5/3/4	NiMh 7.2V 2.5Ah	900/550/450		500		11W	2.2	1/6		
	12184FM	24	LOG LED LGM 24W SE 1/2/3H	SE	1/2/3	Pb 6V 4Ah	1100/750/550		-		7W	2.2	1/6		
	12187FM	24	LOG LED LGM 24W SA/PS 1/2/3H	SA/SE/PS	1/2/3	NiMh 7.2V 2.5Ah	1100/750/550		600		15W	2.2	1/6		
LG230	31140	8	LOGICA LED 8W LG230						400	4.1W	8.5VA	1.4	1/6		
	31141	11	LOGICA LED 11W LG230 LS-UV						500	6.4W	8.1VA	1.8	1/6		
	31099	24	LOGICA LED 24W LG230 LS-UV						900	10.4W	12VA	1.8	1/6		
	31120	36	LOGICA LED 36W LG230 LS-UV						1400	15W	15.9VA	1.8	1/6		
LG24	32096	8	LOGICA LED 8W LGS24				400		400	3.8W	-	1.8	1/6		
	32089	36	LOGICA LED 36W LGS24 LS-UV				400		1400	4.3W	15.4VA	1.8	1/6		
HT230	17403	8	LOGICA LED 8W HT						400	4.4W	8.9VA	1.4	1/6		
	17404	11	LOGICA LED 11W HT						550	6.1W	6.4VA	1.8	1/6		
	17405	24	LOGICA LED 24W HT						900	10.2W	10.4VA	1.8	1/6		
	17406	36	LOGICA LED 36W HT						1400	14.3W	14.5VA	1.8	1/6		

* The indicated flux and autonomy refer to the luminaire set in HIGH FLUX mode - with the LONG OPERATING TIME setting, the autonomy doubles and the flux is reduced.

ACCESSORIES - included

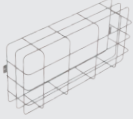
	<p>AR LTO 9.6V 1.2Ah BATTERY SYSTEM Compatible with Order Code 19410 - 19411</p> <p>Order Code RA04 - LTO 9.6V 1.2Ah</p>		<p>RH SCREEN - SA version only Screen printing on opal polycarbonate</p> <p>Order Code 12175</p>
	<p>CABLE CONDUIT GLAND</p>		<p>LH SCREEN - SA version only Screen printing on opal polycarbonate</p> <p>Order Code 12176</p>
	<p>QUICK WALL MOUNTING BRACKET IP65</p> <p>Order Code 12199</p>		<p>DOWN SCREEN - SA version only Screen printing on opal polycarbonate</p> <p>Order Code 12177</p>

ACCESSORIES - to be ordered separately

	<p>RECESSED FRAME BOX</p> <p>Order Code 12179</p>		<p>UP SCREEN Screen printing on opal polycarbonate</p> <p>Order Code 12178</p>
	<p>FALSE CEILING BRACKET Recess hole 414X150 mm</p> <p>Order Code 12180</p>		<p>RH SCREEN Screen printing on opal polycarbonate</p> <p>Order Code 12175</p>
	<p>PROTECTIVE GRILLE Dimensions 440x215x99 mm</p> <p>Order Code 3912</p>		<p>LH SCREEN Screen printing on opal polycarbonate</p> <p>Order Code 12176</p>
	<p>LG INIBIT REMOTE CONTROL RM for LG versions only</p> <p>Order Code 12101</p>		<p>DOWN SCREEN Screen printing on opal polycarbonate</p> <p>Order Code 12177</p>

LG



Infinita

emergency



Batt. LTO



Luminous flux up to **1700lm** and **infinite autonomy** (reduced flux) with the **Infinity mode**.

Fast-charging **Titanium battery**, with 10 years of service life and for extreme working temperatures.



Optimum performance for both wall and ceiling mounting with installation distances of up to 34m.



Numerous pre-drilled inlets and connection accessories.

Applications

Industry, services

Characteristics

Power supply* 230VAC ± 10%, 50-60Hz

Mounting Wall, ceiling, recessed, false ceiling, wall/ceiling edge mounting, suspended, suspended on rods

Recharging time 12h

Housing Polycarbonate, white RAL 9003

Optics PMMA, Total Internal Reflection

Screen Clear polycarbonate

Compliance EN 60598-1, EN 60598-2-2, EN 60598-2-22, UNI EN 1838, UNI 11222, EN 62034

* LG230, LG24, HT systems consider the parameters of the control unit used

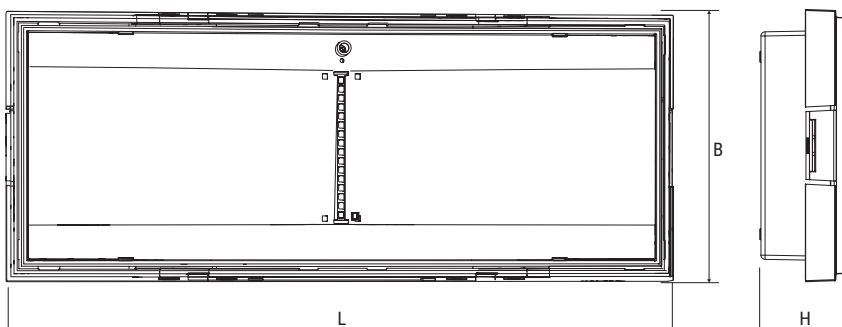

Dimensions mm			Distance of visibility (DV)
L	B	H	
325	130	45	25m

Performance according to EN 1838

Height (m)	Centre distance (m) ESCAPE ROUTES		Illuminated surface area (m) LARGE AREAS	
	Wall	Ceiling	Wall	Ceiling
2.5	14	-	8x9	-
3	-	20	-	10x16
7	-	20	-	15x15

Lighting >1lx at floor level along the centre line without reflections Emax/Emin <40

Lighting >0.5lx at floor level without reflections Emax/Emin <40

Performance with reference to luminaire Order Code 19460 1000 lm

Maintenance coefficient 0.8

INFINITA

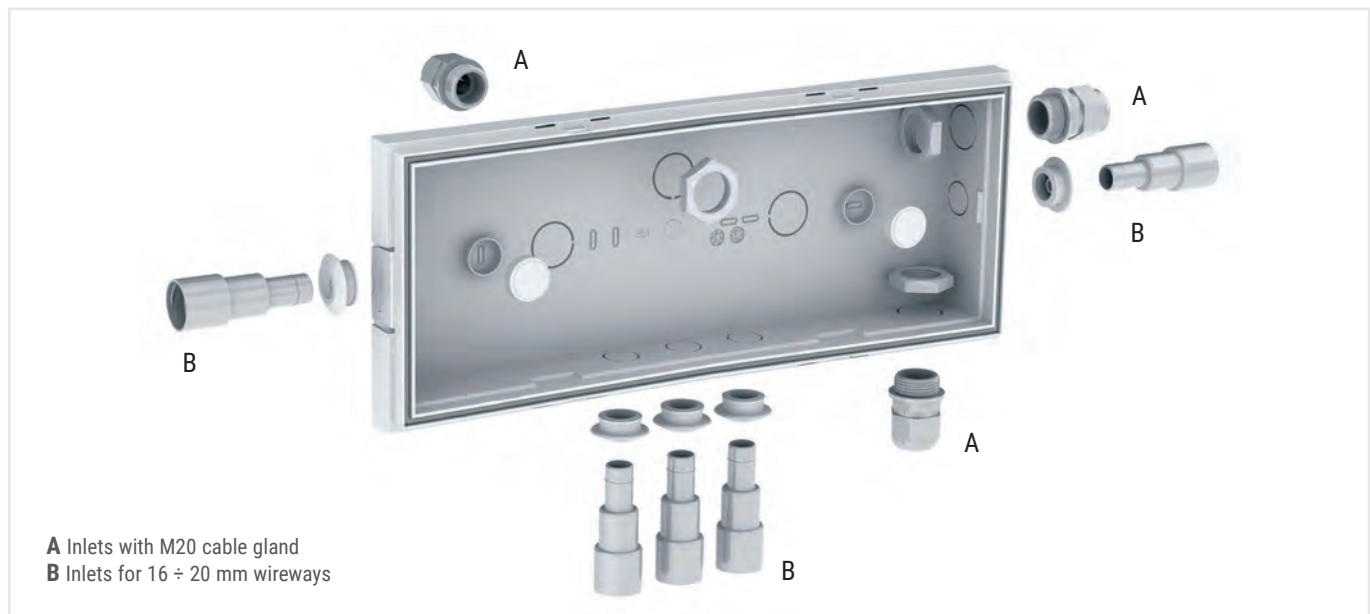
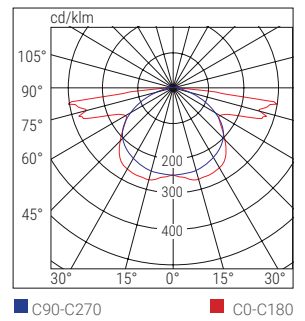



	Order Code	W eq.	Description	Version	Autonomy h	Battery	FLUX SE lm	Batt. AUTORIPARA SUPPLIED Flux SE lm	FLUX SA lm	Input power DC	AC	Weight Kg	Packaging Single/ Multi pack	Conform.
AT-CBL	19450	11	INFINITA RTI IP65 SE CBL LTO L	SE	1/1.5/ 2/3/8	4.8V 0.5Ah LTO	250/170/130/90/40	-		1W		0.6	1/6	
	19451	24	INFINITA RTI IP65 SE CBL LTO XL	SE	1/1.5/2/3/8	4.8V 1.2Ah LTO	500/340/260/180/70	-		2.6W		0.6	1/6	
	19452	11	INFINITA RTI IP65 SA CBL LTO L	SA/SE	1/1.5/2/3/8	4.8V 0.5Ah LTO	250/170/130/90/40	-	90	1.8W		0.6	1/6	
	19453	24	INFINITA RTI IP65 SA CBL LTO XL	SA/SE	1/1.5/2/3/8	4.8V 1.2Ah LTO	500/340/260/180/70	-	250	4.8W		0.6	1/6	
	19454	24*	INFINITA RTI SE CBL LTO XL 700lm	SE	1/1.5/2/3/8	4.8V 1.2Ah LTO	700/500/400/250/100	-		2.6W		0.6	1/6	
	19455	24*	INFINITA RTI SA CBL LTO XL 700lm	SA/SE	1/1.5/2/3/8	4.8V 1.2Ah LTO	700/500/400/250/100	-	250	4.8W		0.6	1/6	
	19460	36	INFINITA GL RTI SA/SE CBL LTO	SA/SE	1/1.5/2/3/8	2x4.8V 1.2Ah LTO	1000/680/525/370/145	-	250	4.8W		0.6	1/6	
LG	19470	36	INFINITA ULTIMATE RTI SA/SE LTO	SA/SE/PS	1/1.5/3*	9.6V 1.2Ah LTO		1700/1150/620	850	13W		0.6	1/6	
			LGFM	Standalone luminaires with Centralised Radio Diagnostics integrating the Module Order Code 15037										
			DALI	Standalone luminaires with Dali Centralised Diagnostics integrating the Module Order Code 15038										
LG230	31170	11	INFINITA RTI LGS230 SA/SE L						500	4.5W	8.6VA	0.6	1/6	
	31171	24	INFINITA RTI LGS230 SA/SE XL						1500	15.1W	16.3VA	0.6	1/6	
LG24	32110	11	INFINITA RTI LGS24 SE L						500	3.9W	-	0.6	1/6	
	32111	24	INFINITA RTI LGS24 SA/SE XL						1500	4.3W	16.1VA	0.6	1/6	
HT230	31174	11	INFINITA RTI HT L						500	4.5W	9VA	0.6	1	
	31175	24	INFINITA RTI HT XL						1500	15.1W	16.1VA	0.6	1	

* The indicated flux and autonomy refer to the luminaire set in HIGH FLUX mode - with the LONG OPERATING TIME setting, the autonomy doubles and the flux is reduced.









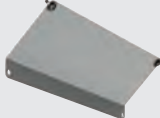

Infinita

emergency

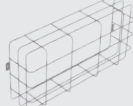
ACCESSORIES - included

	<p>AR LTO 9.6V 1.2Ah BATTERY SYSTEM Compatible with Order Code 19470</p> <p>Order Code RA04</p>		<p>CONDUIT ADAPTER 16/20 mm WHITE Mounting with a Ø16 or Ø20 mm conduit</p>
	<p>CABLE GLAND M20 WITH VENT</p>		<p>5-POLE FEED-THROUGH WIRING HT230 versions only</p> <p>Order Code 20155</p>
	<p>CABLE GLAND MEMBRANE M16 IP65</p>		<p>LH/RH/DOWN/UP STICKERS (included for SA versions only)</p> <p>Order Code 4682</p>

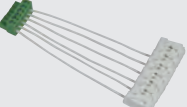
ACCESSORIES - to be ordered separately

	<p>EDGE MOUNTING SCREEN 25M</p> <p>Order Code 4681</p>		<p>45° BRACKET</p> <p>Order Code 4685</p>
	<p>RECESSED LED BOX</p> <p>Order Code 4683</p>		<p>SUSPENDED MOUNTING RODS 250 - 500 - 1000 mm Order Code 4315 (250 mm) - 4316 (500 mm) 4317 (1000 mm)</p>
	<p>PLASTERBOARD RECESSED MOUNTING BRACKET</p> <p>Order Code 4687</p>		<p>PROTECTIVE GRILLE 440x215x99 mm</p> <p>Order Code 3912</p>
	<p>EDGE MOUNTING FIXING BRACKET</p> <p>Order Code 4686</p>		<p>SUSPENDED MOUNTING HOOKS</p> <p>Order Code 3723</p>
	<p>5-POLE FEED-THROUGH WIRING For all versions except LG</p> <p>Order Code 20155</p>		<p>LGFM MODULE LG versions only</p> <p>Order Code 15037</p> <p>LGFM</p>
	<p>7-POLE FEED-THROUGH WIRING LG versions only</p> <p>Order Code 20156</p>		<p>DALI MODULE LG versions only</p> <p>Order Code 15038</p> <p>DALI</p>
	<p>LG INIBIT REMOTE CONTROL RM for LG versions only</p> <p>Order Code 12101</p> <p>LG</p>		



Infinita X5

emergency



IP65 IK08 850° Batt. LTO +45°C -20°C



- Luminous flux up to **1500lm** and infinite autonomy (reduced flux) with the **Infinity mode**. Fast-charging **Titanium battery**, with 10 years of service life and for extreme working temperatures.
- Optimum performance for ceiling mounting, either at **7m** or **12m**, with installation distances of up to 34m.
- Optical system with 5 interchangeable lenses to adapt the area of intervention to the need for both anti-panic areas and escape routes.
- Numerous pre-drilled inlets and connection accessories.

Applications

Industry, services, high-risk areas

Characteristics

Power supply* 230VAC ± 10%, 50÷60Hz

Mounting Wall, ceiling, recessed, false ceiling, suspended, suspended with rods

Recharging time 12h

Housing Polycarbonate, white RAL 9003

Optics Clear polycarbonate lenses

Screen Clear polycarbonate

Compliance EN 60598-1, EN 60598-2-2, EN 60598-2-22, UNI EN 1838, UNI 11222, EN 62034

* LG230, LG24, HT systems consider the parameters of the control unit used

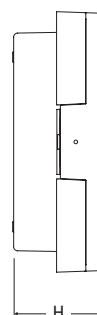
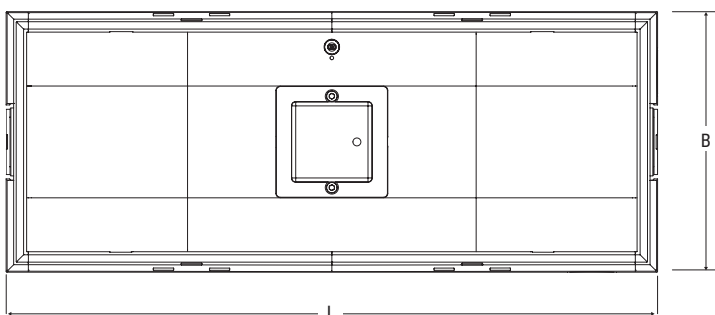

Dimensions mm		
L	B	H
325	130 152	45

020

Reference standard UNI EN 1838

Lens	Height (m) 	Centre distance (m) ESCAPE ROUTES 		Illuminated surface area (m) LARGE AREAS 	
		Wall	Ceiling	Wall	Ceiling
Lungaluce 3m	3	-	11	-	-
Lungaluce 7m	7	-	28	-	-
Largaluce 3m	3	-	-	-	7X7
Largaluce 7m	7	-	-	-	20x20
High risk	7	-	-	-	Ø3m - 30lx
				Lighting >1lx at floor level along the centre line without reflections Emax/Emin <40	
				Lighting >0.5lx at floor level without reflections Emax/Emin <40	

Performance with reference to luminaire Order Code 19461 900lm

Maintenance coefficient 0.8

HIGH RISK

87%

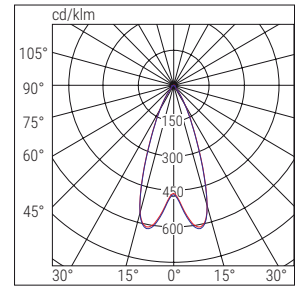

LUNGALUCE 3m 85%

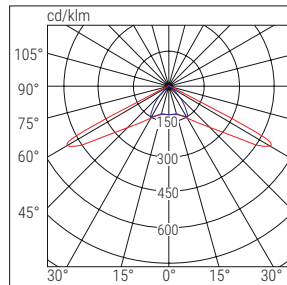

■ C0-C180 ■ C90-C270

LUNGALUCE 7m 85%

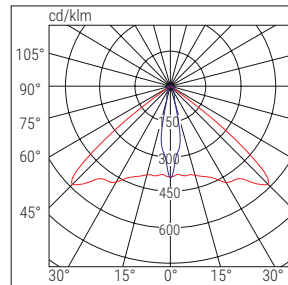

■ C0-C180 ■ C90-C270

LARGALUCE 3m 90%

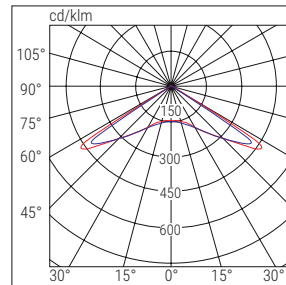

■ C0-C180 ■ C90-C270

LARGALUCE 7m 87%

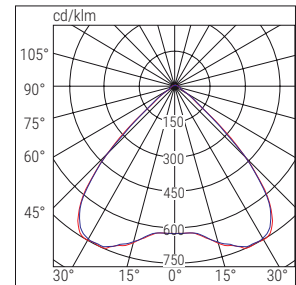

■ C0-C180 ■ C90-C270

	Order Code	W eq.	Description	Version	Autonomy h	Battery	FLUX SE lm	Batt. AUTORIPARA SUPPLIED Flux SE lm	FLUX SA lm	Input power		Weight Kg	Packaging Single/ Multi pack	Conform.
										DC	AC			
AT-CBL	19461	24GL	INFINITA GL 5X SA/SE CBL LTO	SA/SE	1/1.5/2/3/8	2x4.8V 1.2Ah LTO	900/600/470/330/130		250		4.8W	0.6	1/6	
	19471	36	INFINITA ULTIMATE 5X SA/SE LTO	SA/SE/PS	1/1.5/3*	2x9.6V 1.2Ah LTO		1500/1000/550	700		13W	0.6	1/6	
	LGFM	Standalone luminaires with Centralised Radio Diagnostics integrating the Module Order Code 15037												
DALI	Standalone luminaires with Dali Centralised Diagnostics integrating the Module Order Code 15038													
LG230	31172	24	INFINITA 5X LGS230 SA/SE XL						1100	11.4W	12.4VA	0.6	1/6	
LG24	32112	24	INFINITA 5X LGS24 SA/SE XL				500		1100	4.3W	11.4VA	0.6	1/6	
HT230	31176	24	INFINITA 5X HT XL				-		1100	10.5W	10.8VA	0.6	1/6	









* The indicated flux and autonomy refer to the luminaire set in HIGH FLUX mode - with the LONG OPERATING TIME setting, the autonomy doubles and the flux is reduced.

NEXT >







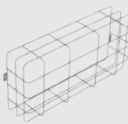

Infinita X5

emergency

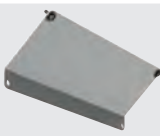
ACCESSORIES - included

	<p>AR LTO 9.6V 1.2Ah BATTERY SYSTEM Compatible with Order Code 19471</p> <p>Order Code RA04</p>		<p>HIGH RISK LENS</p>
	<p>CABLE GLAND MEMBRANE M16 IP65</p>		<p>LUNGALUCE LENS 3m</p>
	<p>CONDUIT ADAPTER 16/20 mm WHITE Mounting with a Ø16 or Ø20 mm conduit</p>		<p>LUNGALUCE LENS 7m</p>
	<p>5-POLE FEED-THROUGH WIRING HT230 versions only</p> <p>Order Code 20155</p>		<p>LARGALUCE LENS 3m Fitted as standard</p>
			<p>LARGALUCE LENS 7m</p>

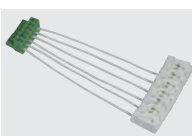
ACCESSORIES - to be ordered separately

	<p>RECESSED BOX</p> <p>Order Code 4683</p>		<p>PROTECTIVE GRILLE 440 x 215 x 99 mm</p> <p>Order Code 3912</p>
	<p>PLASTERBOARD RECESSED MOUNTING BRACKET</p> <p>Order Code 4687</p>		<p>SUSPENDED MOUNTING RODS 250 - 500 - 1000 mm Order Code 4315 (250 mm) - 4316 (500 mm) - 4317 (1000 mm)</p>
	<p>45° BRACKET</p> <p>Order Code 4685</p>		<p>SUSPENDED MOUNTING HOOKS</p> <p>Order Code 3723</p>
	<p>5-POLE FEED-THROUGH WIRING For all versions except LG</p> <p>Order Code 20155</p>		<p>LGFM MODULE LG versions only</p> <p>Order Code 15037</p> <p>LGFM</p>
	<p>7-POLE FEED-THROUGH WIRING LG versions only</p> <p>Order Code 20156</p>		<p>DALI MODULE LG versions only</p> <p>Order Code 15038</p> <p>DALI</p>
	<p>LG INIBIT REMOTE CONTROL RM for LG versions only</p> <p>Order Code 12101</p> <p>LG</p>		

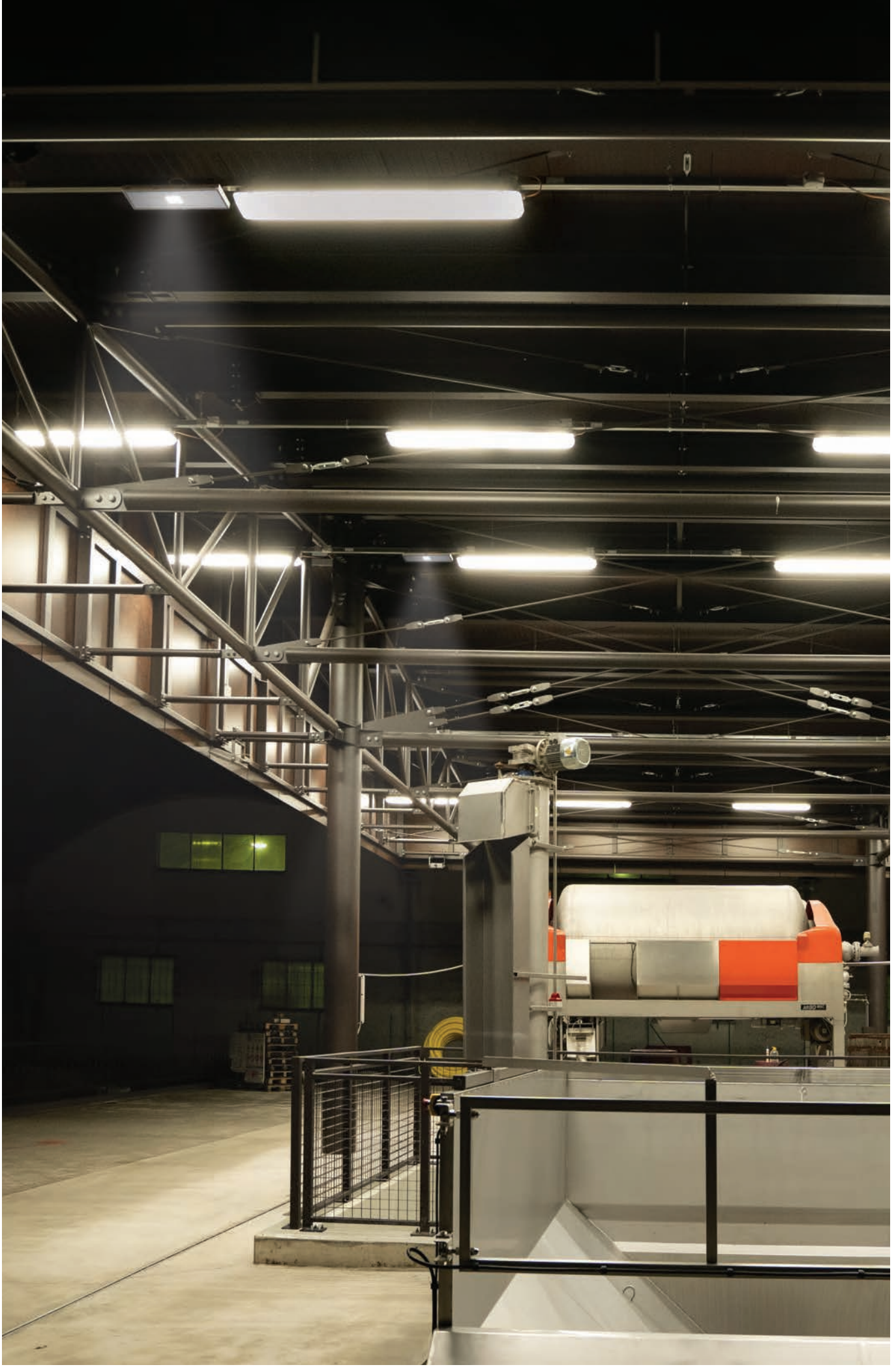

Formula 65

emergency



- Adjustable autonomy and possibility of an additional battery to double the flux and safety (Autoripara battery).
- Great flexibility thanks to multiple versions and accessories for all installation requirements.
- Housing with numerous pre-drilled inlets and direct fixing on junction box.

Applications

Industry, services

Characteristics

- Power supply*** 230VAC±10%, 50÷60Hz
- Mounting** Wall, ceiling, recessed, false ceiling
- Recharging time** 12h with LTO and LiFe batteries
- Housing** Polycarbonate, white RAL 9003
- Optics** Symmetrical, white
- Screen** Clear polycarbonate
- Compliance** EN 60598-1, EN 60598-2-2, EN 60598-2-22, UNI EN 1838, UNI 11222, EN62034

* LG230, LG24, HT systems consider the parameters of the control unit used

Dimensions mm				Distance of visibility (DV)	
L	B	H	H1	Wall	Edge mounting
VERSIONS LG230 - LG24 - HT230 AND WITH LiFe BATTERY					
354	152	63.4	26	25m	28m
LTO BATTERY VERSION					
354	152	48.5	26	25m	28m
NiMH-Cd BATTERY VERSION					
354	152	48.5	26	25m	28m

Performance according to EN 1838

Height (m)	Centre distance (m) ESCAPE ROUTES		Illuminated surface area (m) LARGE AREAS	
	Wall	Ceiling	Wall	Ceiling
2.5	11	-	8x12	-
3	-	18	-	10x16
7	-	25	-	14x20

Lighting >1lx at floor level along the centre line without reflections Emax/Emin <40

Lighting >0.5lx at floor level without reflections Emax/Emin <40

Performance with reference to luminaire **Order Code 19430** 1100 lm

Maintenance coefficient 0.8

FORMULA 65

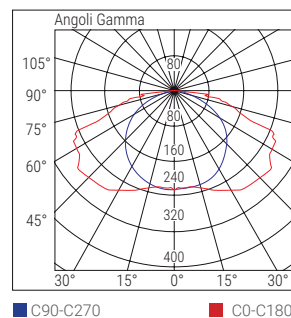

	Order Code	W eq.	Description	Version	Autonomy h	Battery	FLUX SE lm	AUTORIPARA Batt. OPTIONAL Flux SE lm	FLUX SA lm		Input power		Weight Kg	Packaging Single/ Multi pack	Conform.
									DC	AC	DC	AC			
TR	19200N	6	F65 LED 6W IP65 SE 1/3 LIFE	SE	1/3	LiFe 3,2V 0,5Ah	150/70	-			1,1W	0,4	1/6	STANDARD	
	19202N	8	F65 LED 8W IP65 SE 1/3 LIFE	SE	1/3	LiFe 3,2V 0,5Ah	200/80	-		1,1W	0,4	1/6			
	19204N	8	F65 LED 8W IP65 SA 1/3 LIFE	SA/SE	1/3	LiFe 3,2V 0,5Ah	200/80	-	160	2,5W	0,4	1/6			
	19206N	11	F65 LED 11W IP65 SE 1/3 LIFE	SE	1/3	LiFe 3,2V 1,5Ah	450/160	-		1,1W	0,6	1/6			
	19208N	11	F65 LED 11W IP65 SA 1/3 LIFE	SA/SE	1/3	LiFe 3,2V 1,5Ah	450/160	-	160	2,5W	0,6	1/6			
	19210N	24	F65 LED 24W IP65 SE 1/3 LIFE	SE	1/3	LiFe 3,2V 3Ah	700/240	-		1,1W	0,8	1/6			
	19212N	24	F65 LED 24W IP65 SA 1/3 LIFE	SA/SE	1/3	LiFe 3,2V 3Ah	700/240	-	160	2,5W	0,8	1/6			
	19430	36	F65 LED LI-FE SE	SE	1	LiFe 9.6V 1.5Ah	1500	-		1,1W	0,8	1/6			
19431	36	F65 LED LI-FE SA	SA/SE	1	LiFe 9.6V 1.5Ah	1500	-	300	3,8W	0,8	1/6				
AT	R0818	8	F65LED 8W IP65 AT AR SE123h RM	SE	1/2/3	NiCd 3.6V 0.75Ah	135/95/78	250/175/125			1.5W	0.4	1/12	AUTOTEST	
	R1124	11	F65LED11W IP65 AT AR SE123h RM	SE	1/2/3	NiCd 3.6V 0.75Ah	180/125/90	315/220/160			1.5W	0.4	1/12		
	R1124SA	11	F65LED11W IP65 AT AR SA123h RM	SA/SE	1/2/3	NiCd 3.6V 0.75Ah	180/125/90	315/220/160	250		4.5W	0.6	1/12		
	R2436	24	F65LED24W IP65 AT AR SE123h RM	SE	1/2/3	NiMH 3.6V 1.2Ah	315/220/160	550/385/275			1.5W	0.6	1/12		
	R2436SA	24	F65LED24W IP65 AT AR SA123h RM	SA/SE	1/2/3	NiMH 3.6V 1.2Ah	315/220/160	550/385/275	280		5.0W	0.6	1/12		
	19432	36	F65 LED LI-FE AT AR SE	SE	1/1.5/3*	LiFe 9.6V 1.5Ah	1200/830/450	2200/1650/900			7W	0.8	1/6		
	19433	36	F65 LED LI-FE AT AR SA	SA/SE/PS	1/1.5/3*	LiFe 9.6V 1.5Ah	1200/830/450	2200/1650/900	1000		13W	0.8	1/6		
AT-OPT	19290	8	F65LED 8W IP65 AT OPT SE8LTO	SE	1/1.5/2/3/8	LTO 4.8V 1.2Ah	250/170/130/85/35	-			7.5W	0.5	1/6	CENTRALISED SELF-TESTING	
	19291	11	F65LED 11W IP65 AT OPT SE8LTO	SE	1/1.5/2/3/8	LTO 4.8V 1.2Ah	315/210/160/110/45	-			7.5W	0.5	1/6		
	19292	24	F65LED 24W IP65 AT OPT SE8LTO	SE	1/1.5/2/3/8	2xLTO 4.8V 1.2Ah	550/370/280/190/80	-			7.5W	0.6	1/6		
	19293	24GL	F65LED 24GL IP65 AT OPT SE8LTO	SE	1/1.5/2/3/8	2xLTO 4.8V 1.2Ah	800/540/410/280/115	-			7.5W	0.6	1/6		
	19294	11	F65LED 11W IP65 AT OPT SA8LTO	SA/SE/PS	1/1.5/2/3/8	LTO 4.8V 1.2Ah	315/210/160/110/45	-	130		7.5W	0.5	1/6		
	19295	24	F65LED 24W IP65 AT OPT SA8LTO	SA/SE/PS	1/1.5/2/3/8	2xLTO 4.8V 1.2Ah	550/370/280/190/80	-	150		7.5W	0.6	1/6		
	19296	24GL	F65LED 24GL IP65 AT OPT SA8LTO	SA/SE/PS	1/1.5/2/3/8	2xLTO 4.8V 1.2Ah	800/540/410/280/115	-	200		7.5W	0.6	1/6		
	LG	Standalone luminaires with Centralised Diagnostics integrating the Module Order No. 15036													
	LGFM	Standalone luminaires with Centralised Radio Diagnostics integrating the Module Order Code 15037													
	DALI	Standalone luminaires with Dali Centralised Diagnostics integrating the Module Order Code 15038													

* The indicated autonomy doubles with the Autoripara battery, if the luminaire is set to LONG OPERATING TIME

Formula 65

emergency

	Order Code	W eq.	Description	Version	Autonomy h	Battery	FLUX SE lm	Batt. AUTORIPARA OPTIONAL Flux SE lm	FLUX SA lm	Input power DC	AC	Weight Kg	Packaging Single/Multi pack		
LG	19434	36	F65 LED LI-FE LG AR SE	SE	1/1.5/3*	LiFe 9.6V 1.5Ah	1200/830/450	2200/1650/900				7W	0.8	1/6	CENTRALTEST
	19435	36	F65 LED LI-FE LG AR SA	SA/SE/PS	1/1.5/3*	LiFe 9.6V 1.5Ah	1200/830/450	2200/1650/900	1000		13W	0.8	1/6		
	LGFM	Standalone luminaires with Centralised Radio Diagnostics integrating the Module Order Code 15037													
	DALI	Standalone luminaires with Dali Centralised Diagnostics integrating the Module Order Code 15038													
LG230	31124	8	F65 LED 8W LG230						400	4.1W	8.5VA	0.6	1/6	CENTRALISED BATTERY	
	31125	11	F65 LED 11W LG230 LS-UV						600	6.4W	8.1VA	0.6	1/6		
	31150	24	F65 LED 24W LG230 LS-UV						1000	10.4W	12VA	0.6	1/6		
	31122	36	F65 LED 36W LG230 LS-UV						1600	15W	15.9VA	0.6	1/6		
LG24	32094	8	F65 LED 8W LGS24				400			3.8W		0.6	1/6	CENTRALISED BATTERY	
	32091	36	LED 36W LGS24 LS-UV				400		1600	4.3W	15.2VA	0.6	1/6		
HT230	17435	8	F65 LED 8W HT IP65						400	4.4W	8.9VA	0.6	1/6	CENTRALISED BATTERY	
	17436	11	F65 LED 11W HT IP65						600	6.1W	6.4VA	0.6	1/6		
	17437	24	F65 LED 24W HT IP65						1000	10.2W	10.4VA	0.6	1/6		
	17438	36	F65 LED 36W HT IP65						1600	14.3W	14.5VA	0.6	1/6		

* The indicated autonomy doubles with the Autoripara battery, if the luminaire is set to LONG OPERATING TIME

ACCESSORIES - included

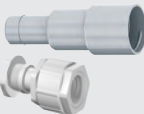

CONDUIT ADAPTER 16/20 mm WHITE
Mounting with a Ø16 or Ø20 mm conduit

CABLE CONDUIT GLAND M20



LH/RH/DOWN STICKERS
SA versions only

Order Code **19044**



RECESSED BOX + FRAMES
For recessed mounting

Order Code **19040** (Versions with LTO, NiMh, NiCd battery)

ACCESSORIES - to be ordered separately



AR - AUTORIPARA BATTERY
Compatible with Order Code **R0818 - R1124 - R1124SA R2436 - R2436SA**
Order Code **RA01** - NiMh 3.6V 1.2Ah



EDGE MOUNTING WALL BRACKET

Order Code **19045**



AR - AUTORIPARA BATTERY
Compatible with Order Code **19432 - 19433 - 19434 19435**
Order Code **RA06** - LIFE 9.6V 1.5Ah



PROTECTIVE GRILLE
Dimensions 440x215x99 mm

Order Code **3912**



RECESSED BOX + FRAMES
For recessed mounting

Order Code **19048** (Versions LG230, LG24, HT230 and LiFe battery)



LG - LGFM - DALI MODULE

LG - Order Code **15036** (with LTO battery only)
LGFM - Order Code **15037** (with LiFe and LTO battery only)
DALI - Order Code **15038** (with LiFe and LTO battery only)



EX FALSE CEILING BRACKET
Recessed mounting hole: 370 x 130 mm

Order Code **19041** (Vers. with LTO, NiMh, NiCd battery)
Order Code **19049** (Vers. LG230, LG24, HT230 and LiFe battery)



LG INIBIT REMOTE CONTROL
RM only for LG versions and Codes 19432 - 19433

Order Code **12101**

LG



EDGE MOUNTED SCREENS
Screen printing on clear polycarbonate

Order Code **19042** (LH/RH)
Order Code **19043** (DOWN)



RM INIBIT REMOTE CONTROL
RM only for Codes R0818 - R1124 - R1124SA R2436 - R2436SA

Order Code **2730**

RM



Pratica IP65

emergency



IP65 luminaire particularly resistant to mechanical stress and weathering.



Innovative lens with RTI technology to increase mounting spacing and standardise pictogram illumination.



Housing equipped with many pre-drilled inlets, and accessories for $\varnothing 16$ and $\varnothing 20$ mm pipe inlets such as the PG16/20 adapter and the IP Plug membranes supplied.

Applications

Industry, outdoors, services

Characteristics

Power supply 230VAC $\pm 10\%$, 50÷60Hz

Mounting Recessed, wall, ceiling, edge mounting, suspended, electrified track

Recharging time 12h

Housing Polycarbonate, white RAL 9003

Optics PMMA lens with RTI technology (Total Internal Reflection)

Housing Polycarbonate, white RAL 9003

Compliance EN 60598-1, EN 60598-2-2, EN 60598-2-22, UNI EN 1838, UNI 11222, EN 62034.

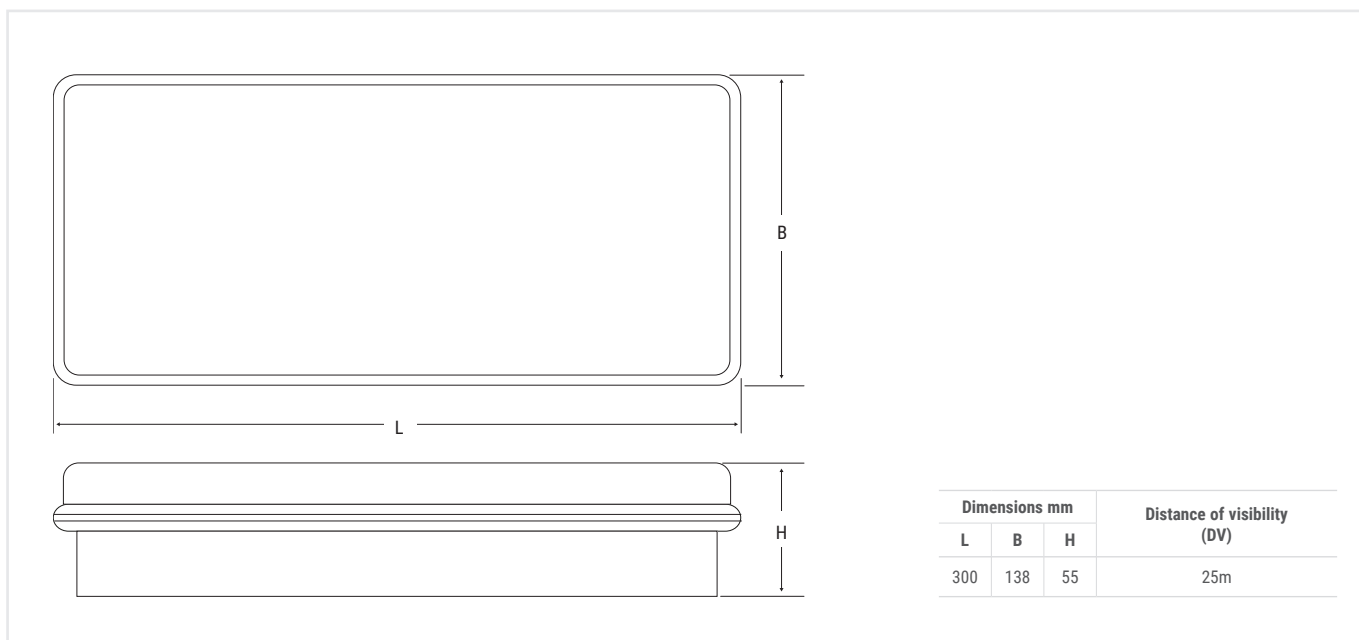

028

Performance according to EN 1838

Height (m)	Centre distance (m) ESCAPE ROUTES		Illuminated surface area (m) LARGE AREAS	
	Wall	Ceiling	Wall	Ceiling
2.5	8	-	4x6	-
3	-	9	-	6x7

Lighting >1lx at floor level along the centre line without reflections Emax/Emin <40

Lighting >0.5lx at floor level without reflections Emax/Emin <40

Performance with reference to luminaire **Order Code 250SE** 250 lm Maintenance coefficient 0.8

PRATICA IP65

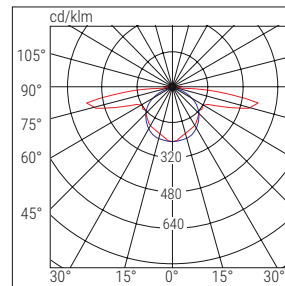

■ C90-C270

■ C0-C180

	Order Code	W eq.	Description	Version	Autonomy h	Battery	FLUX SE lm	FLUX SA lm	Input power		Weight Kg	Packaging Single/ Multi pack
									DC	AC		
TR	250SE	18	PRATICA 300LM 1.5/3h IP65 SETR	SE	1.5/3	LiFe 3.2V 1.5 Ah	300/160			1.2 W	1	1/12
	250SA	18	PRATICA 300LM 1.5/3h IP65 SATR	SA/SE	1.5/3	LiFe 3.2V 1.5 Ah	300/160	200		2.5 W	0.8	1/12
	500SE	24	PRATICA 500LM 1.5/3h IP65 SETR	SE	1.5/3	LiFe 3.2V 3Ah	500/250			1.2 W	1.1	1/12
	500SA	24	PRATICA 500LM 1.5/3h IP65 SATR	SA/SE	1.5/3	LiFe 3.2V 3Ah	500/250	200		2.5 W	0.9	1/12
AT	250ATSE	18	PRATICA 300LM 1.5/3h IP65 SEAT	SE	1.5/3	LiFe 3.2V 1.5 Ah	300/160			2.6 W	1	1/12
	250ATSA	18	PRATICA 300LM 1.5/3h IP65 SAAT	SA/SE	1.5/3	LiFe 3.2V 1.5 Ah	300/160	200		4.8 W	0.8	1/12
	500ATSE	24	PRATICA 500LM 1.5/3h IP65 SEAT	SE	1.5/3	LiFe 3.2V 3 Ah	500/250			2.6 W	1.1	1/12
	500ATSA	24	PRATICA 500LM 1.5/3h IP65 SAAT	SA/SE	1.5/3	LiFe 3.2V 3 Ah	500/250	200		4.8 W	0.9	1/12

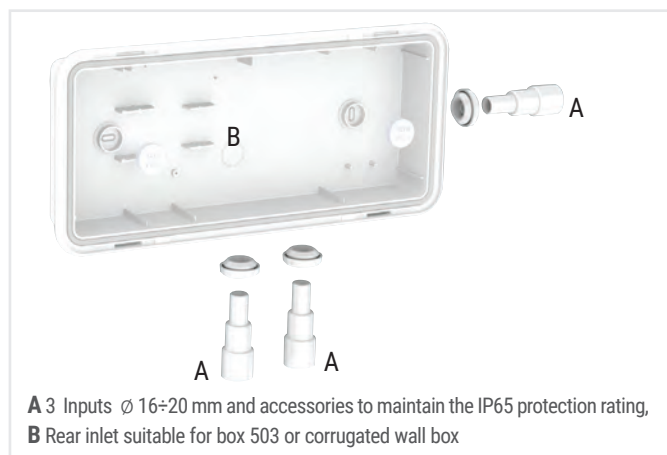

ACCESSORIES - included



CONDUIT ADAPTER 16/20 mm WHITE
2 CABLE GLAND MEMBRANES IP65
 Mounting with a $\varnothing 16$ or $\varnothing 20$ mm conduit



LH/RH/DOWN/UP STICKERS
 SA versions only
 Order Code **4117**

ACCESSORIES - to be ordered separately



SUSPENDED MOUNTING HOOKS
 Order Code **3723**

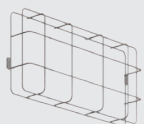

PROTECTIVE GRILLE
 Dimensions 440x215x99 mm
 Order Code **3912**

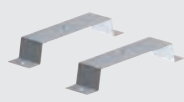

FALSE CEILING BRACKET
 Order Code **2751**



RM INIBIT REMOTE CONTROL
 For RM versions
 Order Code **2730**



RECESSED BOX
 Order Code **2742**



RM MODULE
 RM
 Order Code **15048**



SCREENS
 Order Code **4124** (LH/RH)
 Order Code **4125** (DOWN)
 Order Code **4126** (UP)



LH/RH/DOWN/UP STICKERS
 Order Code **4117**

Pratica IP42

emergency



- IP42
- IK07
- 850°
-
- Batt. LiFe
- +40°C
0°C



Luminaire suitable for both emergency lighting and signage, thanks to the pictograms provided. Housing built to withstand outdoor use, equipped with LiFe battery and a 5-year warranty.



Unique luminaire with SE and SA function, with adjustable autonomy from 1 to 3hrs.



Large spaces inside the product facilitate wiring and maintenance. The housing is equipped with 3 x ø16 pre-drilled inlets and can be installed over a 503 box. Recessed box supplied.

Applications

Services, commercial activities, shops, restaurants, offices

Characteristics

Power supply 230VAC ± 10%, 50÷60Hz

Mounting Wall, ceiling, recessed, suspended, electrified track

Recharging time 12h with LiFe battery

Housing Polycarbonate, white RAL 9003

Screen Clear polycarbonate

Compliance EN 60598-1, EN 60598-2-2, EN 60598-2-22, UNI EN 1838, UNI 11222, EN 62034

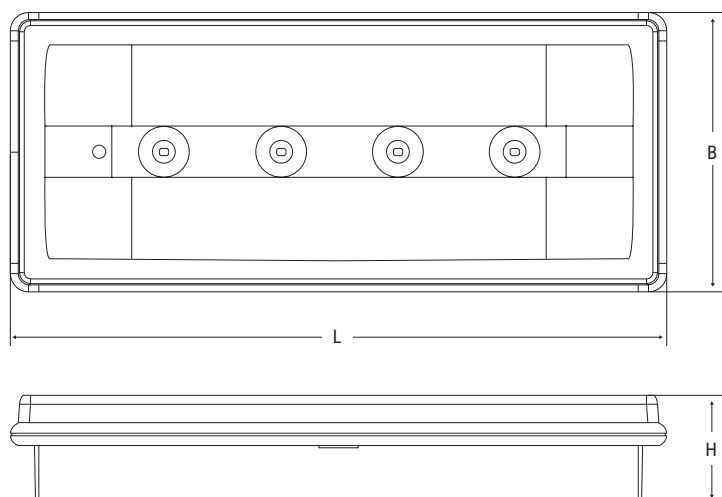

Dimensions mm			Distance of visibility (DV)
L	B	H	
280	119	46	21m

Performance according to EN 1838

Height (m)	Centre distance (m) ESCAPE ROUTES		Illuminated surface area (m) LARGE AREAS	
	Wall	Ceiling	Wall	Ceiling
2.5	5	-	3x3	-
3	-	8	-	6x6
Lighting >1lx at floor level along the centre line without reflections Emax/Emin <40			Lighting >0.5lx at floor level without reflections Emax/Emin <40	
Performance with reference to luminaire Order Code 4400 100 lm			Maintenance coefficient 0.8	

PRATICA IP42

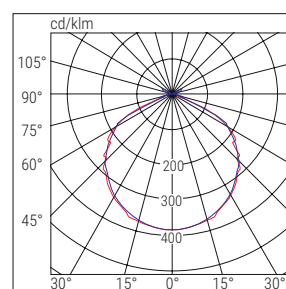

■ C0-C180 ■ C90-C270

	Order Code	W eq.	Description	Version	Autonomy h	Battery	FLUX SE lm	FLUX SA lm	Input power		Weight Kg	Packaging Single/Multi pack
									DC	AC		
TR	4400	11	PRATICA 200LM 1/1.5/3h IP42 SATR	SA/SE	1/1.5/3	LiFe 3.2V 0.5Ah	200/160/100	100	1.4 W	0.25	1/12	STANDARD
	4401	18	PRATICA 300LM 1.5/3h IP42 SATR	SA/SE	1.5/3	LiFe 3.2V 1.5Ah	300/160	200	2.5 W	0.3	1/12	
	4402	24	PRATICA 500LM 1.5/3h IP42 SATR	SA/SE	1.5/3	LiFe 3.2V 3Ah	500/250	200	2.5 W	0.35	1/12	
AT	4403	11	PRATICA 200LM 1/1.5/3h IP42 SAAT	SA/SE	1/1.5/3	LiFe 3.2V 0.5Ah	200/160/100	100	1.4 W	0.25	1/12	AUTOTEST
	4404	18	PRATICA 300LM 1.5/3h IP42 SAAT	SA/SE	1.5/3	LiFe 3.2V 1.5Ah	300/160	200	4.8 W	0.3	1/12	
	4405	24	PRATICA 500LM 1.5/3h IP42 SAAT	SA/SE	1.5/3	LiFe 3.2V 3Ah	500/250	200	4.8 W	0.35	1/12	

ACCESSORIES - included

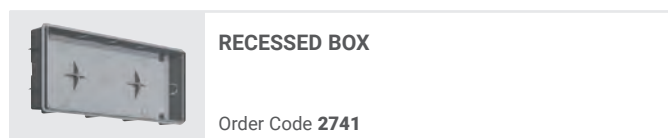
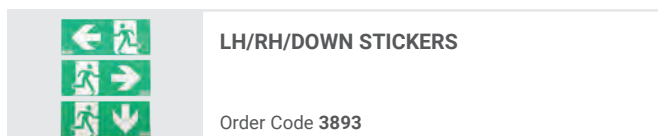

ACCESSORIES - to be ordered separately

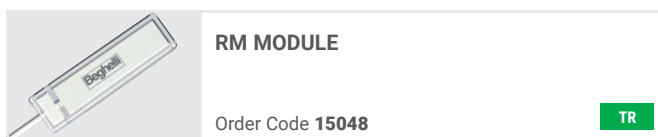
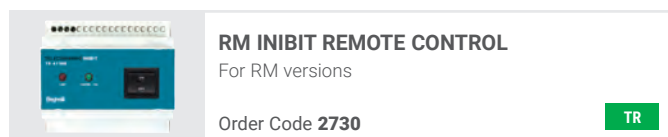
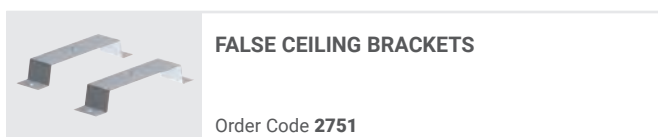
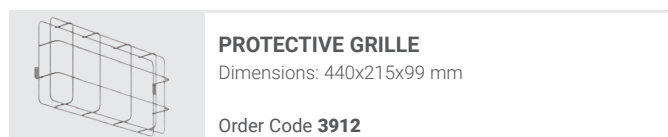
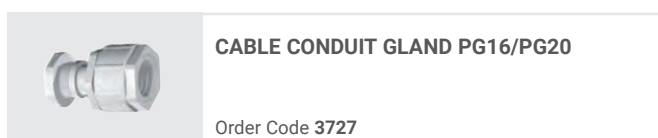
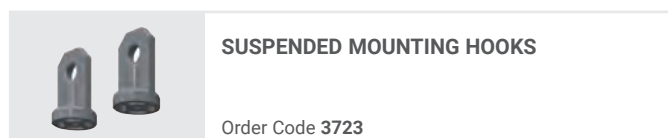

Ticinque

emergency



IP65

IP42

IK07

850°



Batt. LiFe

+40°C
0°C



High autonomy luminaire, up to 8hrs. In the Granluce version, the flux is up to 1,250 lm, with a set autonomy of 1h. Also suitable for special applications where high luminous fluxes are required (10lx with an autonomy of 90 min).



Available in both IP42 and IP65 protection ratings; with pictograms installed, the distance of visibility is 28m.



Easy installation thanks to the PG16/20 quick connector and the supplied IP Plug membranes. Quick connection on all 4 sides while maintaining the IP65 protection rating, even on an electrified track.

Applications

Industry, services, shopping centres

Characteristics

Power supply 230VAC ± 10%, 50÷60Hz

Mounting Wall, ceiling

Recharging time 12h

Housing Polycarbonate, white RAL 9003

Optics Symmetrical, white

Screen Clear polycarbonate

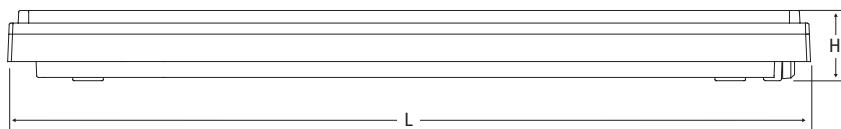
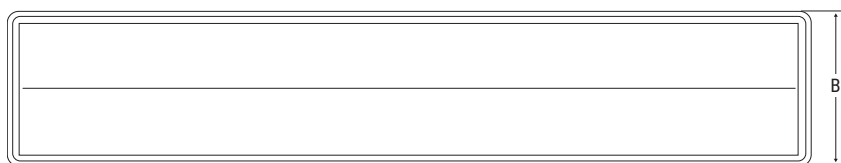

Compliance EN 60598-1, EN 60598-2-22, UNI EN 1838, UNI 11222, EN 62034



Dimensions mm			Distance of visibility (DV)
L	B	H	
549	147	43	28m

032

Performance according to EN 1838

Height (m) 	Centre distance (m) ESCAPE ROUTES 		Illuminated surface area (m) LARGE AREAS 	
	Wall	Ceiling	Wall	Ceiling
2.5	8	-	8x8	-
3	-	16	-	11x11
7	-	22	-	14x14
Lighting >1lx at floor level along the centre line without reflections Emax/Emin <40			Lighting >0.5lx at floor level without reflections Emax/Emin <40	
Performance with reference to luminaire Order Code 8590 800 lm			Maintenance coefficient 0.8	

TICINQUE

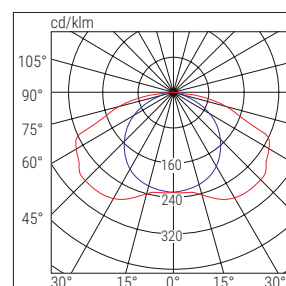

■ C90-C270 ■ C0-C180

	Order Code	W eq.	Description	Version	Autonomy h	Battery	FLUX SE lm	FLUX SA lm	Input power		Weight Kg	Packaging Single/ Multi pack	Notes
									DC	AC			
TR	8584	18	TICINQUE IP42 LED 18WSE8P	SE	8	LiFe 9.6V 1.5 Ah	260			2W	1.8	1/6	IP42
	8585	18	TICINQUE IP42 LED 18WSA8P	SA/SE	8	LiFe 9.6V 1.5 Ah	260	180		4W	1.8	1/6	IP42
	8586	18	TICINQUE IP65 LED 18WSE8P	SE	8	LiFe 9.6V 1.5 Ah	260			2W	1.8	1/6	IP65
	8587	18	TICINQUE IP65 LED 18WSA8P	SA/SE	8	LiFe 9.6V 1.5 Ah	260	180		4W	1.8	1/6	IP65
	8590	24	GRANLUCE T5LED IP65 SE2h	SE	2	LiFe 9.6V 1.5 Ah	800			5W	2	1/6	IP65
	8591	24	GRANLUCE T5LED IP65 SA2h	SA/SE	2	LiFe 9.6V 1.5 Ah	800	180		8W	2	1/6	IP65
	8597	24	GRANLUCE T5LED IP65 SE1h	SE	1	LiFe 9.6V 1.5 Ah	1500			5W	2	1/6	IP65
	8598	24	GRANLUCE T5LED IP65 SA1h	SA/SE	1	LiFe 9.6V 1.5 Ah	1500	180		8W	2	1/6	IP65
AT	8592	24	GRANLUCE T5LED AT IP65 SE123h	SE	1/2/3	LiFe 9.6V 1.5 Ah	1250/800/550			5W	2	1/6	IP65
	8593	24	GRANLUCE T5LED AT IP65 SA123h	SA/SE	1/2/3	LiFe 9.6V 1.5 Ah	1250/800/550	400		15W	2	1/6	IP65

ACCESSORIES - included

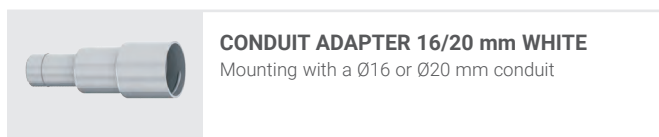
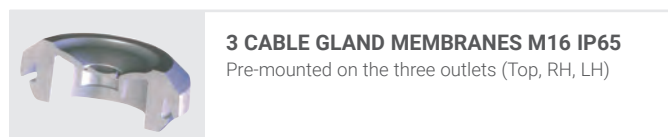

ACCESSORIES - to be ordered separately

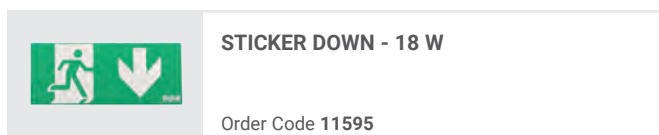
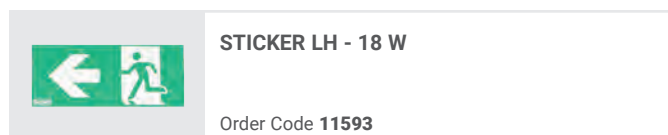
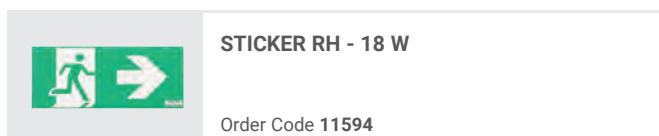
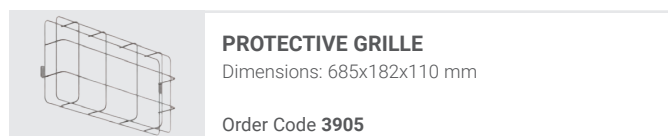

Ticinque TuttoLED

emergency



IP65

IP42

IK07

850°



Batt. LiFe

+40°C
0°C



Autonomy up to 5hrs, luminous flux up to 400lm.



Available in both IP42 and IP65 protection ratings; with pictograms installed, the distance of visibility is 28m.



Equipped with PG16/20 quick connector and IP Plug membranes for quick connections on all 4 sides.

Applications

Industry, services

Characteristics

Power supply 230VAC \pm 10%, 50÷60Hz

Mounting Wall, ceiling

Recharging time 12h

Housing Polycarbonate, grey RAL 7035

Optics Symmetrical, white

Screen Clear polycarbonate

Compliance EN 60598-1, EN 60598-2-22, UNI EN 1838, UNI 11222, EN 62034

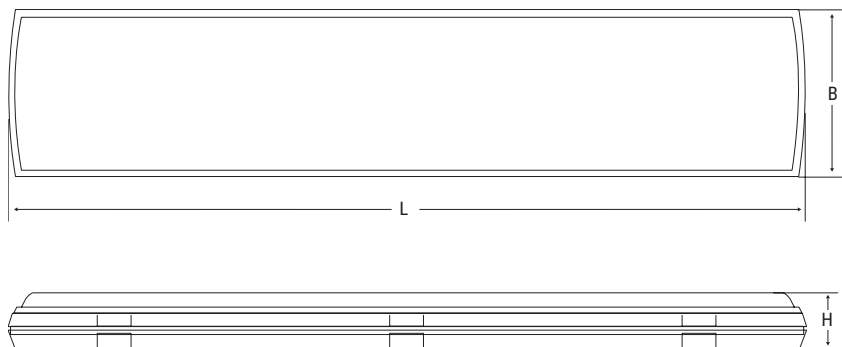

Dimensions mm			Distance of visibility (DV)
L	B	H	
610	128	54	28m

034

Performance according to EN 1838

Height (m)	Centre distance (m) ESCAPE ROUTES		Illuminated surface area (m) LARGE AREAS	
	Wall	Ceiling	Wall	Ceiling
2.5	7	-	6x6	-
3	-	12	-	9x9
Lighting >1lx at floor level along the centre line without reflections Emax/Emin <40			Lighting >0.5lx at floor level without reflections Emax/Emin <40	
Performance with reference to luminaire Order Code 8595 400 lm			Maintenance coefficient 0.8	

TICINQUE TUTTOLED

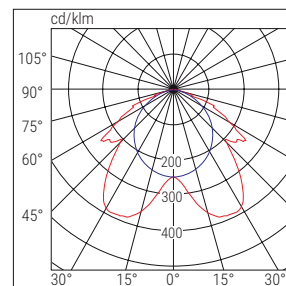

■ C90-C270

■ C0-C180

	Order Code	W eq.	Description	Version	Autonomy h	Battery	FLUX SE lm	FLUX SA lm	Input power		Weight Kg	Packaging Single/Multi pack	Notes
									DC	AC			
TR	8594	18	TICINQUETUTTOLED IP42 18SE5P	SE	5	LiFe 9.6V 1.5Ah	400	-	5W	1.8	1/6	IP42	STANDARD
	8596	18	TICINQUETUTTOLED IP65 18SA5P	SA/SE	5	LiFe 9.6V 1.5Ah	400	220	8W	2.0	1/6	IP65	
	8595	18	TICINQUETUTTOLED IP65 18SE5P	SE	5	LiFe 9.6V 1.5Ah	400	-	5W	2.0	1/6	IP65	

ACCESSORIES - included

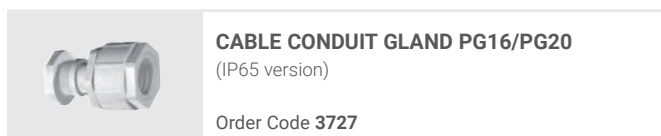
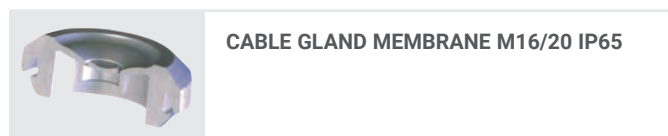

ACCESSORIES - to be ordered separately

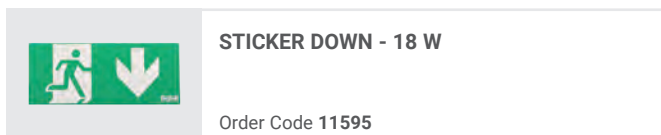
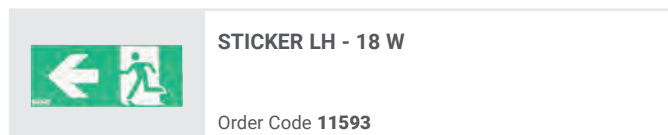
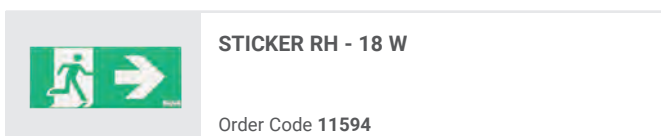
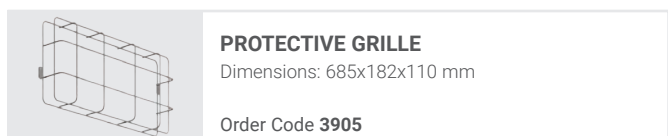



UP LED

emergency



 Compact design with only 2 cm thickness. Luminous flux up to 450 lm. Version with a fast-charging Titanium Battery (LTO), with 10 years of service life and for extreme working temperatures.

 Adjustable autonomy from 1.5 to 8hrs. All accessories are available for special mounting, such as the three-phase track kit.

 Optical system with 4 transparent lenses to maximise illumination. The 824 version installs opal lenses for a more diffuse illumination.

Applications

Industry, services, hospitals, schools, residential

Characteristics

Power supply

UP LED: 230Vac ± 10%, 50÷60Hz

UP LED 824: 230Vac ± 10%, 50÷60Hz, 120Vac ± 10%, 50÷60Hz

Mounting Wall, ceiling, three-phase track

Recharging time 12hrs with LTO battery

Housing Polycarbonate, white RAL 9003

Optics Clear polycarbonate lenses

Screen Clear polycarbonate

Compliance EN 60598-1, EN 60598-2-22, UNI EN 1838, UNI 11222, EN 62034

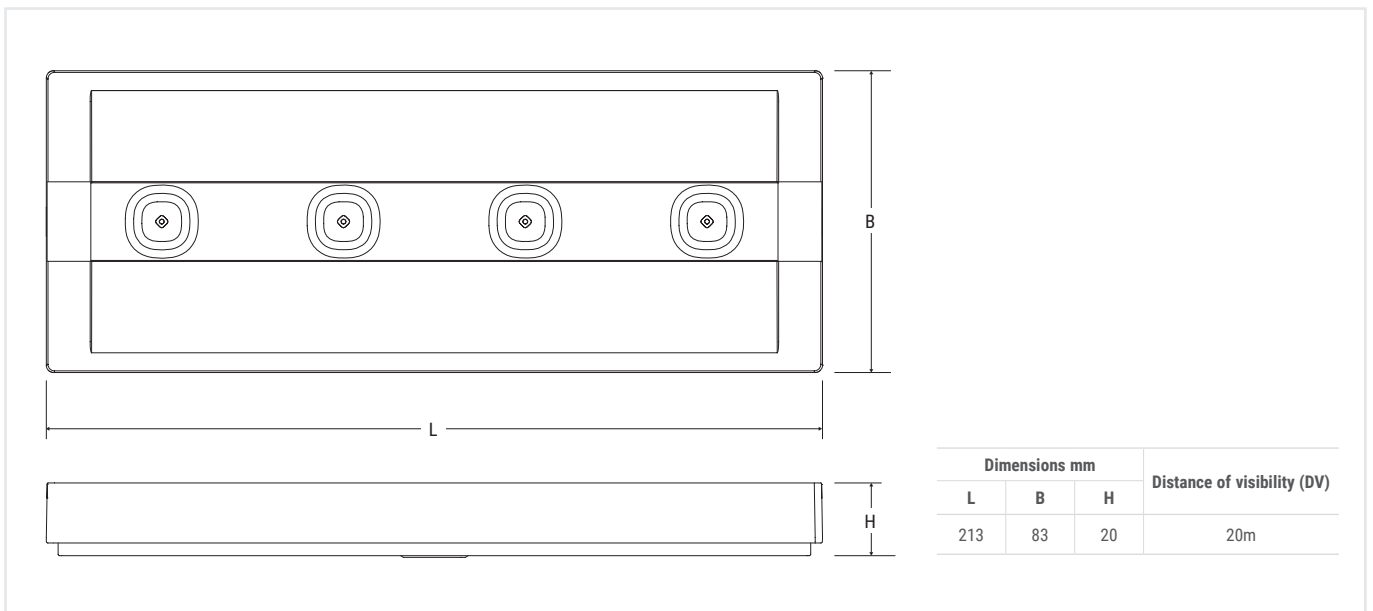

Performance according to EN 1838

Height (m)	Centre distance (m) ESCAPE ROUTES		Illuminated surface area (m) LARGE AREAS	
	Wall	Ceiling	Wall	Ceiling
2.5	8	-	5x6	-
3	-	15	-	14x14
Lighting >1lx at floor level along the centre line without reflections Emax/Emin <40			Lighting >0.5lx at floor level without reflections Emax/Emin <40	
Performance with reference to luminaire Order Code 4304 450 lm			Maintenance coefficient 0.8	

UP LED

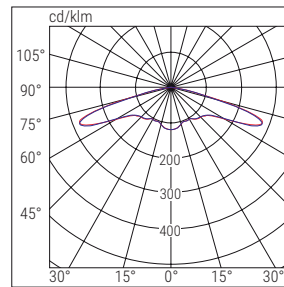

UP LED 824

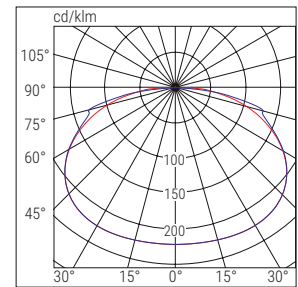

■ C90-C270 ■ C0-C180 ■ C0-C180 ■ C90-C270

	Order Code	W eq.	Description	Version	Autonomy h	Battery	FLUX SE lm	FLUX SA lm	Input power		Weight Kg	Packaging Single/Multi pack
									DC	AC		
TR	4300	6-8	UP LED 6-8W SE 1/2/3N IP65 RM	SE	1/2/3	NiCd 3.6V 0.75 Ah	240/140/95	-	0.8W	0.25	12	STANDARD
	4301	11-24	UP LED 11-24W SE 1/2/3h IP65 RM	SE	1/2/3	NiMh 3.6V 1.2 Ah	340/195/130	-	0.8W	0.25	12	
	4302	24-36	UP LED 24-36W SE 1/2/3h IP65 RM	SE	1/2/3	NiMh 3.6V 1.5 Ah	450/240/170	-	1.2W	0.27	12	
	4303	11-24	UP LED 11-24W SA 1/2/3h IP65 RM	SA/SE	1/2/3	NiMh 3.6V 1.2 Ah	340/195/130	180	3.0W	0.25	12	
	4304	24-36	UP LED 24-36W SA 1/2/3h IP65 RM	SA/SE	1/2/3	NiMh 3.6V 1.5 Ah	450/240/170	240	3.5W	0.27	12	
	824S	24	UP LED 824S SE 100L 120° RM	SE	2	NiCd 3.6V 0.75Ah	100	-	0.8W	0.25	1/12	
	824M	24	UP LED 824M SE 150L 90° RM	SE	1.5	NiCd 3.6V 0.75Ah	150	-	0.8W	0.25	1/12	
	824L	24	UP LED 824L SE 250L 90° RM	SE	1.5	NiMH 3.6V 1.2A	250	-	0.8W	0.25	1/12	
	824MSA	24	UP LED 824M SA 150L 90° RM	SA/SE	1.5	NiCd 3.6V 0.75Ah	150	100	2.0W	0.25	1/12	
824LSA	24	UP LED 824L SA 250L 90° RM	SA/SE	1.5	NiMH 3.6V 1.2A	250	100	2.0W	0.25	1/12		
AT - OPT	4370	11-24	UPLD 1124W IP65 AT OPT SE8LTO	SE	1/1.5/2/3/8	LTO 4.8V 0.5Ah	250/170/130/85/35	-	7.5W	0.3	1/12	CENTRALISED SELF-TESTING
	4371	24-36	UPLD 2436W IP65 AT OPT SE8LTO	SE	1/1.5/2/3/8	LTO 4.8V 1Ah	450/305/230/155/65	-	7.5W	0.3	1/12	
	4372	11-24	UPLD 1124W IP65 AT OPT SA8LTO	SA/SE	1/1.5/2/3/8	LTO 4.8V 0.5Ah	250/170/130/85/35	110	7.5W	0.3	1/12	
	4373	24-36	UPLD 2436W IP65 AT OPT SA8LTO	SA/SE	1/1.5/2/3/8	LTO 4.8V 1Ah	450/305/230/155/65	200	7.5W	0.3	1/12	
	LG	Standalone luminaires with Centralised Diagnostics integrating the Module Order No. 15036										
	LGFM	Standalone luminaires with Centralised Radio Diagnostics integrating the Module Order Code 15037										
	DALI	Standalone luminaires with Dali Centralised Diagnostics integrating the Module Order Code 15038										

ACCESSORIES - to be ordered separately



LH/RH/DOWN/UP SCREENS
Label on opal polycarbonate
Order Code **4326**



IP65 ACCESSORY KIT
Cable gland, 2 plugs, perimeter seal
Only required for IP65 rating in 824 versions
Order Code **4318**



EDGE MOUNTED SCREEN
Order Code **4325**

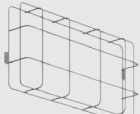

PROTECTIVE GRILLE
Dimensions: 305x110x100 mm
Order Code **3903**



LG - LGFM - DALI MODULE (AT-OPT version only)
LG - Order Code **15036**
LGFM - Order Code **15037**
DALI - Order Code **15038**



THREE-PHASE TRACK KIT
Order Code **4319**



RM INIBIT REMOTE CONTROL
For TR versions
Order Code **2730**

ACCESSORIES - included



IP65 ACCESSORY KIT
Cable gland, 2 plugs, perimeter seal
Excluding version 824
Order Code **4318**

Completa

emergency



With enclosure With enclosure

IP40 IK07 IP66 IK09 850° □

Batt. LTO Batt. NiMH Batt. NiCd

+45°C / -20°C +40°C / 0°C +40°C / 0°C



Adjustable autonomy from 1 to 8 hrs. Version with a fast-charging Titanium Battery (LTO) for extreme working temperatures. **IK09** rating with optional IP66 enclosure, with **a mechanical resistance up to 5 times greater than that of a standard luminaire.**



The extensive range of accessories allows one luminaire to be used for recessed, ceiling, edge mounting and plasterboard applications. IP66 IK09 enclosure for harsh environments.



Recessed mounting with separated body of the diffuser/reflector unit, which remains integrated with the electronics and can be quickly installed in the recessed box provided.

Applications

Industry, services

Characteristics

Power supply

230Vac ± 10%, 50÷60Hz

Mounting: Wall, ceiling, recessed, false ceiling, edge mounting and wall signage

Recharging time 12hrs with LTO battery

Housing Polycarbonate, white RAL 9003

Optics Symmetrical, white

Screen Clear polycarbonate

Compliance EN 60598-1, EN 60598-2-2, EN 60598-2-22, UNI EN 1838, UNI 11222, EN 62034

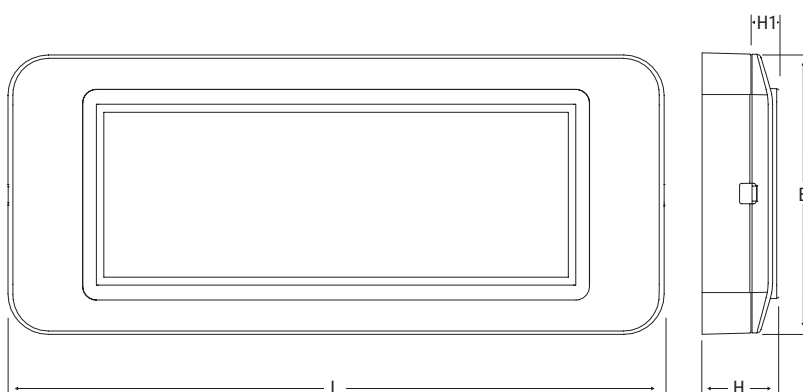

Dimensions mm				Distance of visibility (DV)	
L	B	H	H1	Wall	Edge mounting
CEILING					
294	126	34	-	15m	20m
RECESSED					
292	124	35	12	15m	20m
IP65 ENCLOSURE					
317	149	46	-	15m	20m

Performance according to EN 1838

Height (m)	Centre distance (m) ESCAPE ROUTES		Illuminated surface area (m) LARGE AREAS	
	Wall	Ceiling	Wall	Ceiling
2.5	6	-	4x6	-
3	-	11	-	8x8
Lighting >1lx at floor level along the centre line without reflections Emax/Emin <40			Lighting >0.5lx at floor level without reflections Emax/Emin <40	
Performance with reference to luminaire Order Code 4108 225 lm			Maintenance coefficient 0.8	

COMPLETA

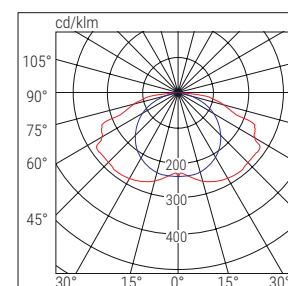

■ C90-C270

■ C0-C180

	Order Code	W eq.	Description	Version	Autonomy h	Battery	FLUX SE lm	FLUX SA lm	Input power		Weight Kg	Packaging Single/Multi pack	Conform.
									DC	AC			
TR	4101N	6	COMPLETA LED 6W SE 1/3 LIFE	SE	1/3	LiFe 3,2V 0,5Ah	150/70	-	1.1W	0.5	1/6	STANDARD	
	4102N	8	COMPLETA LED 8W SE 1/3 LIFE	SE	1/3	LiFe 3,2V 0,5Ah	200/80	-	1.1W	0.5	1/6	STANDARD	
	4103N	11	COMPLETA LED 11W SE 1/3 LIFE	SE	1/3	LiFe 3,2V 1,5Ah	500/180	-	1.1W	0.6	1/6	STANDARD	
	4105N	11	COMPLETA LED 11W SA 1/3 LIFE	SA/SE	1/3	LiFe 3,2V 1,5Ah	500/180	160	2,5W	0.6	1/6	STANDARD	
	4108N	24	COMPLETA LED 24W SE 1/3 LIFE	SE	1/3	LiFe 3,2V 1,5Ah	700/240	-	1.1W	0.6	1/6	STANDARD	
	4110N	24	COMPLETA LED 24W SA 1/3 LIFE	SA/SE	1/3	LiFe 3,2V 1,5Ah	700/240	160	2,5W	0.6	1/6	STANDARD	
AT - OPT	4200	8-11	CPLED 811W IP40 AT OPT SE 8LT	SE	1/1.5/2/3/8	LTO 4.8V 0.5Ah	150/100/75/55/25	-	7.5W	0.5	1/6	CENTRALISED SELF-TESTING	
	4201	11-24	CPLED 1124W IP40 AT OPT SE 8LT	SE	1/1.5/2/3/8	LTO 4.8V 0.5Ah	250/170/130/85/35	-	7.5W	0.5	1/6	CENTRALISED SELF-TESTING	
	4202	24-36	CPLED 2436W IP40 AT OPT SE 8LT	SE	1/1.5/2/3/8	2xLTO 4.8V 0.5Ah	450/305/230/156/65	-	7.5W	0.5	1/6	CENTRALISED SELF-TESTING	
	4203	11-24	CPLED 1124W IP40 AT OPT SA 8LT	SA/SE	1/1.5/2/3/8	LTO 4.8V 0.5Ah	250/170/130/85/35	110	7.5W	0.5	1/6	CENTRALISED SELF-TESTING	
	4204	24-36	CPLED 2436W IP40 AT OPT SA 8LT	SA/SE	1/1.5/2/3/8	2xLTO 4.8V 0.5Ah	450/305/230/156/65	200	7.5W	0.5	1/6	CENTRALISED SELF-TESTING	
	LG	Standalone luminaires with Centralised Diagnostics integrating the Module Order No. 15036											
	LGFM	Standalone luminaires with Centralised Radio Diagnostics integrating the Module Order Code 15037											
	DALI	Standalone luminaires with Dali Centralised Diagnostics integrating the Module Order Code 15038											

NEXT >

Completa

emergency

ACCESSORIES - included



LH/RH/DOWN STICKERS

Order Code **4278**



RECESSED BOX

Order Code **3733**

ACCESSORIES - to be ordered separately



IP66 - IK09 ENCLOSURE KIT

To achieve a mechanical resistance up to 5 times greater than that of standard luminaires (IK07)

Order Code **4112**



DOWN EDGE MOUNTED SCREEN

Screen printing on clear polycarbonate

Order Code **4268**

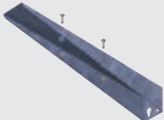

WALL BRACKET X EDGE MOUNTING

Order Code **4265**



LH/RH EDGE MOUNTED SCREENS

Screen printing on clear polycarbonate

Order Code **4267**



FALSE CEILING BRACKET

Order Code **4266**



LH/RH/DOWN SCREENS

Screen printing on opal polycarbonate

Order Code **4269**



LG - LGFM - DALI MODULE (AT-OPT version only)

LG - Order Code **15036**

LGFM - Order Code **15037**

DALI - Order Code **15038**

LG **LGFM** **DALI**



PROTECTIVE GRILLE

Dimensions: 440x215x98,7 mm

Order Code **3912**



Stile In

emergency



Luminaire designed for recessed mounting, with an autonomy of up to more than 8 hrs.



The extensive range of accessories allows one luminaire to be used for recessed, edge mounting and plasterboard applications.



For recessed mounting, a box is provided; for ceiling mounting, the housing is pre-fitted with several pre-drilled inlets to allow the entry of wire ways from all directions.

Applications

Services, commercial activities, shops, restaurants, offices

Characteristics

Power supply 230VAC \pm 10%, 50÷60Hz

Mounting Wall, ceiling, recessed, false ceiling, edge mounting

Recharging time 12h with LiFe battery

Housing Polycarbonate, white RAL 9003

Optics symmetrical, polycarbonate, white

Screen Clear polycarbonate

Compliance EN 60598-1, EN 60598-2-2, EN 60598-2-22, UNI EN 1838, UNI 11222, EN 62034

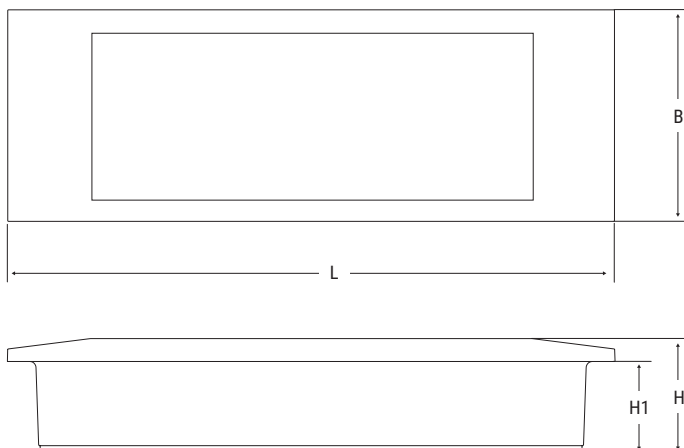

Dimensions mm				Distance of visibility (DV)	
L	B	H	H1	screen	edge mounting
292	102	55.5	44.5	15m	20m

Performance according to EN 1838

Height (m)	Centre distance (m) ESCAPE ROUTES		Illuminated surface area (m) LARGE AREAS	
	Wall	Ceiling	Wall	Ceiling
2.5	5	-	3x3	-
3	-	7	-	5x5
Lighting >1lx at floor level along the centre line without reflections Emax/Emin <40			Lighting >0.5lx at floor level without reflections Emax/Emin <40	
Performance with reference to luminaire Order Code 1499L 130 lm			Maintenance coefficient 0.8	

STILE IN 1499, 1499-24

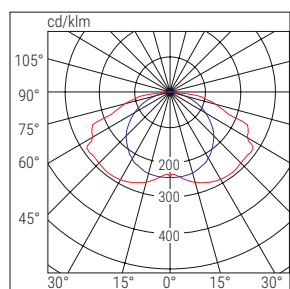

■ C90-C270 ■ C0-C180

STILE IN 1499L

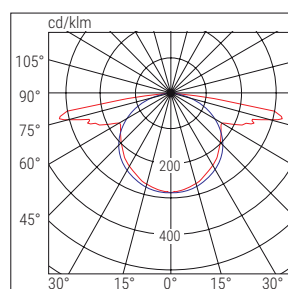

■ C90-C270 ■ C0-C180

	Order Code	W eq.	Description	Version	Autonomy h	Battery	FLUX SE lm	FLUX SA lm	Input power		Weight Kg	Packaging Single/Multi pack	Conform.
									DC	AC			
TR	1499	8	STILE IN LED 11 SE 8P	SE	8	Pb 4V 3Ah	130	-	2W		0.7	12	STANDARD
	1499/24	8	STILE IN LED 24 SE 6P	SE	6	Pb 4V 3Ah	200	-	2W		0.8	12	
	1499L	11	STILE IN LED 11 SE8 LI-FE	SE	8	LiFe 3.2V 3Ah	130	-	2W		0.4	12	

ACCESSORIES - included

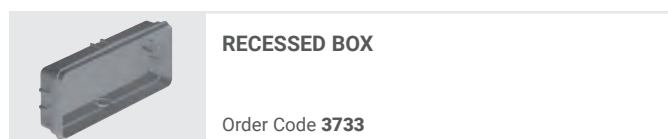

ACCESSORIES - to be ordered separately

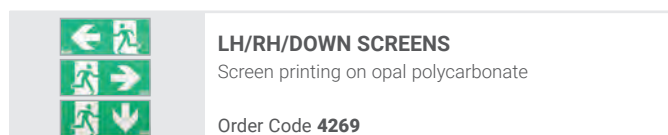
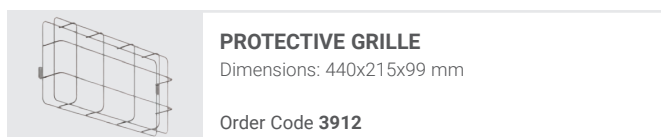
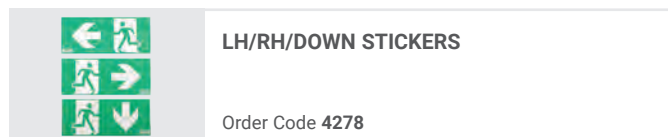
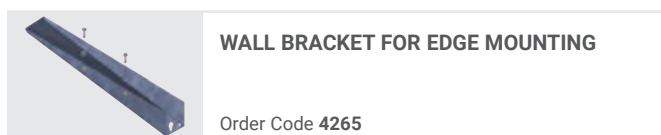
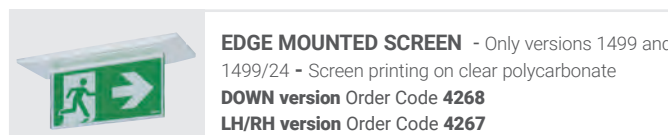

Metrica

emergency



IP65

IK07

850°



Batt. LTO

+45°C
-20°C



Luminous flux up to 1600lm and adjustable autonomy, with a fast-charging Titanium battery, with 10 years of service life and for extreme working temperatures.



Optics designed to direct the light beam towards the ground. An additional beam-controlled lens designed for escape routes is fitted as standard. When removing the lens, the beam width is ideal for overhead mounting.

Applications

Services, also for applications in design environments

Characteristics

Power supply* 230VAC ± 10%, 50÷60Hz

Mounting Wall, recessed

Recharging time 12h

Housing Polycarbonate, white RAL 9003

Optics Anti-glare aluminium

Screen Clear polycarbonate

Compliance EN 60598-1, EN 60598-2-2, EN 60598-2-22, UNI EN 1838, UNI 11222, EN 62034

* LG230, LG24, HT systems consider the parameters of the control unit used

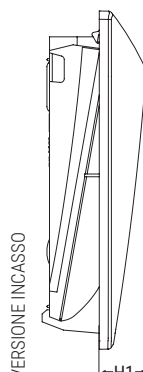
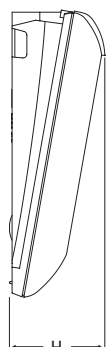
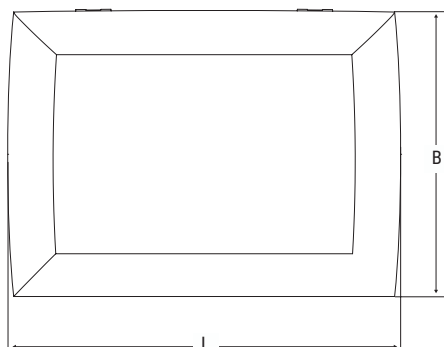

Version	Dimensions mm			
	L	B	H	H1
L	213	155	62	-
XL	355	180	58	-
L - recessed mounting kit	240	184	-	25
XL - recessed mounting kit	388	213	-	30

Reference standard UNI EN 1838

Lens	Height (m)	Centre distance (m) ESCAPE ROUTES		Illuminated surface area (m) LARGE AREAS	
		Wall	Ceiling	Wall	Ceiling
Present	2.5	16	-	-	-
Removed	2.5	-	-	7x10	-

Lighting >1lx at floor level along the centre line without reflections Emax/Emin <40

Lighting >0.5lx at floor level without reflections Emax/Emin <40

Performance with reference to luminaire Order Code 19421 800lm - Maintenance coefficient 0.8

METRICA WITH LENS

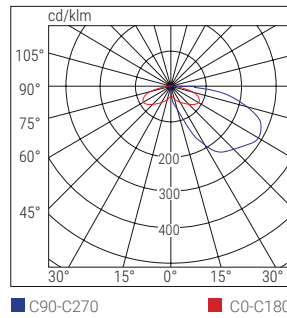

METRICA WITHOUT LENS

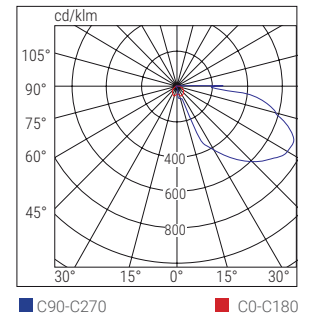

	Order Code	W eq.	Description	Version	Autonomy h	Battery	FLUX SE lm	Batt. AUTORIPARA SUPPLIED Flux SE lm	FLUX SA lm	Input power		Weight Kg	Packaging Single/ Multi pack
										DC	AC		
LG	19420	11	METRICA LED LGAR/ SA/PS LTO L	SA/SE/PS	1/1.5/3*	LTO 9.6V 0.5Ah	260	600/400/200	250	6.8W	8.6VA	0.8	1/12
	19421	36	METRICA LED LGAR/ SA/PS LTO XL	SA/SE/PS	1/1.5/3*	LTO 9.6V 1.2Ah	530	1600/1100/550	800	11.3W	12.6VA	1	1/12
	LGFM	Standalone luminaires with Centralised Radio Diagnostics integrating the Module Order Code 15037											
	DALI	Standalone luminaires with Dali Centralised Diagnostics integrating the Module Order Code 15038											
LG230	31121	11	METRICA LED LGS230 L				260		550	6.8W	8.6VA	0.7	1/12
	31123	36	METRICA LED LGS230 XL				530		1100	11.3W	12.6VA	0.8	1/6
LG24	32090	11	METRICA LED LGS24 L				260		550	3W	6.8VA	0.7	1/12
	32093	36	METRICA LED LGS24 XL				530		1100	4.3W	11.1VA	0.8	1/6
HT230	17423	11	METRICA LED HT L						550	6.3W	6.8VA	0.7	1/12
	17424	36	METRICA LED HT XL						1100	11W	11.1VA	0.8	1/6

* The indicated flux and autonomy refer to the luminaire set in HIGH FLUX mode - with the LONG OPERATING TIME setting, the autonomy doubles and the flux is reduced.

ACCESSORIES - included



AR LTO 9.6V 1.2Ah BATTERY SYSTEM
Compatible with Order Code 19421

Order Code **RA04**



CABLE CONDUIT GLAND PG16/PG20
Removable for overhead mounting

Order Code **3727**



AR LTO 9.6V 0.5Ah BATTERY SYSTEM
Compatible with Order Code 19420

Order Code **RA05**



LH/RH/DOWN STICKERS
XL version only

Order Code **12941**

ACCESSORIES - to be ordered separately



RECESSED MOUNTING KIT

Order Code **12942** (Version L)
Order Code **12943** (Version XL)



LGFM - DALI MODULE (LG version only)

LGFM - Order Code **15037**
DALI - Order Code **15038**

LGFM **DALI**



LG INIBIT REMOTE CONTROL
RM for LG versions only

Order Code **12101**

LG

Lungalargaluce

emergency



IP41

IK07

850°

Batt. LTO
+45°C
-20°C



Reduced aesthetic impact for a multi-purpose ceiling-mounted luminaire just 3 cm thick.



A single luminaire for evacuation routes up to more than 17m and for panic areas up to 130sqm. Ceiling mounting, but also wall mounting, thanks to the specific Diffusaluce lens. Adjustable autonomy from 1 to 8 hrs.



Three lenses supplied with different light beams. Optional asymmetrical accent lens for illuminating fire fighting and protective equipment.



Quick installation without any recessed holes.

Applications

Industry, services, warehouses, schools, hospitals, shops, shopping centres, offices

Characteristics

Power supply* 230VAC ± 10%, 50÷60Hz

Mounting Ceiling

Recharging time 12h

Housing Polycarbonate, white RAL 9010

Optics Highly transparent PMMA lenses

Compliance EN 60598-1, EN 60598-2-22, UNI EN 1838, UNI 11222, EN 62034

* LG230, LG24, HT systems consider the parameters of the control unit used

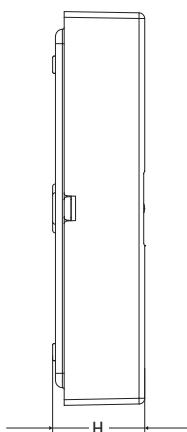
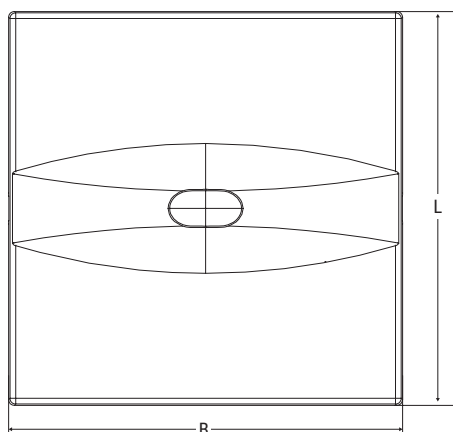

Dimensions mm

L	B	H
137	137	32

046

Reference standard UNI EN 1838

Lens	Height (m)	Centre distance (m) ESCAPE ROUTES		Illuminated surface area (m) LARGE AREAS	
		Wall	Ceiling	Wall	Ceiling
Lungaluce	3	-	20	-	-
Largaluce	3	-	-	-	12x12

Lighting >1lx at floor level along the centre line without reflections Emax/Emin <40

Lighting >0.5lx at floor level without reflections Emax/Emin <40

Performance with reference to luminaire Order Code 19329 450lm Maintenance coefficient 0.8



LUNGALUCE

87%

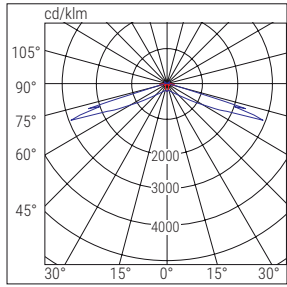

■ C90-C270 ■ C0-C180

LARGALUCE

95%

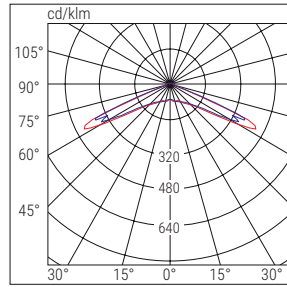

■ C90-C270 ■ C0-C180

DIFFUSALUCE

85%

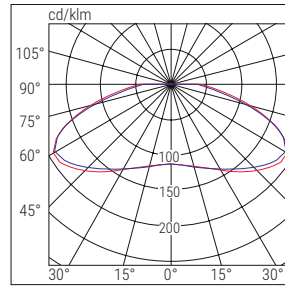

■ C90-C270 ■ C0-C180

	Order Code	W eq.	Description	Version	Autonomy h	Battery	FLUX SE lm	FLUX SA lm	Input power		Weight Kg	Packaging Single/ Multi pack	Conform.
									DC	AC			
AT - OPT	19328	24	L.LARG DWCL AT OPT 24W SA LTO	SA/SE	1/1.5/2/3/8	LTO 7.2V 0.5AH	250/200/150/80/50	220		5W		1/6	CENTRALISED SELF-TESTING
	19329	24GL	L.LARG DWCL AT OPT GL SA LTO	SA/SE	1/1.5/2/3/8	2x LTO 7.2V 0.5AH	450/330/250/160/170	220		5W		1/6	
	LG	Standalone luminaires with Centralised Diagnostics integrating the Module Order No. 15036											
	LGFM	Standalone luminaires with Centralised Radio Diagnostics integrating the Module Order Code 15037											
	DALI	Standalone luminaires with Dali Centralised Diagnostics integrating the Module Order Code 15038											
LG230	17876	24	LLARGA DWCL LGS230					380	4.1W	8.3VA		1/6	CENTRALISED BATTERY
LG24	17877	24	LLARGA DWCL LGS24 LS-UV				380	380	3.8W			1/6	
HT230	19320	24	L.LARG DWCL HT 24W					380	4.8W	9.6VA		1/6	

* The fluxes shown refer to the luminaire without lens. To identify the actual flux of the product, please consider the yield percentage indicated in the lens photometry in addition to the value shown in the table.

ACCESSORIES - included

	LUNGALUCE LENS
	LARGALUCE LENS
	DIFFUSALUCE LENS

ACCESSORIES - to be ordered separately

	LG - LGFM - DALI MODULE (AT-OPT version only) LG - Order Code 15036 LGFM - Order Code 15037 DALI - Order Code 15038
	LARGALUCE LENS 7m Order Code F95819
	LARGALUCE LENS 12m - Order Code F95808
	LUNGALUCE LENS 12m - Order Code F95807
	ASIMMETRICA* LENS - Order Code F95815

Lens photometry and fluxes are available in the electronic catalogue on begelli.com.

Lungalargaluce-recessed mounting

emergency



 Recessed luminaire with multi-purpose beam and very low aesthetic impact.

 A single luminaire for escape routes up to more than 17m and for panic areas up to 130sqm. Adjustable autonomy from 1 to 8 hrs.

 Two lenses supplied. Optional asymmetrical accent lens for illuminating fire fighting and protective equipment.

 Extremely quick mounting thanks to steel springs that allow orientation even after installation. Recessed hole \varnothing 80±100mm.

Applications

Services, offices, cinemas, hotels, museums, schools, shops, shopping centres, design rooms

Characteristics

Power supply* 230VAC \pm 10%, 50÷60Hz

Mounting False ceiling, recessed

Recharging time 12h

Housing Polycarbonate, white RAL 9010

Optics Highly transparent PMMA lenses

Compliance EN 60598-1, EN 60598-2-2, EN 60598-2-22, UNI EN 1838, UNI 11222, EN 62034

* LG230, LG24, HT systems consider the parameters of the control unit used

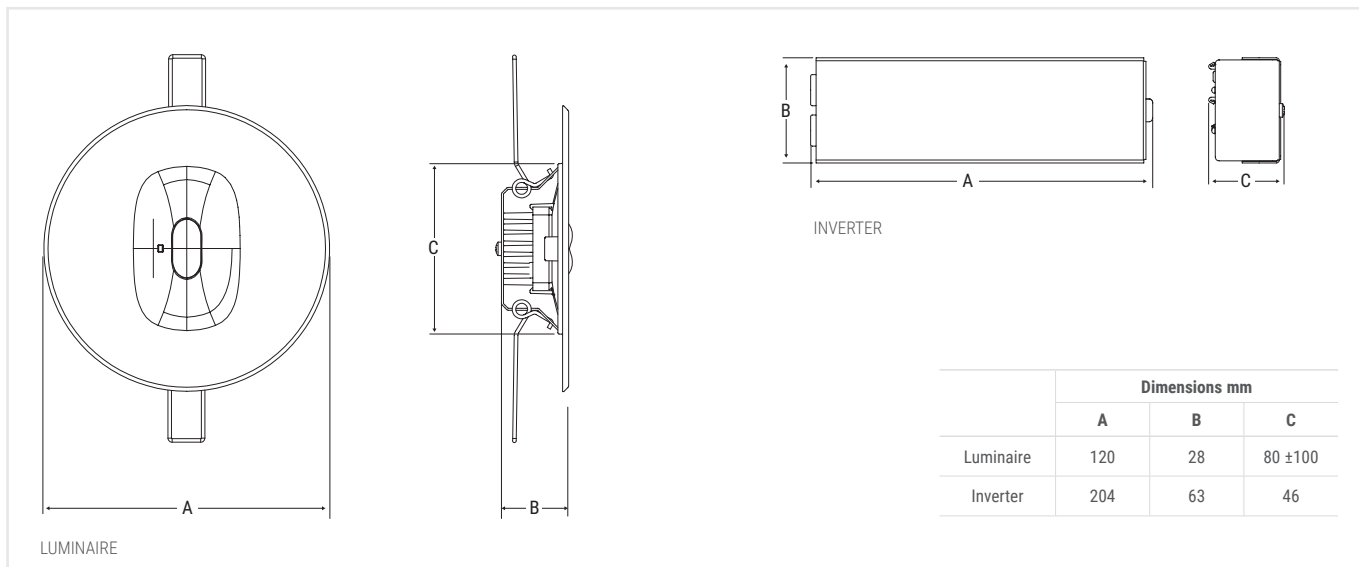

Reference standard UNI EN 1838

Lens	Height (m)	Centre distance (m) ESCAPE ROUTES		Illuminated surface area (m) LARGE AREAS	
		Wall	Ceiling	Wall	Ceiling
Lungaluce	3	-	20	-	-
Largaluce	3	-	-	-	12x12
Lighting >1lx at floor level along the centre line without reflections Emax/Emin <40				Lighting >0.5lx at floor level without reflections Emax/Emin <40	
Performance with reference to luminaire Order Code 19339 450lm				Maintenance coefficient 0.8	



LUNGALUCE

87%

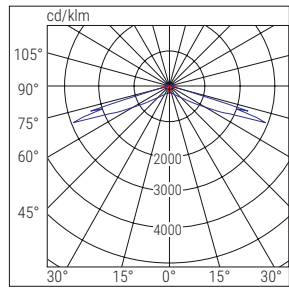

■ C90-C270 ■ C0-C180

LARGALUCE

95%

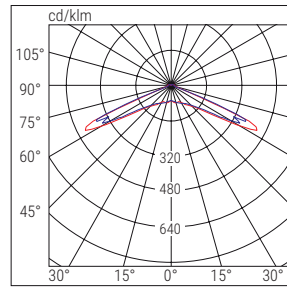

■ C90-C270 ■ C0-C180

	Order Code	W eq.	Description	Version	Autonomy h	Battery	FLUX SE lm	FLUX SA lm	Input power		Weight Kg	Packaging Single/ Multi pack	Conform.
									DC	AC			
AT - OPT	19338	24	LLARG DWRC AT/OPT 24W SA LTO	SA/SE	1/1.5/2/3/8	LTO 7.2V 0.5AH	250/200/150/80/50	220	5W		1/6		CENTRALISED SELF-TESTING
	19339	24GL	LLARG DWRC AT/OPT 24W GL SA LTO	SA/SE	1/1.5/2/3/8	2x LTO 7.2V 0.5AH	450/330/250/160/70	220	5W		1/6		
	LG	Standalone luminaires with Centralised Diagnostics integrating the Module Order No. 15036											
	LGFM	Standalone luminaires with Centralised Radio Diagnostics integrating the Module Order Code 15037											
	DALI	Standalone luminaires with Dali Centralised Diagnostics integrating the Module Order Code 15038											
LG230	17878	24	L.LARGA DWRC LGS230					380	4.1W	8.3VA		1/6	CENTRALISED BATTERY
LG24	17879	24	L.LARGA DWRC LGS24 LS-UV				380	380	3.8W			1/6	
HT230	19330	24	L.LARG DWRC HT 24W					380	4.8W	9.6VA		1/6	

* The fluxes shown refer to the luminaire without lens. To identify the actual flux of the product, please consider the yield percentage indicated in the lens photometry in addition to the value shown in the table.

ACCESSORIES - included



ACCESSORIES - to be ordered separately

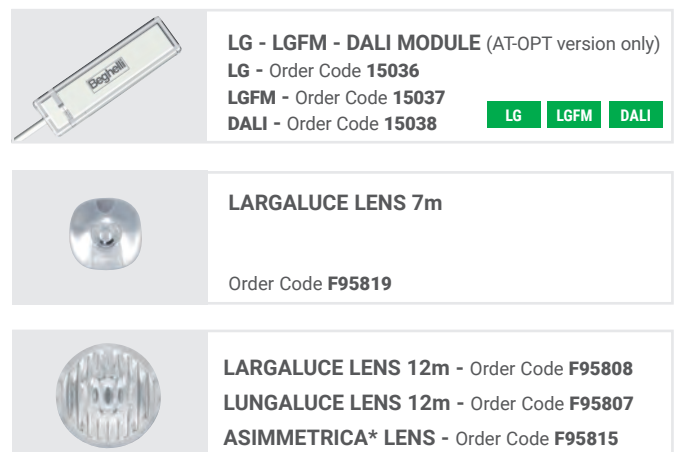



Lens photometry and fluxes are available in the electronic catalogue on begelli.com.

Multi Lens

emergency



 Minimal aesthetic impact and high performance with a 10-year warranty.

 A single luminaire for escape routes up to 12m and for panic areas up to 90sqm. Adjustable autonomy from 1 to 8 hrs.

 Three interchangeable lenses supplied for mounting from 3 to 7m high, with different light beams.

 Springs for quick fastening to false ceilings.
Recessed hole \varnothing 60 mm.

Applications

Services, offices, cinemas, hotels, schools, shops, shopping centres, showrooms

Characteristics

Power supply 230VAC \pm 10%, 50÷60Hz

Mounting Recessed

Recharging time 12h

Housing Polycarbonate

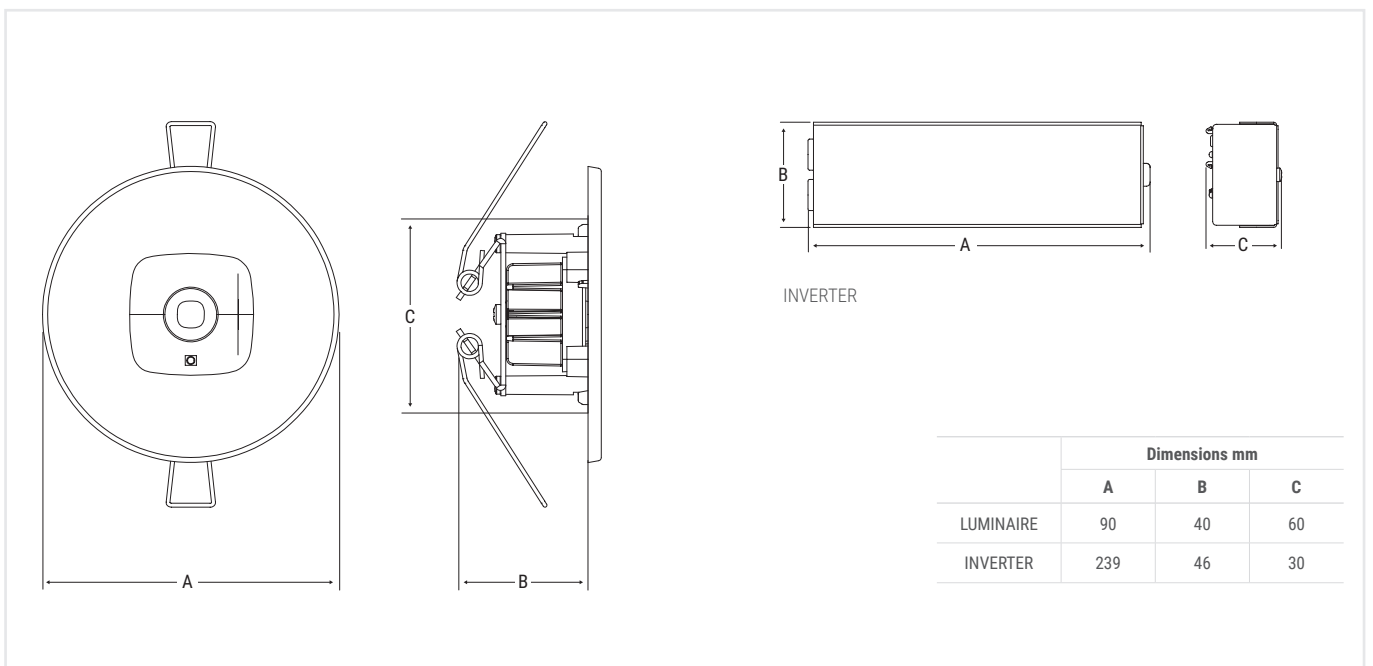

Optics Highly transparent PMMA lenses

Compliance EN 60598-1, EN 60598-2-2, EN 60598-2-22, UNI EN 1838, UNI 11222, EN 62034



	Dimensions mm		
	A	B	C
LUMINAIRE	90	40	60
INVERTER	239	46	30

Reference standard UNI EN 1838

Lens	Height (m) 	Centre distance (m) ESCAPE ROUTES 		Illuminated surface area (m) LARGE AREAS 		
		Wall	Ceiling	Wall	Ceiling	
Lungaluce	3	-	17	-	-	
Largaluce	3	-	-	-	12x12	
Altaluce	7	-	15	-	-	
			Lighting >1lx at floor level along the centre line without reflections Emax/Emin <40		Lighting >0.5lx at floor level without reflections Emax/Emin <40	
Performance with reference to luminaire Order Code 4334 450lm				Maintenance coefficient 0.8		

LUNGALUCE

87%

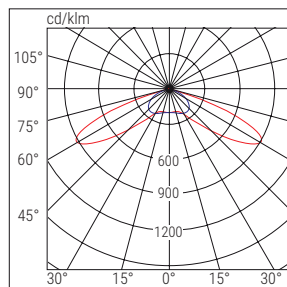

■ C90-C270 ■ C0-C180

LARGALUCE

92%

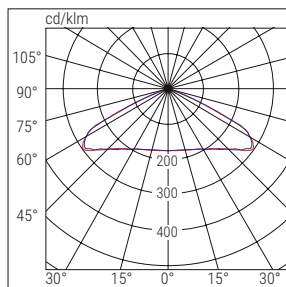

■ C90-C270 ■ C0-C180

ALTALUCE

85%

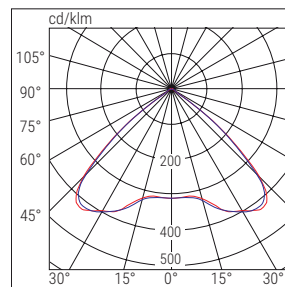

■ C90-C270 ■ C0-C180

	Order Code	W eq.	Description	Version	Autonomy h	Battery	FLUX SE lm	FLUX SA lm	Input power		Weight Kg	Packaging Single/ Multi pack
									DC	AC		
TR	4330	24	MULTI LENS 60MM SE 1h RM	SE	1	LiFe 3.2V 1.5Ah	250			1W	0.4	1/6
	4331	11	MULTI LENS 60MM SE 3h RM	SE	3	LiFe 3.2V 1.5Ah	90			1.5W	0.4	1/6
	4334	24GL	MULTI LENS GL 60MM SA 1/2/3h RM	SA/SE	1/2/3	LiFe 3.2V 1.5Ah	450/250/150	220		3W	0.4	1/6
	4335	24GL	MULTI LENS GL 60MM SA 2/3/6h RM	SA/SE	2/3/6	LiFe 3.2V 3Ah	450/300/150	220		3W	0.4	1/6
AT - OPT	4390	24	MULTI LENS AT OPT SE 8LTO	SE	1/1.5/2/3/8	LTO 7.2V 0.5AH	250/200/150/80/50			3.5W	0.4	1/6
	4391	24	MULTI LENS AT OPT SA 8LTO	SA/SE	1/1.5/2/3/8	LTO 7.2V 0.5AH	250/200/150/80/50	220		5W	0.4	1/6
	4393	24GL	MULTI LENS GL AT OPT SA 8LTO	SA/SE	1/1.5/2/3/8	2xLTO 7.2V 0.5AH	450/330/250/160/170	220		5W	0.4	1/6
	LG	Standalone luminaires with Centralised Diagnostics integrating the Module Order No. 15036										
LGFM	Standalone luminaires with Centralised Radio Diagnostics integrating the Module Order Code 15037											
DALI	Standalone luminaires with Dali Centralised Diagnostics integrating the Module Order Code 15038											

ACCESSORIES - included

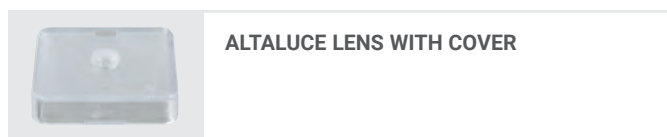
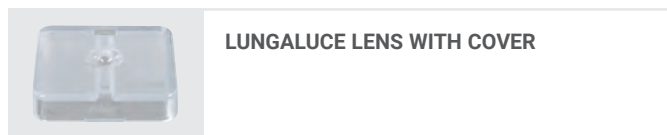

ACCESSORIES - to be ordered separately

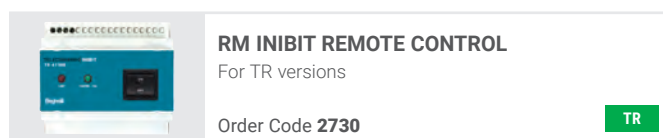
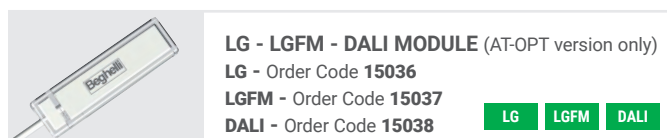

Lumax 65

emergency



Titanium battery for fast charging and a long luminaire lifespan. High luminous flux with diffuse emission



Lighting and emergency lighting integrated with multiple control systems, both self-contained and centralised



Available version with microwave motion sensor for automatic lighting activation

Applications

Indoor, outdoor, services, residential buildings, stairwell lighting, corridors, shops, hotels, restaurants

Characteristics

Power supply* 230VAC \pm 10%, 50÷60Hz

Mounting Wall, ceiling

Recharging time 12h

Housing Polycarbonate, grey RAL 9006

Screen Opal polycarbonate

Compliance EN 60598-1, EN 60598-2-22, UNI EN 1838, UNI 11222, EN 62034

* LG230, LG24, HT systems consider the parameters of the control unit used

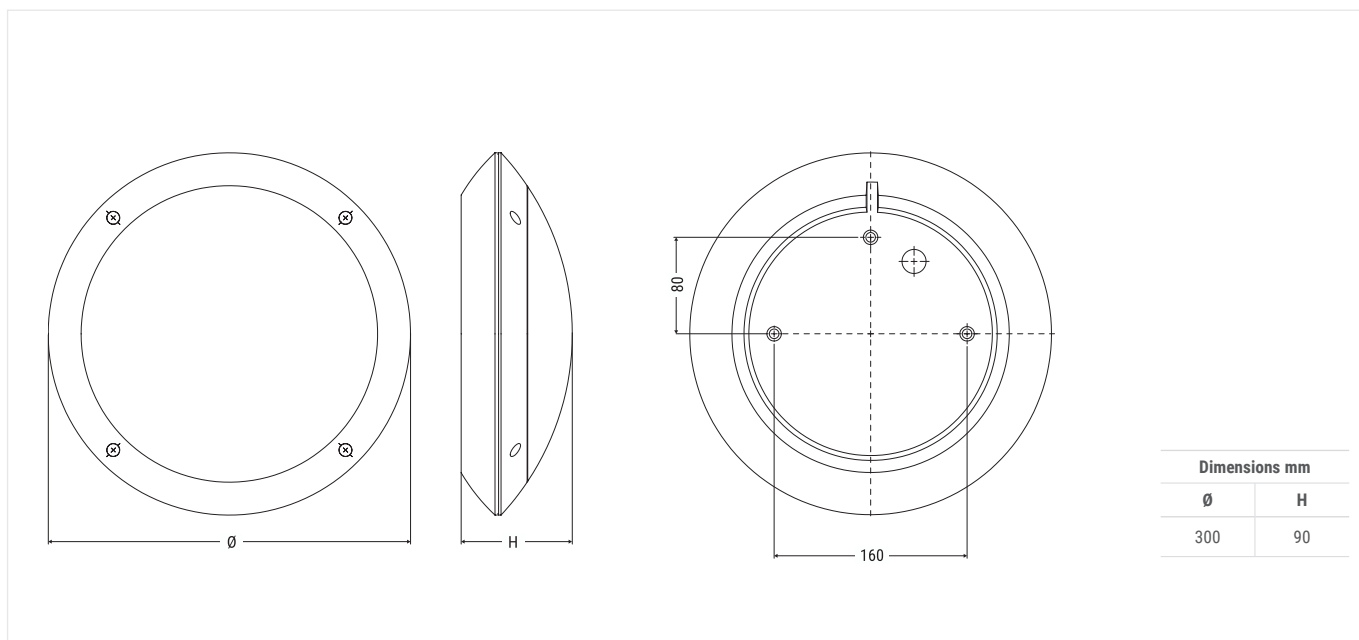

Dimensions mm	
Ø	H
300	90

052

Performance according to EN 1838

Height (m)	Centre distance (m) ESCAPE ROUTES		Illuminated surface area (m) LARGE AREAS	
	Wall	Ceiling	Wall	Ceiling
2.5	6	-	6x6	-
3	-	10	-	6x6
Lighting >1lx at floor level along the centre line without reflections Emax/Emin <40			Lighting >0.5lx at floor level without reflections Emax/Emin <40	
Performance with reference to luminaire Order Code 37126 278 lm			Maintenance coefficient 0.8	

LUMAX 65

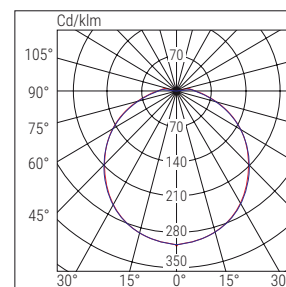

■ C0-C180

■ C90-C270

	Order Code	W eq.	Description	Version	Autonomy h	Battery	FLUX SE lm	FLUX SA lm	Input power		Weight Kg	Packaging Single/Multi pack
									DC	AC (SE/SA)		
AT	37126		LUMAX65 GR SA/SE AT 4K	SA/SE	1/3/8	2 x LTO 7.2V 0.5Ah	278/140/38	1500		2.5/18W		AUTOTEST
	37236*		LUMAX65 GR SA/SE AT 4K MW	SA/SE	1/3/8	2 x LTO 7.2V 0.5Ah	278/140/38	1500		2.5/18W		
LG	37127		LUMAX65 GR SA/SE LG 4K	SA/SE	1/3/8	2 x LTO 7.2V 0.5Ah	278/140/38	1500		2.5/18W		CENTRALTEST
	37237*		LUMAX65 GR SA/SE LG 4K MW	SA/SE	1/3/8	2 x LTO 7.2V 0.5Ah	278/140/38	1500		2.5/18W		
LGFM	37128		LUMAX65 GR SA/SE LGFM 4K	SA/SE	1/3/8	2 x LTO 7.2V 0.5Ah	278/140/38	1500		2.5/18W		CENTRALTEST
	37238*		LUMAX65 GR SA/SE LGFM 4K MW	SA/SE	1/3/8	2 x LTO 7.2V 0.5Ah	278/140/38	1500		2.5/18W		
LG230	31090		LUMAX65 GR S230 SA/SE 4K	SA/SE				1500	18.5W	19.5VA		CENTRALISED BATTERY
	31208		LUMAX65 GR S230 SA/SE 4K MW	SA/SE				1500	18.5W	19.5VA		
LG24	32067		LUMAX65 GR S24 SA/SE 4K	SA/SE			280	1500	4.3W	18VA		CENTRALISED BATTERY
	32122*		LUMAX65 GR S24 SA/SE 4K MW	SA/SE			280	1500	4.3W	18VA		
HT230	31092		LUMAX65 GR HT 4K					1500	17W	18VA		CENTRALISED BATTERY
	31210*		LUMAX65 GR HT 4K MW					1500	17W	18VA		

* Version with built-in microwave motion sensor

ACCESSORIES - to be ordered separately



LG INIBIT REMOTE CONTROL
RM for LG versions only

Order Code **12101**

LG



TuttiFrutti

emergency



IP40

IK05

850°



Batt. LiFe

+40°C
0°C

Batt. NiCd

+40°C
0°C



Advanced emergency system for all popular emergency luminaires for wiring systems.



Light sensor for automatic activation in night mode.



Triple reflective system for lighting, status LED display and activation of the light sensor in protected mode from other artificial sources.



Patented fixing system that fits all emergency luminaires for wiring systems. Mounting does not require a replacement of the existing frame and/or plate. Anchoring is done directly on the holes of the wall recess-mounted box (503/506) only.

Applications

Residential and services, either emergency lighting or night lighting, as well as steplight

Characteristics

Power supply 230VAC \pm 10%, 50÷60Hz

Mounting recessed (box 506)

Recharging time 12h with LiFe battery

Housing Polycarbonate

Optics PC, asymmetrical, metallic

Screen Clear polycarbonate

Compliance EN 60598-1, EN 60598-2-2, EN 60598-2-22, UNI EN 1838, UNI 11222, EN 62034

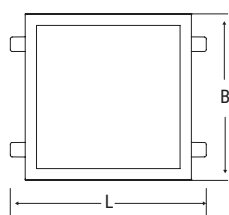

TUTTI FRUTTI 2

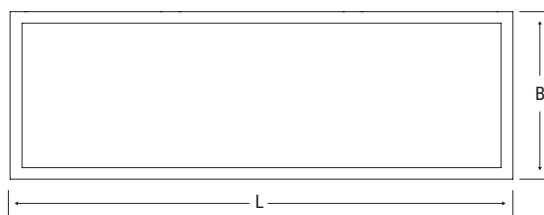

TUTTI FRUTTI 6

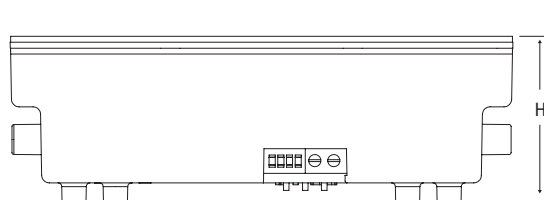
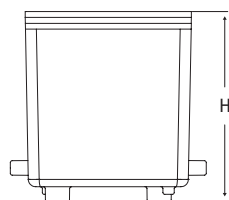

Version	Dimensions mm		
	L	B	H
TUTTI FRUTTI 2	52	44	54
TUTTI FRUTTI 6	132	44	44

TUTTIFRUTTI 2

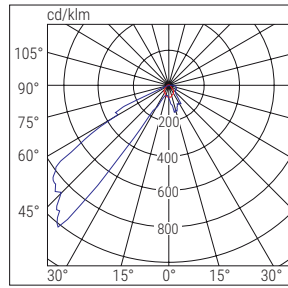
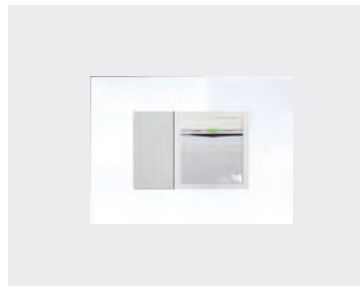

■ C90-C270 ■ C0-C180

TUTTIFRUTTI 6

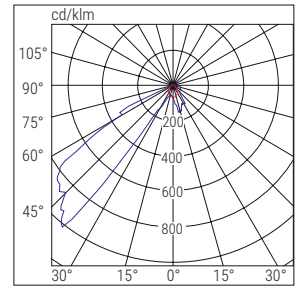

■ C90-C270 ■ C0-C180

	Order Code	Description	Version	Autonomy h	Battery	FLUX SE lm	FLUX SA lm	Input power		Weight Kg	Packaging Single/Multi pack
								DC	AC		
TR	TUTTIFRUTTI 2										
	4607	TUTTIFRUTTI 2-3 LED SE 2h	SE	2	LiFe 3.2V 0.2Ah	30			0.7W	0.25	1/6
TR	TUTTIFRUTTI 6										
	4609	TUTTIFRUTTI 6 LED SE 2h	SE	2	NiCd 3.6V 0.4Ah	70	-		0.7W	0.25	1/24



055 emergency luminaires for wiring systems

Fruttoluce

emergency

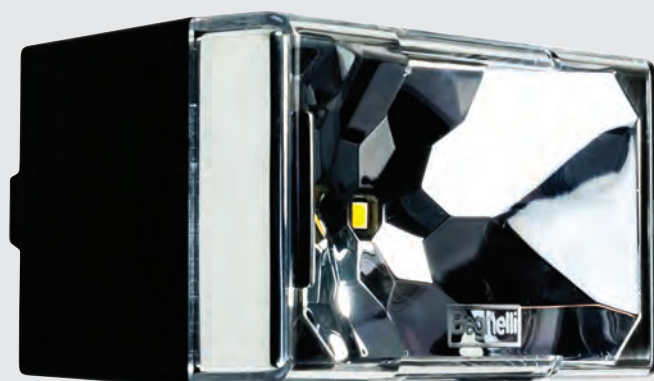

Residential emergency system with modules of 1, 2, 3 and 6 electrical contact blocks.



Light sensor for automatic activation in night mode. 3 x electrical contact blocks pull-out version.



Triple reflective system for lighting, status LED display and activation of the light sensor in protected mode from other artificial sources.



Each luminaire is equipped with adapters for mounting on the most common emergency luminaires for wiring systems.

Applications

Services and residential, for emergency lighting or night lighting and as steplight

Characteristics

Power supply 230VAC \pm 10%, 50-60Hz

Mounting Wall as steplight, wall as night light, wall as emergency lighting

Housing Polycarbonate

Optics Asymmetrical, metallic

Screen Clear polycarbonate

Compliance EN 60598-1, EN 60598-2-2, EN 60598-2-22, UNI EN 1838, UNI 11222, EN 62034

IP40

IK05

850°



Batt. NiCd
+40°C
0°C

Batt. Li-ion
+40°C
0°C

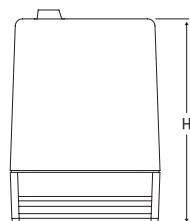
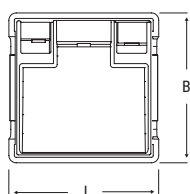

FRUTTOLUCE 1-2

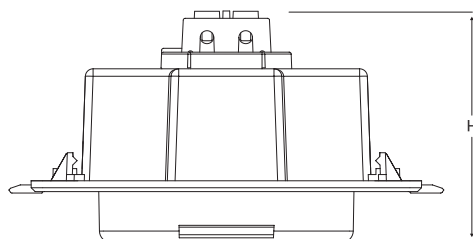
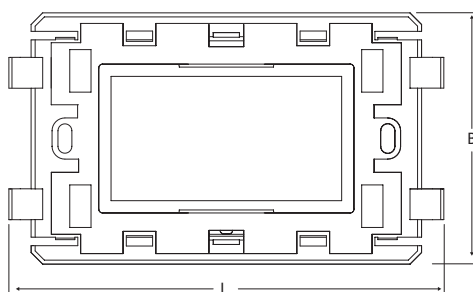

FRUTTOLUCE 3-6

Version	Dimensions mm		
	L	B	H
FRUTTOLUCE 1	19	41	56.5
FRUTTOLUCE 2	41	41	56.5
FRUTTOLUCE 3	112	65	60
FRUTTOLUCE 6	187	70	40

FRUTTOLUCE 1

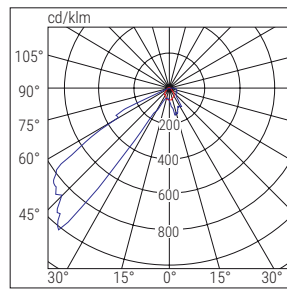
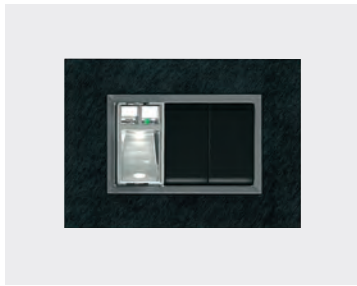

■ C90-C270 ■ C0-C180

FRUTTOLUCE 2

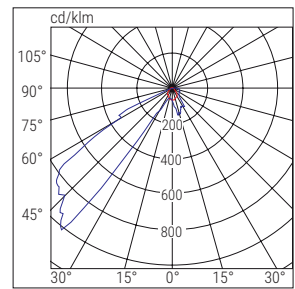
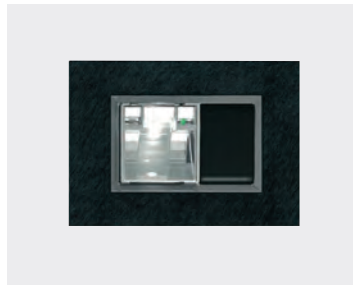

■ C90-C270 ■ C0-C180

FRUTTOLUCE 3

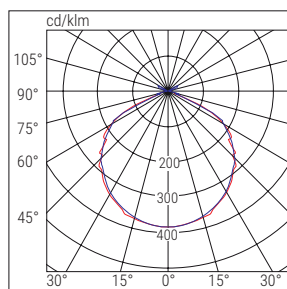
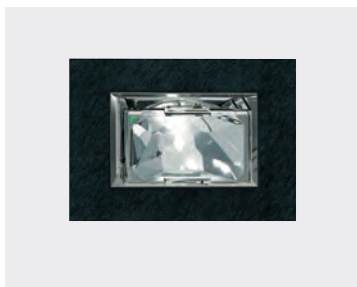

■ C0-C180 ■ C90-C270

FRUTTOLUCE 6

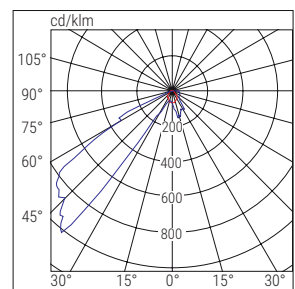

■ C90-C270 ■ C0-C180

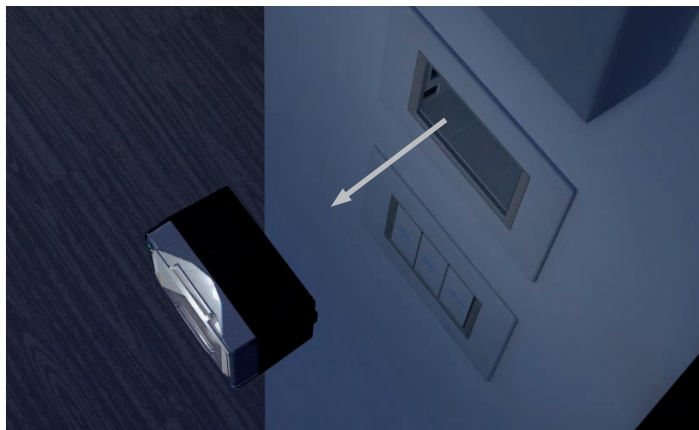

FRUTTOLUCE 3

EXTRACTABLE TORCH FOR DOMESTIC USE

FruttoLuce3 can be conveniently removed from the mount to bring light where it is needed. The unlocking system facilitates the extraction of the torch while ensuring a maximum safety of the power supply terminal block.

	Order Code	Description	Version	Autonomy h	Battery	FLUX SE lm	FLUX SA lm	Input power		Weight Kg	Packaging Single/ Multi pack	
								DC	AC			
TR	FRUTTOLUCE 1											
	4601	FRUTTOLUCE1 LED SE/SA 1N	SA/SE	1	Li-ion 3.2V 0.1Ah				0.5W	0.1	12	
	FRUTTOLUCE 2											
	4602	FRUTTOLUCE2 LED SE/SA 1N	SA/SE	1	NiCd 2.4V 0.4Ah				0.8W	0.13	12	
FRUTTOLUCE 3												
	4603	FRUTTOLUCE3 LED SE/SA 1N	SA/SE	1	NiCd 2.4V 0.4Ah				0.4W	0.2	12	
FRUTTOLUCE 6												
	4605	FRUTTOLUCE6 LED 4605-SE/SA 1N	SA/SE	1	NiCd 4.8V 0.4Ah				1W	0.2	12	

STANDARD

Linea 500

emergency



IP40

IK05

850°



Batt. NiCd

+40°C
0°C



Residential emergency for boxes 503 and 506, hole cover plate supplied.



Also suitable for use as a steplight in public places of entertainment.

Applications

Residential and services, also in premises used for public entertainment

Characteristics

Power supply 230VAC \pm 10%, 50÷60Hz

Mounting Recessed

Housing Polycarbonate

Optics Symmetrical, metallic

Screen Clear polycarbonate

Plate Polycarbonate, RAL 9003

Compliance EN 60598-1, EN 60598-2-2, EN 60598-2-22, UNI EN 1838, UNI 11222, EN 62034

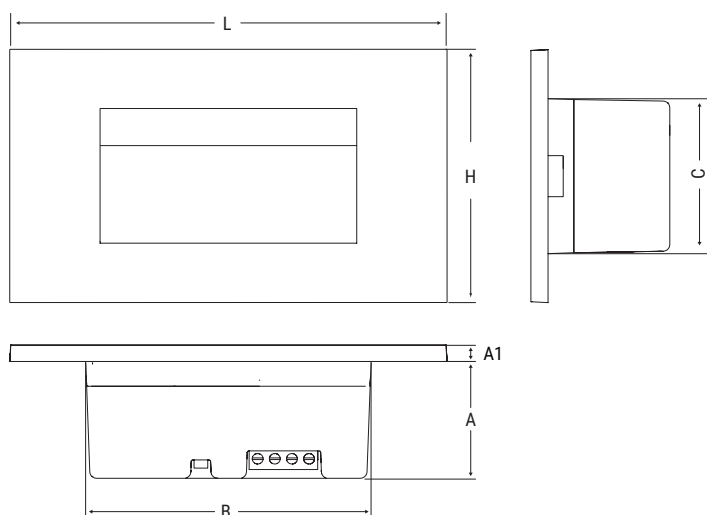

Version	Dimensions mm					
	L	H	B	A	A1	C
LINEA 503	118	76	78	36	5	49
LINEA 506	209	76	164	35	5	47

058

LINEA 503

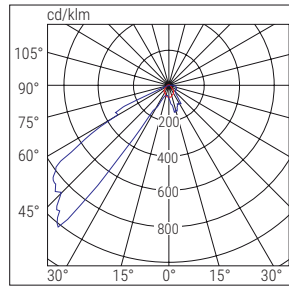
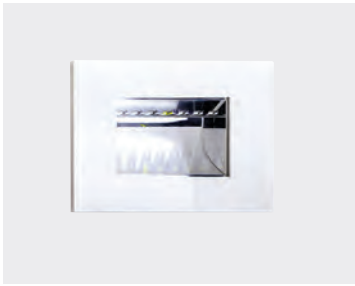

■ C90-C270 ■ C0-C180

LINEA506

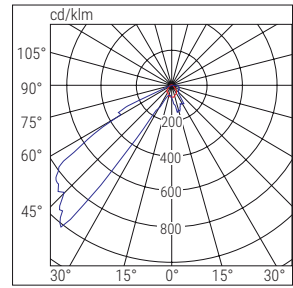

■ C90-C270 ■ C0-C180

	Order Code	Description	Version	Autonomy h	Battery	FLUX SE lm	FLUX SA lm	Input power		Weight Kg	Packaging Single/Multi pack
								DC	AC		
TR	LINEA 503										
	4611	LINEA 503 LED SE 2h	SE	2	NiCd 3.6V 0.4Ah	60			0.8W	0.4	1/12
TR	LINEA 506										
	4612	LINEA 506 LED SE 1h	SE	1	NiCd 3.6V 0.4Ah	40			0.8W	0.4	1/12

STANDARD

ACCESSORIES - included

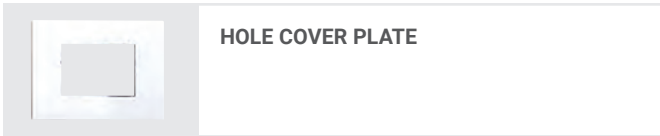

059 emergency luminaires for wiring systems

Placca Brain Classic Emergenza

emergency



IP20
IK05
850°
□
Batt. Li-ion
+40°C
0°C
15 RGB settable colours



Light plate with 15 colours that can be adjusted to different levels of light intensity. Equipped with battery for emergency lighting.



Steplight, night lighting, emergency lighting function.



Double battery of high intensity RGB LEDs with lighting scheme and light diffusion pattern, backlight type.



It can be installed on all the most common emergency luminaires for wiring systems using the existing electrical contact blocks and frame. White and black versions.

Applications

Residential, services, luxury hotels, showrooms, designer restaurants

Characteristics

Power supply* 230VAC ± 10%, 50÷60Hz

Mounting On box 503

Housing Polycarbonate, white RAL 9003

Diffuser PMMA

Compliance EN 60598-1, EN 60598-2-22

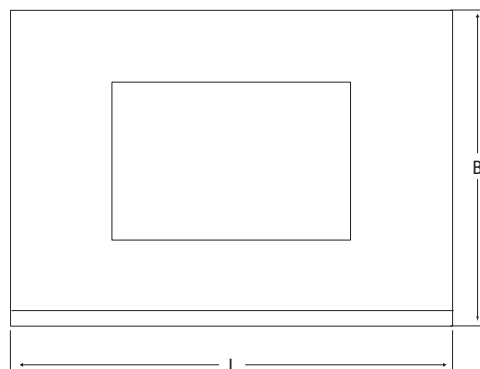

PLATE FOR BOX 503



BATTERY FOR EMERGENCY LIGHTING

	Dimensions mm		
	L	B	H
PLATE	126	90	12
BATTERY	45	9	6

060

NIGHT LIGHT

Light sensor with selectable colour and intensity modes, differentiated for day and night.

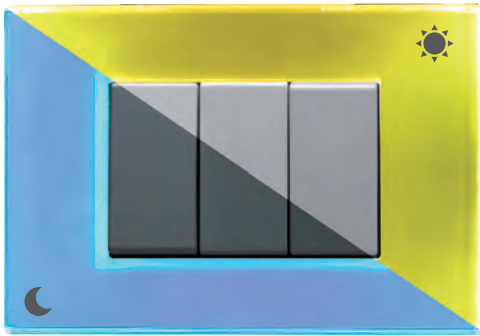

COMPATIBILITY WITH THE MOST POPULAR EMERGENCY LUMINARIES FOR WIRING SYSTEMS

BTicino Axolute - BTicino Axolute AIR - BTicino Light - BTicino Living Light - BTicino Living Light AIR - BTicino Living International - Vimar Plana - Vimar Arkè Vimar Eikon - Vimar Eikon EVO - Gewiss Chorus - AVE Sistema 44 - ABB Chiara - ABB Mylos.

The trademarks mentioned in the table are registered trademarks of their respective owners. The luminaire series mentioned, with which the "BRAIN" plates are mechanically compatible, have their own original plates.

	Order Code	Description	Version	Autonomy h	Battery	FLUX SE lm	FLUX SA lm	Input power		Weight Kg	Packaging Single/ Multi pack
								DC	AC		
TR	81143	BRAIN CLASSIC EM 3F PLATE, WHITE	SA/SE	1	Li-ion 3.7V 0.5Ah				1.5W	0.1	1/12
	81144	BRAIN CLASSIC EM 3F PLATE, BLACK	SA/SE	1	Li-ion 3.7V 0.5Ah				1.5W	0.1	1/12

ACCESSORIES - included



CLASSIC BATTERY

Order Code **81296E**

TR



ADAPTER SERIES

For mounting in all common emergency luminaires for wiring systems

ACCESSORIES - to be ordered separately



SPECIAL ADAPTERS

For BTicino Matix series, Living 1st series, Vimar Idea

Order Code **81236** (white)

Order Code **81237** (black)



Acciaio emergenza

emergency



IP66

IK09

850°

Batt. LiFe
+40°C
0°C

Batt. NiMH
+40°C
0°C

Batt. ICE PACK
+40°C
-40°C



Luminaire characterised by high mechanical and chemical resistance and a luminous flux of up to 1800lm.



Reflector with 4 separate anti-glare cells and micro-prismatic glass screen with high light transmission.



Easy installation with steel hooks, quick access to the wiring system.

Applications

Industrial, high-risk areas including explosive atmospheres, outdoors

Characteristics

Power supply* 230VAC ± 10%, 50÷60Hz

Mounting Wall, ceiling, suspended, electrified track

Recharging time 12h with LiFe battery

Housing Pre-galvanised sheet steel, powder-coated RAL 7035

Heads Technopolymer PC+PBT

Optics Diffusing, anti-glare aluminium

Screen High-transmission micro-prismatic tempered glass (3mm)

Compliance EN 60598-1, EN 60598-2-22, EN 1838, UNI 11222, ATEX 2014/34/EU (classification: II 3 G Ex nA II B T135, II 3 D Ex tD A22 T85)

* LG230, LG24, HT systems consider the parameters of the control unit used

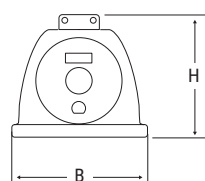
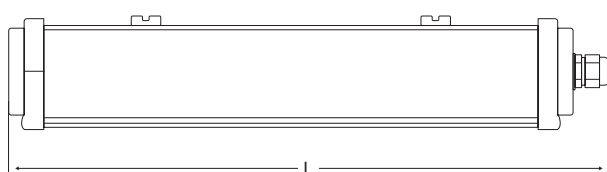

Dimensions mm

L	B	H
464	108	98.5

Performance according to EN 1838

Height (m)	Centre distance (m) ESCAPE ROUTES		Illuminated surface area (m) LARGE AREAS	
	Wall	Ceiling	Wall	Ceiling
3	-	10	-	8x8
7	-	15	-	14x14
Lighting >1lx at floor level along the centre line without reflections Emax/Emin <40			Lighting >0.5lx at floor level without reflections Emax/Emin <40	
Performance with reference to luminaire Order Code 15030 400 lm			Maintenance coefficient 0.8	

EMERGENCY STEEL

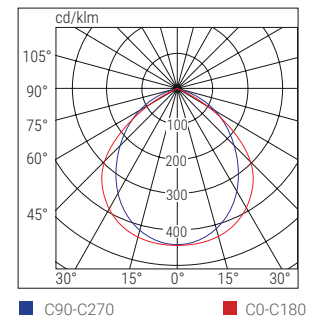

LOW TEMPERATURE INSTALLATION WITH ICE PACK - only for Order Code 15030



Accessory to keep the battery warm even when operating in very low temperatures (down to -40°C). Ice Pack is controlled by an electronic circuit that maintains a constant battery temperature.

	Order Code	W eq.	Description	Version	Autonomy h	Battery	FLUX SE lm	FLUX SA lm	Input power		Weight Kg	Packaging Single/Multi pack	Conform.
									DC	AC			
LG	15030	24	ACC EM LED 24 LG SE/SA 123H	SA/SE	1/2/3	NiMh 7.2V 1.2Ah	400/275/200	220		4W	1.6	1	CENTRALTEST
	15032	24	ACC EM LED 24 LG SE GL	SE	0.75/1/2/3/8	LiFe 12.8V 1.5A	1800/1500/800/500/200		4W	1.6	1		
	LGMF Standalone luminaires with Centralised Radio Diagnostics integrating the Module Order Code 19375												
LG230	31053	24	STEEL LED SE/SA LGS230 GL	SA/SE				1800	14.8W	19.6VA	1.5	1	CENTRALISED BATTERY
	31054	24	STEEL LED SE/SA LGS230	SA/SE				510	4.7W	9.4VA	1.5	1	
LG24	32055	24	STEEL LED SA LGS24	SA/SE			510	510	4.3W		1.5	1	CENTRALISED BATTERY
	32092	24	STEEL LED SE LGS24 GL	SE			900/1800		8/16W		1.5	1	
HT230	17452	24	STEEL AND LED HT GL	SA/SE				1800	14.2W	17.4VA	1.5	1	

* The indicated battery life doubles with the Autoripara battery, if the luminaire is set to LONG OPERATING TIME

ACCESSORIES - included

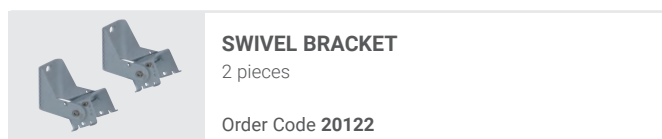

ACCESSORIES - to be ordered separately

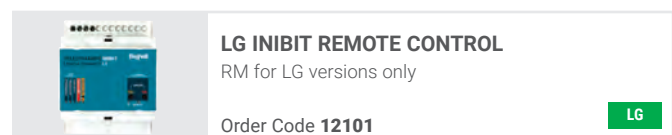
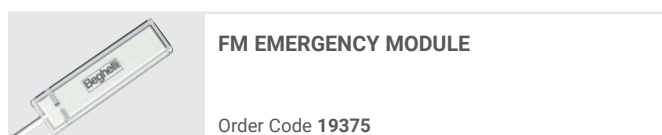
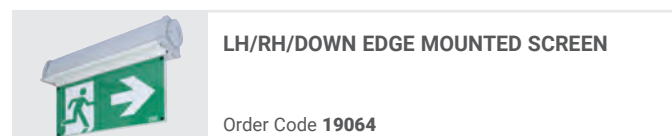
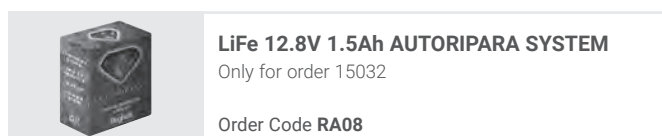
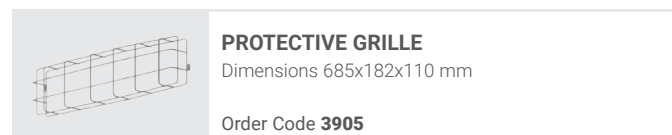
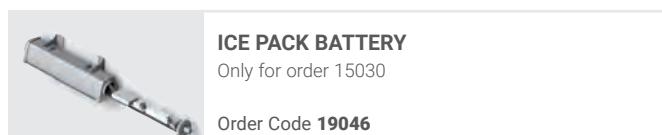

Lungalargaluce Extreme

emergency



Luminous flux up to 3200lm, suitable for high risk environments where Atex compliance is required. Fast-charging Titanium battery, with 10 years of service life and for extreme working temperatures.



A single luminaire for lighting large areas, escape routes and halls from 2m to over 7m high.



Five easily interchangeable lenses supplied.



Ready for through-wiring.

Applications

Industrial, in high-risk environments with dust and explosive substances.

Characteristics

Power supply* 230VAC \pm 10%, 50÷60Hz

Mounting Wall, ceiling, recessed

Recharging time 12h

Housing Die-cast aluminium, RAL 7040

Optics Clear polycarbonate lenses

Compliance EN 60598-1, EN 60598-2-2, EN 60598-2-22, EN 1838, UNI 11222, ATEX 2014/34/EU (classification: II 3 G Ex nA II B T135, II 3 D Ex tD A22 T85

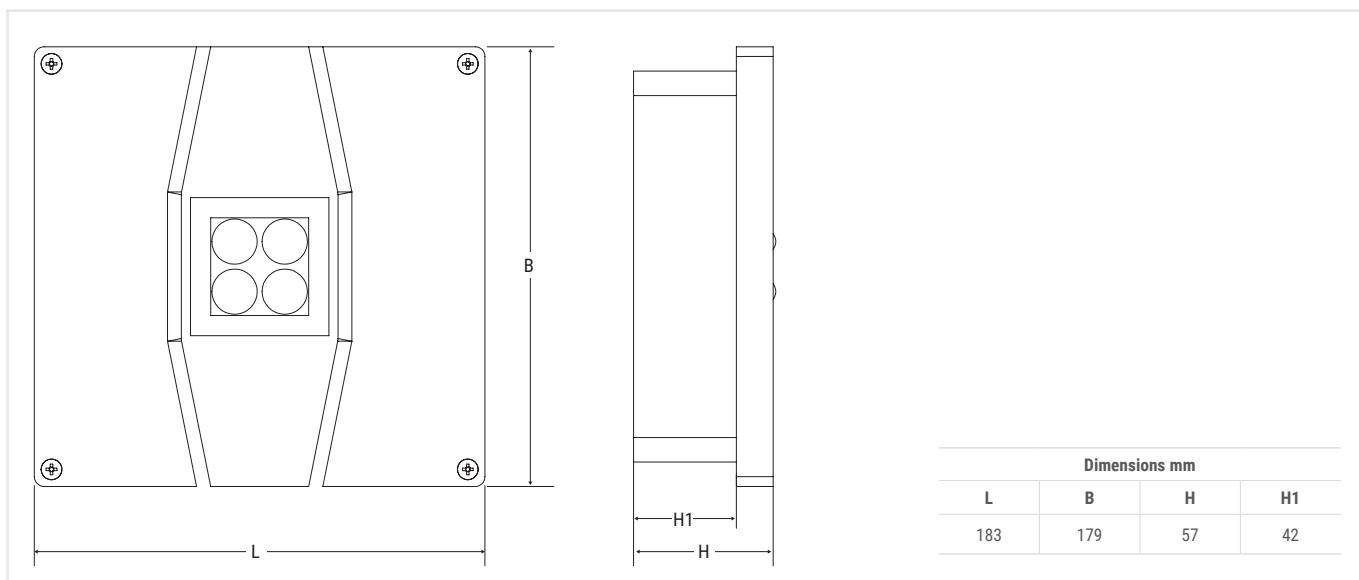

* LG230, LG24, HT systems consider the parameters of the control unit used



Dimensions mm			
L	B	H	H1
183	179	57	42

064

Reference standard UNI EN 1838

Lens	Height (m) 	Centre distance (m) ESCAPE ROUTES 		Illuminated surface area (m) LARGE AREAS 	
		Wall	Ceiling	Wall	Ceiling
Lungaluce 3m	3	-	15	-	-
Lungaluce 7m	7	-	22	-	-
Largaluce 3m	3	-	-	-	12x12
Largaluce 7m	7	-	-	-	13x13
High risk	7	-	-	-	Ø 3m - 30lx
			Lighting >1lx at floor level along the centre line without reflections Emax/Emin <40		Lighting >0.5lx at floor level without reflections Emax/Emin <40

Performance with reference to luminaire **Order Code 19379** 1000lm Maintenance coefficient 0.8

HIGH RISK

89%

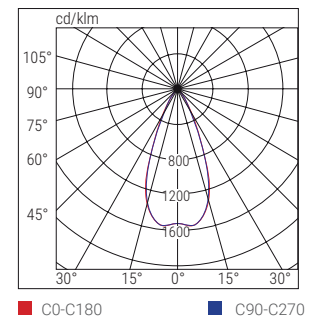

LUNGALUCE 3m 88%

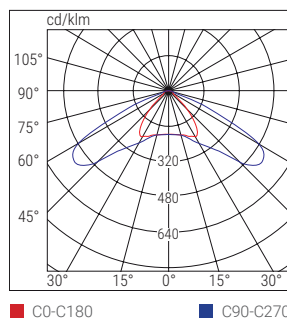

LUNGALUCE 7m 82%

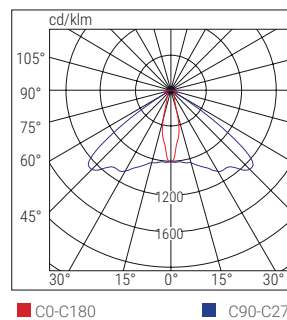

LARGALUCE 3m 92%

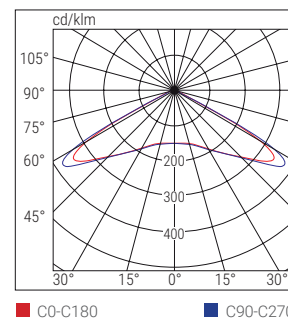

LARGALUCE 7m 89%

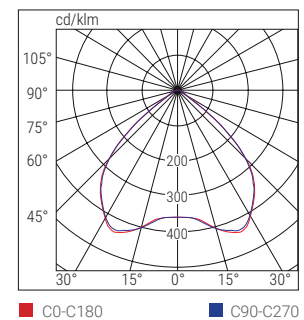

	Order Code	W eq.	Description	Version	Autonomy h	Battery	Flux* SE lm	Flux* SA lm	Input power		Weight Kg	Packaging Single/ Multi pack	
									DC	AC			
AT	19378	24GL	LUNGALARGA EXT GL AT SE	SE	1-1.5-3-8	LiFe 12.8V 3Ah	3200/2500/1400/500			6.5W	0.9	1/6	AUTOTEST
AT-OPT	19370	24	LUNGALARGA EXTREME OPT SA/SE	SA/SE	1-1.5-2-3-8	2xLTO 4.8V 1.2Ah	1155/770/575/385/144	575		7.5W	0.9	1/6	CENTRALISED SELF-TESTING
	LG	Standalone luminaires with Centralised Diagnostics integrating the Module Order No. 15036											
	LGFM	Standalone luminaires with Centralised Radio Diagnostics integrating the Module Order Code 15037											
	DALI	Standalone luminaires with Dali Centralised Diagnostics integrating the Module Order Code 15038											
LG230	31112	24	LUNGALARGA EXTREME LGS230 LS-UV					1400	11.2W	24.1VA	0.9	1/6	CENTRALISED BATTERY
LG24	32083	24	LUNGALARGA EXTREME LGS24 LS-UV				1100	1400	7.4W	22.2VA	0.9	1/6	
HT230	31113	24	LUNGALARGA EXTREME HT					1400	10.7W	22.2VA	0.9	1/6	

* The fluxes shown in the table refer to the luminaire without lens. To identify the actual flux of the product, please consider the yield of the chosen lens in addition to the value shown in the table.

NEXT >

065 Atex emergency

Lungalargaluce Extreme

emergency

ACCESSORIES - included



CABLE GLAND M20 STEEL



LARGALUCE LENS 3m
Fitted as standard



LUNGALUCE LENS 3m



LARGALUCE LENS 7m

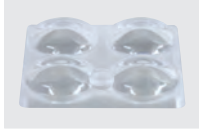

LUNGALUCE LENS 7m



HIGH RISK LENS

ACCESSORIES - to be ordered separately



SWIVEL BRACKET

Order Code **15043**



LG - LGFM - DALI MODULE (AT-OPT version only)

LG - Order Code **15036**

LGFM IP65 - Order Code **15047**

DALI - Order Code **15038**

LG **LGFM** **DALI**



PLASTERBOARD BRACKETS

Order Code **15044**



Stile In SanificaAria

emergency



Hybrid device with uvOxy® air sanitization. Activation regulation by switch in 3 steps: 8, 12, 24 h/day, at a constant sanitization rate. Recessed device with an autonomy of up to 8 hours.

Applications

Service sector, hospitals, commercial activities, shops, restaurants, offices, schools

Emergency features

Power supply unit 230VAC ± 10%, 50÷60Hz

Mounting Wall mounting, ceiling mounting, recessed mounting, false ceiling mounting

Recharging time 12h

Body Polycarbonate, white RAL 9003

Optics PMMA anti-glare diffuser

Screen Clear polycarbonate

Compliance EN60598-1, EN60598-2-2, EN60598-2-22, EN60335-2-65, ISO 15714, 2014/30/EU, 2014/35/EU

Specifications of the Air Sanitizer

Power supply unit 230VAC ±10%, 50÷60Hz

Input power uvOxy® 10 W

UV-C wavelength 254 nm

Sanitization flow rate 4 m³/h

UV-C power 7 W

UV-C radiation power 2.4 W

Sanitization speed Single

Timing 8-12-24 h

Cartridge life 12 months

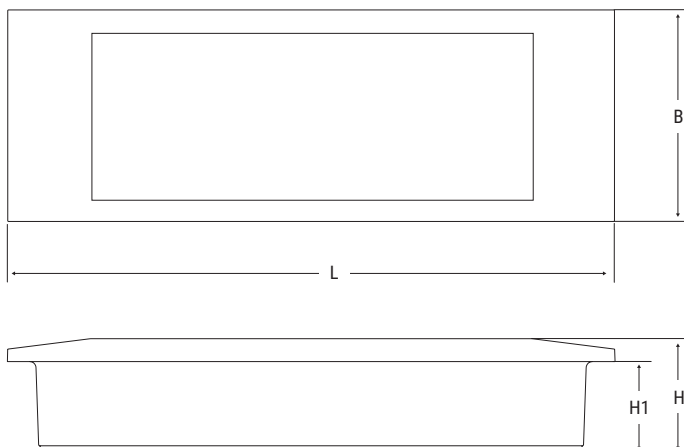

EXAMPLE OF SANITIZATION OF AIR IN AN ENVIRONMENT

Room size		
Volume m³	Surface area m²	Initial sanitization time h
11	4	2.5
21	8	5
33	12.5	8
44	16.5	11
67	25	17

Dimensions mm				Distance of visibility (DV)	
L	B	H	H1	screen	edge mounting
295	102	55	44	15m	20m

Performance according to EN 1838 and initial sanitisation time

STANDARD UNI EN 1838	Height (m)	Centre distance (m) ESCAPE ROUTES		Illuminated surface area (m) LARGE AREAS	
		Wall	Ceiling	Wall	Ceiling
	2.5	5	-	3x3	-
3	-	7	-	5x5	
		>1lx without reflections Emax/Emin <40		>0.5lx along the centre line without reflections Emax/Emin <40	
	Flow rate up to 4 m³/h	Initial sanitisation time 5h		Initial sanitisation time 6h	

Performance based on the 1499LUV 120lm wall-mounted model

STILE IN SanificaAria

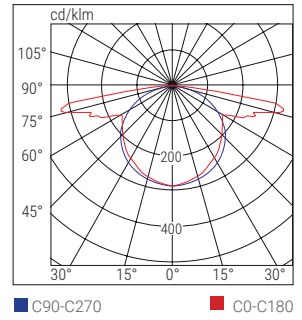

TR	Order Code	W eq.	Description	Version	Autonomy h	Battery	FLUX SE lm	FLUX SA lm	Sanitisation flow rate m³/h			Input power W	Weight Kg	Packaging Single/Multi pack	STANDARD	
									1	2	3					
	1499LUV	8	STILE IN LED SE TR UVOXY	SE	8	LiFe 3.2V 1.5Ah	120	-	4	-	-	2.1	10	0.7	1/12	

ACCESSORIES - included



RECESSED BOX

Order Code **3733**

ACCESSORIES AND SPARE PARTS - to be ordered separately

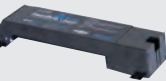

SPARE PART
uvOxy® STILE IN PURIFICATION CARTRIDGE

Duration 12 months, at a continuous use 24h/day

Order Code **26724**



FALSE CEILING BRACKETS

Recessed mounting hole: 279x94 mm

Order Code **4266**



LH/RH/DOWN SCREENS

Screen printing on opal polycarbonate

Order Code **4269**

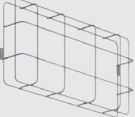

PROTECTIVE GRILLE

Dimensions: 440x215x99 mm

Order Code **3912**



LH/RH/DOWN STICKERS

Order Code **4278**

Pratica SanificaAria

emergency



- IP20
- IK08
- 85°
- Batt. LiFe
- +40°C
0°C
- 8-12-24h
- 1

Hybrid device with uvOxy® air sanitization. Activation regulation by switch in 3 steps: 8, 12, 24 h/day, at a constant sanitization rate. Highly robust body with LiFe battery. Presence of the test button.

Applications

Industry, service sector

Emergency features

Power supply unit 230VAC ± 10%, 50÷60Hz

Mounting Wall mounting, ceiling mounting, suspended mounting, edge mounting, electrified track mounting

Recharging time 12h

Body ABS, white RAL 9003

Optics PMMA anti-glare diffuser

Screen Clear polycarbonate

Conformity EN60598-1; EN60598-2-22, EN60335-2-65, ISO 15714, 2014/30/EU, 2014/35/EU

Specifications of the Air Sanitizer

Power supply unit 230VAC ±10%, 50÷60Hz

Input power uvOxy® 10 W

UV-C wavelength 254 nm

Sanitization flow rate 5 m³/h

UV-C power 7 W

UV-C radiation power 2.5 W

Sanitization speed Single

Timing 8-12-24 h

Cartridge life 12 months

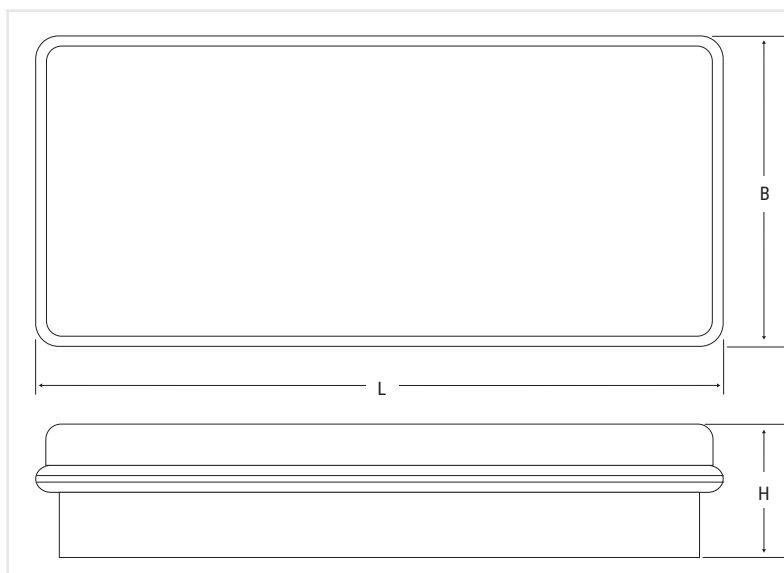

EXAMPLE OF SANITIZATION OF AIR IN AN ENVIRONMENT

Room size		
Volume m³	Surface area m²	Initial sanitization time h
11	4	2
27	10	5
54	20	10
81	30	16
108	40	21

Dimensions mm			Distance of visibility (DV)
L	B	H	
300	138	55	25 m

070

Performance according to EN 1838 and initial sanitisation time

STANDARD UNI EN 1838	Height (m)	Centre distance (m) ESCAPE ROUTES		Illuminated surface area (m) LARGE AREAS	
		Wall	Ceiling	Wall	Ceiling
	2.5	8	-	4x6	-
3	-	9	-	6x7	
		>1lx without reflections Emax/Emin <40		>0.5lx along the centre line without reflections Emax/Emin <40	

	Flow rate up to 5 m³/h	Initial sanitisation time 6h	Initial sanitisation time 12h
--	------------------------	------------------------------	-------------------------------

PRATICA SanificaAria

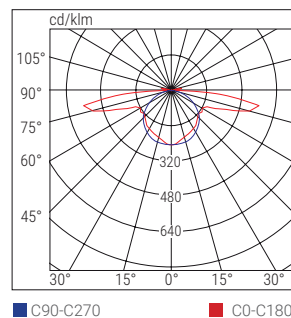

Performance based on the 250SEUV 250lm wall-mounted model

	Order Code	W eq.	Description	Version	Autonomy h	Battery	FLUX SE lm	FLUX SA lm	Sanitisation flow rate m³/h			Input power W	Weight Kg	Packaging Single/Multi pack	
									1	2	3				
TR	250SEUV	18	PRATICA 300LM 1.5/3h SE TR UVOXY	SE	1.5/3	LiFe 3.2V 1.5Ah	300/160	-	5	-	-	4	10	0.8	1/12
	250SAUV	18	PRATICA 300LM 1.5/3h SA TR UVOXY	SA/SE	1.5/3	LiFe 3.2V 1.5Ah	300/160	200	5	-	-	4	10	0.8	1/12
	500SEUV	24	PRATICA 500LM 1.5/3h SE TR UVOXY	SE	1.5/3	LiFe 3.2V 3Ah	500/250	-	5	-	-	4	10	0.9	1/12
	500SAUV	24	PRATICA 500LM 1.5/3h SA TR UVOXY	SA/SE	1.5/3	LiFe 3.2V 3Ah	500/250	200	5	-	-	4	10	0.9	1/12
AT	250ATSEUV	18	PRATICA 300LM 1.5/3h SE AT UVOXY	SE	1.5/3	LiFe 3.2V 1.5Ah	300/160	-	5	-	-	4	10	0.8	1/12
	250ATSAUV	18	PRATICA 300LM 1.5/3h SA AT UVOXY	SA/SE	1.5/3	LiFe 3.2V 1.5Ah	300/160	200	5	-	-	4	10	0.8	1/12
	500ATSEUV	24	PRATICA 500LM 1.5/3h SE AT UVOXY	SE	1.5/3	LiFe 3.2V 3Ah	500/250	-	5	-	-	4	10	0.9	1/12
	500ATSAUV	24	PRATICA 500LM 1.5/3h SA AT UVOXY	SA/SE	1.5/3	LiFe 3.2V 3Ah	500/250	200	5	-	-	4	10	0.9	1/12

ACCESSORIES - included

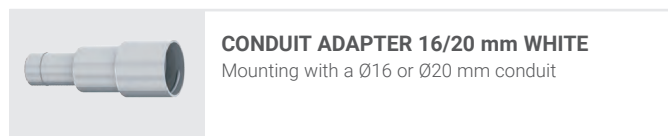

ACCESSORIES AND SPARE PARTS - to be ordered separately

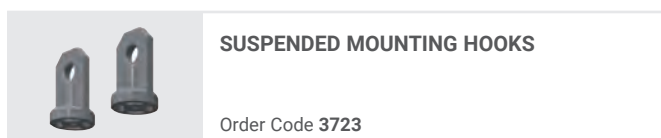
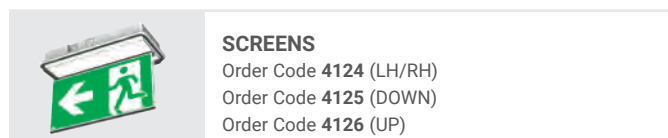
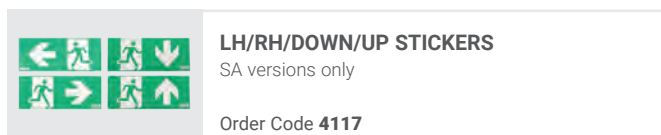
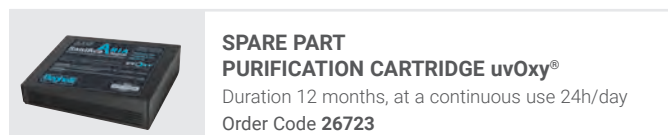

Formula 65 SanificaAria

emergency



IP20
IK07
850°
Batt. LTO
+45°C -20°C
8-12-24h
1
2
3

Hybrid device with uvOxy® air sanitization. Activation adjustable in 3 steps: 8, 12, 24 h/day and at 3 sanitizing speeds. Parameter adjustment from APP B.connect.

Adjustable autonomy in AT version. High luminous flux of up to 1200lm.

Applications

Industry, service sector, hospitals, commercial activities, shops, restaurants, offices, schools

Emergency features

Power supply unit* 230VAC±10%, 50÷60Hz

Mounting Wall mounting, ceiling mounting

Recharging time 12h

Body ABS, white RAL 9003

Optics Symmetrical, white

Screen Clear polycarbonate

Compliance EN60598-1, EN60598-2-22, EN60335-2-65, ISO 15714, 2014/30/EU, 2014/35/EU

Specifications of the Air Sanitizer

Power supply unit 230VAC ±10%, 50÷60Hz

Input power uvOxy® 10 W

UV-C wavelength 254 nm

Sanitization flow rate 8 m³/h

UV-C power 7 W

UV-C radiation power 2.4 W

Sanitization speed 1-2-3 steps

Timing 8-12-24h

Cartridge life 12 months

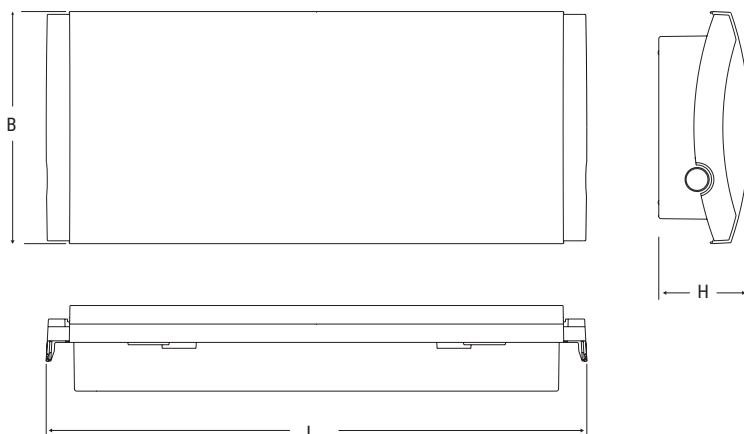

EXAMPLE OF SANITIZATION OF AIR IN AN ENVIRONMENT

Room size		
Volume m³	Surface area m²	Initial sanitization time h
22	8	2.5
43	16	5
86	32	10
135	50	17
202	75	25

Dimensions mm			Distance of visibility (DV)	
L	B	H	Wall	Edge mounting
354	152	63.4	25 m	28 m

Performance according to EN 1838 and initial sanitisation time

FORMULA65 SanificaAria

STANDARD UNI EN 1838	Height (m)	Centre distance (m) ESCAPE ROUTES		Illuminated surface area (m) LARGE AREAS	
		Wall	Ceiling	Wall	Ceiling
	2.5	11	-	8x12	-
3	-	18	-	10x16	
	>1lx without reflections Emax/Emin <40		>0.5lx along the centre line without reflections Emax/Emin <40		

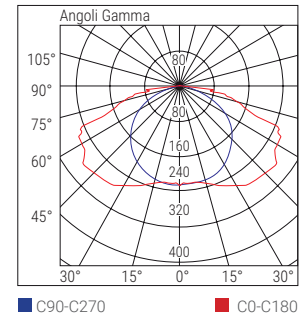

Performance based on the 19430UV 1100lm wall-mounted model - Sanitisation flow rate 3

	Order Code	W eq.	Description	Version	Autonomy h	Battery	FLUX SE lm	FLUX SA lm	Sanitisation flow rate m³/h			Input power W	Weight Kg	Packaging Single/Multi pack		
									1	2	3					
TR	19430UV	36	F65 LED LTO SE UVOXY	SE	1.5	2x LTO 4.8V 1.2Ah	1100	-	2.5	5	8	2	10	1.1	1/6	STD.
	19431UV	36	F65 LED LTO SA UVOXY	SA/SE	1.5	2x LTO 4.8V 1.2Ah	1100	350	2.5	5	8	5	10	1.1	1/6	
AT	19432UV	36	F65 LED LTO AT SE UVOXY	SE	1/3	2x LTO 4.8V 1.2Ah	1200/450	-	2.5	5	8	2	10	1.1	1/6	AUTOTEST
	19433UV	36	F65 LED LTO AT SA UVOXY	SA/SE	1/3	2x LTO 4.8V 1.2Ah	1200/450	350	2.5	5	8	5	10	1.1	1/6	

ACCESSORIES - included

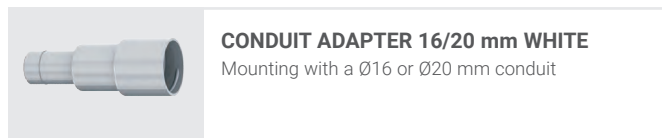
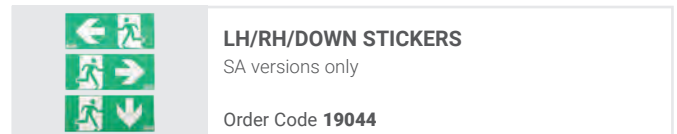
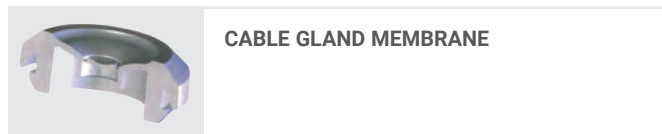

ACCESSORIES AND SPARE PARTS - to be ordered separately

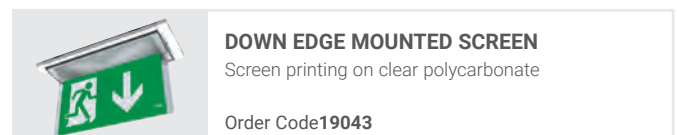
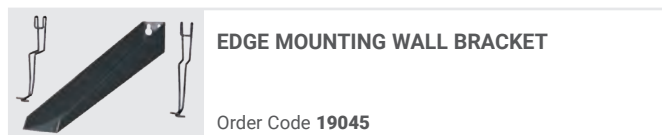
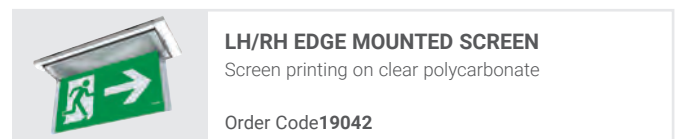
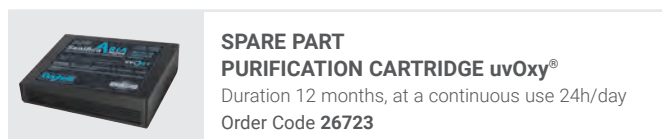

Infinita SanificaAria

emergency



IP20
IK08
850°
Batt. LTO
+45°C / -20°C
8-12-24h
1
2
3

Hybrid device with uvOxy® air sanitization. Activation adjustable in 3 steps: 8, 12, 24 h/day and at 3 sanitizing speeds. Parameter adjustment from B.connect APP and NuBe. Luminous flux up to 1000lm, infinite autonomy, with Infinity mode and Titanium battery.

Applications

Industry, service sector, hospitals, commercial activities, shops, restaurants, offices, schools

Emergency features

Power supply unit* 230VAC ± 10%, 50÷60Hz

Mounting Wall mounting, ceiling mounting, wall/ceiling edge mounting, suspended mounting

Recharging time 12h

Body ABS white RAL 9003

Optics Total Internal Reflection

Screen Clear polycarbonate

Compliance EN60598-1, EN60598-2-2, EN60598-2-22, EN60335-2-65, ISO 15714, 2014/53/EU

Specifications of the Air Sanitizer

Power supply unit 230VAC ± 10%, 50÷60Hz

Input power uvOxy® 10 W

UV-C wavelength 254 nm

Sanitization flow rate 8 m³/h

UV-C power 7 W

UV-C radiation power 2.4 W

Sanitization speed 1-2-3 steps

Timing 8-12-24 h

Cartridge life 12 months

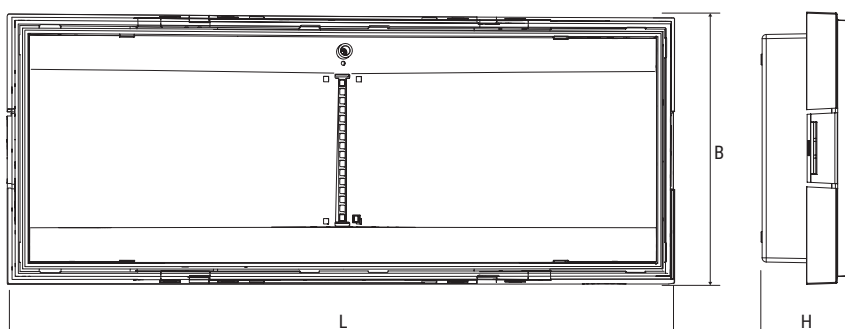

EXAMPLE OF SANITIZATION OF AIR IN AN ENVIRONMENT

Room size		
Volume m³	Surface area m²	Initial sanitization time h
22	8	2.5
43	16	5
86	32	10
135	50	17
202	75	25

Dimensions mm			Distance of visibility (DV)
L	B	H	
325	130	45	25 m

Performance according to EN 1838 and initial sanitisation time

INFINITA SanificaAria

STANDARD UNI EN 1838	Height (m)	Centre distance (m) ESCAPE ROUTES		Illuminated surface area (m) LARGE AREAS		
		Wall	Ceiling	Wall	Ceiling	
	2.5	8	-	6x8	-	
	3	-	10	-	9x10	
	>1lx without reflections Emax/Emin <40		>0.5lx along the centre line without reflections Emax/Emin <40			

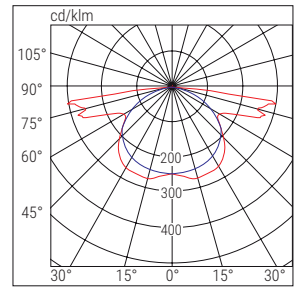

	Flow rate up to 8 m³/h	Initial sanitisation time 4h	Initial sanitisation time 15h
--	------------------------	------------------------------	-------------------------------

Performance based on the 19451UV 500lm wall-mounted model - Sanitisation flow rate 3

	Order Code	W eq.	Description	Vers.	Autonomy h	Battery	FLUX SE lm	FLUX SA lm	Sanitisation flow rate m³/h			Input power W	Weight Kg	Packaging Single/Multi pack	
									1	2	3				
AT-CBL	19450UV	11	INFINITA RTI SE CBL LTO L UVOXY	SE	1/1.5/ 2/3/8	LTO 4.8V 1.2Ah	250/170/130/90/40	-	2.5	5	8	1	10	0.9	1/6
	19451UV	24	INFINITA RTI SE CBL LTO XL UVOXY	SE	1/1.5/2/3/8	LTO 4.8V 1.2Ah	500/340/260/180/70	-	2.5	5	8	2.6	10	0.9	1/6
	19452UV	11	INFINITA RTI SA CBL LTO L UVOXY	SA/SE	1/1.5/2/3/8	LTO 4.8V 1.2Ah	250/170/130/90/40	90	2.5	5	8	1.8	10	0.9	1/6
	19453UV	24	INFINITA RTI SA CBL LTO XL UVOXY	SA/SE	1/1.5/2/3/8	LTO 4.8V 1.2Ah	500/340/260/180/70	250	2.5	5	8	4.8	10	0.9	1/6
	19460UV	24GL	INFINITA GL RTI SA/SE CBL LTO UVOXY	SA/SE	1/1.5/2/3/8	2x LTO 4.8V 1.2Ah	1000/680/525/370/145	250	2.5	5	8	1.8	10	0.9	1/6
	LG	Standalone luminaires with Centralised Diagnostics integrating the Module Order No. 15036													
	LGFM	Standalone luminaires with Centralised Radio Diagnostics integrating the Module Order Code 15037													
	DALI	Standalone luminaires with Dali Centralised Diagnostics integrating the Module Order Code 15038													

ACCESSORIES - included

	CABLE GLAND MEMBRANE		LH/RH/DOWN/UP STICKERS (included for SA versions only) Order Code 4682
	CONDUIT ADAPTER 16/20 mm WHITE Mounting with a Ø16 or Ø20 mm conduit		

ACCESSORIES AND SPARE PARTS - to be ordered separately

	SPARE PART PURIFICATION CARTRIDGE uvOxy® Duration 12 months, at a continuous use 24h/day Order Code 26723		45° BRACKET Order Code 4685
	EDGE MOUNTED SCREEN Order Code 4681		SUSPENDED MOUNTING RODS 250 - 500 - 1000 mm Order Code 4315 (250 mm) - 4316 (500 mm) 4317 (1000 mm)
	EDGE MOUNTING FIXING BRACKET Order Code 4686		LG - LGFM - DALI MODULE LG - Order Code 15036 LGFM - Order Code 15037 DALI - Order Code 15038
	SUSPENDED MOUNTING HOOKS Order Code 3723		CABLECOM CONNECT CBL CONTROL UNIT Order Code 20151



archieco : clean and elegant design lines with surfaces that can be painted together with the wall.

Small size compared to high luminous flux.

Monolithic screen made of shaped methacrylate, designed specifically to optimise light diffusion and to accommodate the pictogram, where required, with an excellent level of light uniformity.

Applications

Services and residential, even in design situations where special care is required to reduce the aesthetic impact of emergency lighting.

Characteristics

Power supply 230VAC ± 10%, 50÷60Hz

Mounting Wall, ceiling

Recharging time 12h

Housing Polycarbonate, white RAL 9003

Optics PMMA

Compliance EN 60598-1, EN 60598-2-22, UNI EN 1838, UNI 11222, EN 62034

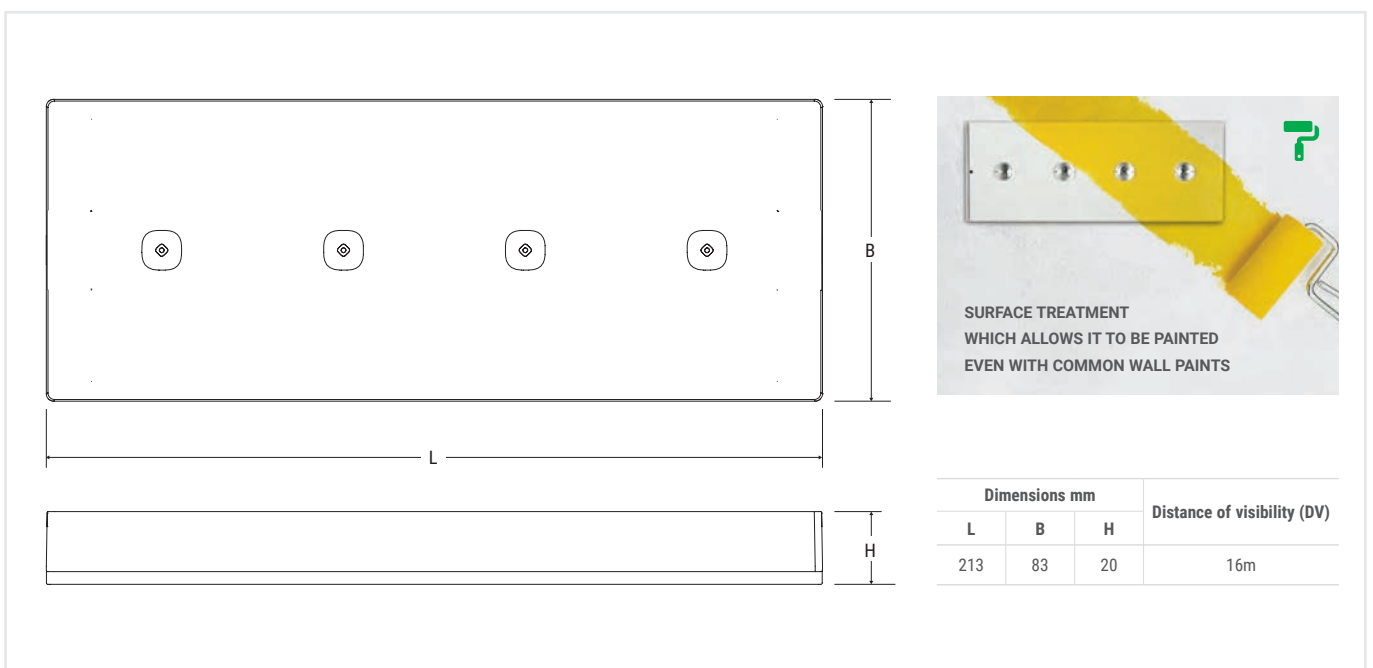

Performance according to EN 1838

Height (m)	Centre distance (m) ESCAPE ROUTES		Illuminated surface area (m) LARGE AREAS	
	Wall	Ceiling	Wall	Ceiling
2.5	7	-	5x6	-
3	-	10	-	7x7
Lighting >1lx at floor level along the centre line without reflections Emax/Emin <40			Lighting >0.5lx at floor level without reflections Emax/Emin <40	
Performance with reference to luminaire Order Code 19601 250 lm			Maintenance coefficient 0.8	

NU.DA

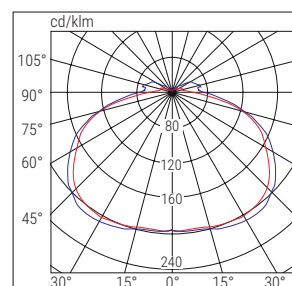

■ C0-C180 ■ C90-C270

	Order Code	W eq.	Description	Version	Autonomy h	Battery	FLUX SE lm	FLUX SA lm	Input power		Weight Kg	Packaging Single/Multi pack
									DC	AC		
TR	19600		NU.DA SE 1/2H LiFe	SE	1/2	LiFe 3.2V 0.5Ah	150/100			1W	0.2	1/12
	19601		NU.DA SE 1.5/3H LiFe	SE	1.5/3	LiFe 3.2V 1.5Ah	250/130			1.3W	0.25	1/12
	19602		NU.DA SE/SA 1/2H LiFe	SA/SE	1/2	LiFe 3.2V 0.5Ah	150/100	100		1.6W	0.2	1/12
	19603		NU.DA SE/SA 1.5/3H LiFe	SA/SE	1.5/3	LiFe 3.2V 1.5Ah	250/130	170		2.5W	0.25	1/12
AT-CBL	19620	11-24	NU.DA 1124W AT CBL SE 8LTO	SE	1/1.5/2/3/8	LTO 4.8V 0.5Ah	250/170/130/85/35			1.7W	0.2	1/12
	19621	24-36	NU.DA 2436W AT CBL SE 8LTO	SE	1/1.5/2/3/8	LTO 4.8V 1Ah	450/305/230/155/65			1.7W	0.25	1/12
	19622	11-24	NU.DA 1124W AT CBL SE/SA 8LTO	SA/SE	1/1.5/2/3/8	LTO 4.8V 0.5Ah	250/170/130/85/35	170		3W	0.2	1/12
	19623	24-36	NU.DA 2436W AT CBL SE/SA 8LTO	SA/SE	1/1.5/2/3/8	LTO 4.8V 1Ah	450/305/230/155/65	170		3W	0.25	1/12
	LG	Standalone luminaires with Centralised Diagnostics integrating the Module Order No. 15036										
	LGFM	Standalone luminaires with Centralised Radio Diagnostics integrating the Module Order Code 15037										
	DALI	Standalone luminaires with Dali Centralised Diagnostics integrating the Module Order Code 15038										

ACCESSORIES - to be ordered separately



LG - LGFM - DALI MODULE

LG - Order Code 15036

LGFM - Order Code 15037

DALI - Order Code 15038

LG

LGFM

DALI



LH/RH/DOWN/UP STICKERS

Order Code 4329



THREE-PHASE TRACK KIT

Order Code 4319

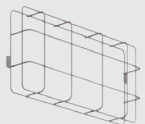

PROTECTIVE GRILLE

Dimensions: 305x110x100 mm

Order Code 3903



Design

emergency



archieco : clean and elegant design lines with surfaces that can be painted together with the wall, made of recyclable and partly compostable materials.



Suitable for both ceiling and wall mounting.



The optical scheme is realised by a double reflection system to obtain an intense and diffusing beam with a soft effect.

Applications

Services and residential, even in design situations where special care is required to reduce the aesthetic impact of emergency lighting.

Characteristics

Power supply 230VAC \pm 10%, 50÷60Hz

Mounting Wall, ceiling, recessed, edge mounting

Housing PHA white RAL 9003

Optics Symmetrical, white

Screen Clear polycarbonate

Compliance EN 60598-1, EN 60598-2-2, EN 60598-2-22, UNI EN 1838, UNI 11222, EN 62034

SURFACE TREATMENT WHICH ALLOWS IT TO BE PAINTED EVEN WITH COMMON WALL PAINTS

Dimensions mm			Distance of visibility (DV)	
L	B	H	Wall	Edge mounting
292	102	34.6	15m	20m

078

Performance according to EN 1838

Height (m)	Centre distance (m) ESCAPE ROUTES		Illuminated surface area (m) LARGE AREAS	
	Wall	Ceiling	Wall	Ceiling
2.5	6	-	3x5	-
3	-	11	-	6x6
Lighting >1lx at floor level along the centre line without reflections Emax/Emin <40			Lighting >0.5lx at floor level without reflections Emax/Emin <40	
Performance with reference to luminaire Order Code 4293A 225 lm			Maintenance coefficient 0.8	

DESIGN

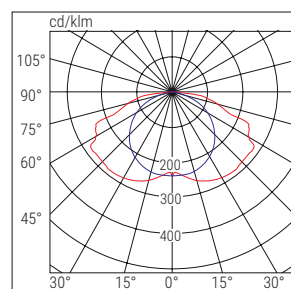

■ C0-C180 ■ C90-C270

	Order Code	W eq.	Description	Version	Autonomy h	Battery	FLUX SE lm	FLUX SA lm	Input power		Weight Kg	Packaging Single/Multi pack
									DC	AC		
TR	4290A	8	DESIGN AE 8W SE 1H IP40	SE	1	NiMH 3.6V 1.2Ah	120	-	1W		0.4	1/12
	4291A	11	DESIGN AE 11W SE 1H IP40	SE	1	NiMH 3.6V 1.2Ah	140	-	1W		0.4	1/12
	4292A	11	DESIGN AE 11W SE/SA 1H IP40	SA/SE	1	NiMH 3.6V 1.2Ah	140	90	2.5W		0.4	1/12
	4293A	24	DESIGN AE 24W SE 1H IP40	SE	1	2 x NiMH 3.6V 1.2Ah	225	-	1W		0.4	1/12
												STANDARD

ACCESSORIES - included

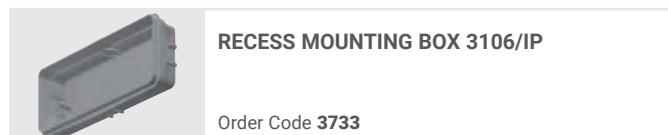

ACCESSORIES - to be ordered separately

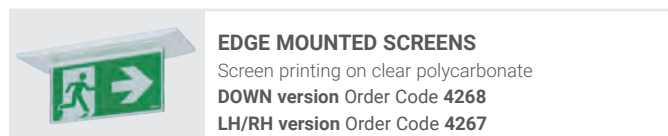
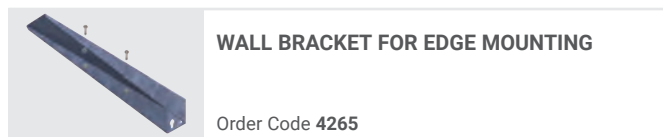
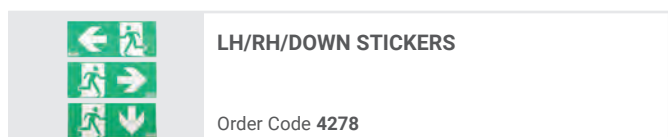
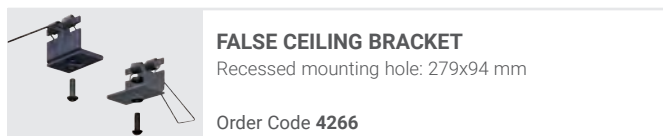
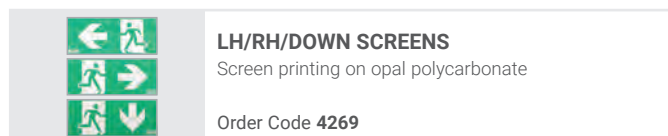

Dot

emergency



IP65
IK07
850°
Batt. LiFe +40°C 0°C
Batt. LTO +45°C -20°C
?



archieco : clean and elegant design lines with surfaces that can be painted together with the wall, made of recyclable and partly compostable materials.



Small dimensions with a luminous flux of up to 1000lm. Possibility to integrate laser signage with an Orma IP65 module.



By rotating the lens, the luminaire is suitable for both large areas (225m²) and escape routes up to 23m.



Double optical scheme made up of two pairs of lenses rotating on the axis and alternatively matching two high-efficiency LEDs.

Applications

Services, offices, cinemas, hotels, museums, schools, shops, shopping centres, design rooms

Characteristics

Power supply 230VAC ± 10%, 50÷60Hz

Mounting Recessed

Recharging time 12h

Housing PHA white RAL 9003

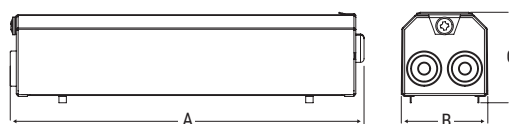
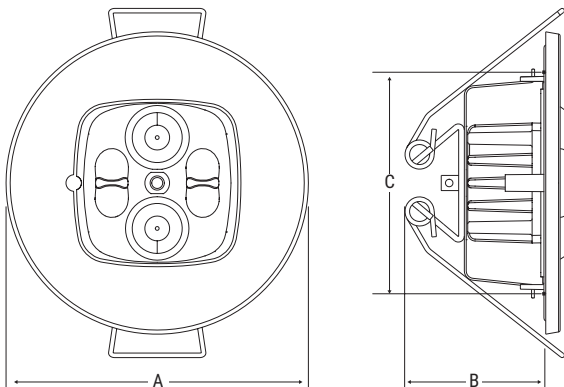

Optics PMMA

Compliance EN 60598-1, EN 60598-2-2, EN 60598-2-22, UNI EN 1838, UNI 11222, EN 62034



	Dimensions mm		
	A	B	C
Luminaire	Ø 80	38	Ø 59
Inverter versions TR-AT	191	47	49
Inverter version LG	254	47	52

Performance according to EN 1838

Lens	Height (m) 	Centre distance (m) ESCAPE ROUTES 		Illuminated surface area (m) LARGE AREAS 	
		Wall	Ceiling	Wall	Ceiling
Lungaluce	3	-	30	-	-
Largaluce	3	-	-	-	14x16

Performance with reference to luminaire Order Code 19712 1000lm

Maintenance coefficient 0.8

LUNGALUCE

80%

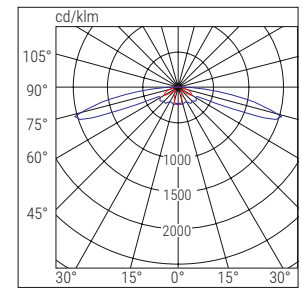

■ C90-C270

■ C0-C180

ORMA LASER MODULE

Laser micro-projector that emits a bright and prominent arrow-shaped asymmetrical conical beam, producing a virtual pictogram to indicate the nearest escape route. To position the image on the ground at the most suitable point and with the correct signal orientation, simply rotate the body of the device.

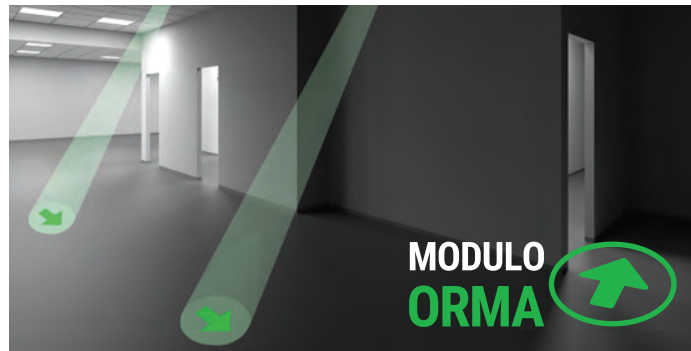

LARGALUCE

91%

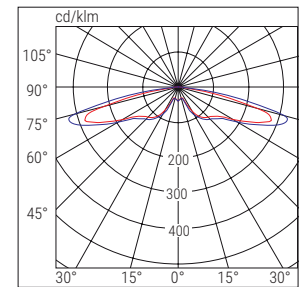

■ C0-C180

■ C90-C270

	Order Code	W	Description	Version	Autonomy h	Battery	FLUX SE lm	FLUX SA lm	Input power		Weight Kg	Packaging Single/ Multi pack	
									DC	AC			
TR	19700		DOT SE/SA 1/2/3H IP65 RM	SA/SE	1/2/3	LiFe 3.2V 1.5Ah	550/300/200	240		3W	0.4	1/6	STANDARD
AT - OPT	19711		DOT AT OPT SE/SA 8LTO IP65	SA/SE	1/1.5/2/3/8	2xLTO 7.2V 0.5AH	550/380/300/200/100	240		5W	0.5	1/6	CENTRALISED SELF-TESTING
	LG		Standalone luminaires with Centralised Diagnostics integrating the Module Order No. 15036										
	LGFM		Standalone luminaires with Centralised Radio Diagnostics integrating the Module Order Code 15037										
	DALI		Standalone luminaires with Dali Centralised Diagnostics integrating the Module Order Code 15038										
LG	19712		DOT GL AT LG SE LIFE IP65	SE	1/2/3	LiFe 12.8V 1.5Ah	1000/550/400	240		4.3W	0.4	1/6	CENTRALISED TEST
	LGFM		Standalone luminaires with Centralised Radio Diagnostics integrating the Module Order Code 19375										
LG230	17880		DOT LGS230 IP65				550		4.7W	9.4VA	0.4	1/6	CENTRALISED BATTERY
LG24	17881		DOT LGS24 IP65				550		4.1W		0.4	1/6	
HT230	17882		DOT HT IP65				550		4.6W	9.1VA	0.4	1/6	

ACCESSORIES - to be ordered separately



ORMA LASER MODULE
Only for Order Code 19700 and 19711

Order Code **19883**



LG - LGFM - DALI MODULE (AT-OPT version only)
LGFM - Order Code **15037 - 19375**
LG - Order Code **15036**
DALI - Order Code **15038**

LG LGFM DALI



LG INIBIT REMOTE CONTROL
RM for LG versions only

Order Code **12101**

LG



RM INIBIT REMOTE CONTROL
RM for TR versions only

Order Code **2730**

RM

Zero

emergency



archieco : clean and elegant design lines with surfaces that can be painted together with the wall, made of recyclable materials.



Revolutionary design with unprecedented aesthetic features.



Emergency luminaire but also safety signage, both single-sided and edge mounted, but also multiple installation solutions.



Three optical solutions to meet any requirement:
 Mirror Silver symmetrical
 Mirror Silver asymmetrical
 Mirror Silver diffusing

Applications

Residential, services, offices, shops, design showrooms

Characteristics

Power supply 230VAC \pm 10%, 50÷60Hz

Mounting Wall, ceiling

Recharging time 12h

Housing Polyester powder-coated pre-galvanised sheet steel, white RAL 9003

Optics Aluminium reflector and PMMA diffuser

Compliance EN 60598-1, EN 60598-2-22, UNI EN 1838, UNI 11222, EN 62034

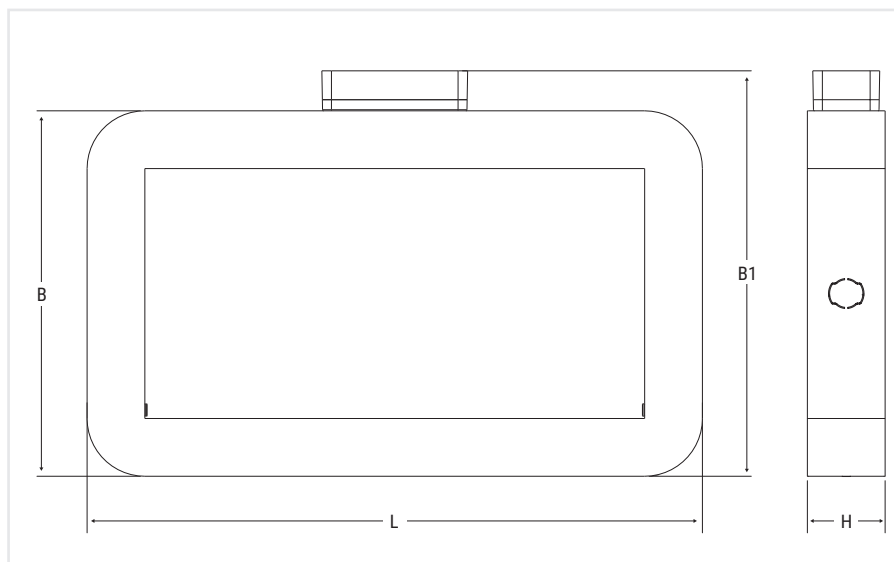

SURFACE TREATMENT
 WHICH ALLOWS IT TO BE PAINTED
 EVEN WITH COMMON WALL PAINTS

Dimensions mm			
L	B	B1	H
277	164.5	182.5	35

082

	Order Code	W	Description	Version	Autonomy h	Battery	FLUX SE lm	FLUX SA lm	Input power		Weight Kg	Packaging Single/Multi pack
									DC	AC		
TR	18200		ZERO SE/SA TR RM	SA/SE	1/2/3	LiFe 3.2V 1.5Ah	1000	450		3W		STANDARD
AT - OPT	18201		ZERO SE/SA OPT	SA/SE	1/1.5/2/3/8	2xLTO 7.2V 0.5AH	1000	450		5W		CENTRALISED SELF-TESTING
	LG	Standalone luminaires with Centralised Diagnostics integrating the Module Order No. 15036										
	LGFM	Standalone luminaires with Centralised Radio Diagnostics integrating the Module Order Code 15037										
	DALI	Standalone luminaires with Dali Centralised Diagnostics integrating the Module Order Code 15038										
LG230	17902		ZERO LGS230 LS-UV				450	450	4.1W	8.3VA		CENTRALISED BATTERY
LG24	17903		ZERO LGS24 LS-UV				450	450	3.7W			
HT230	17904		ZERO HT				450	450	4.7W	9.5VA		

ONE LUMINAIRE, 4 INSTALLATION SOLUTIONS

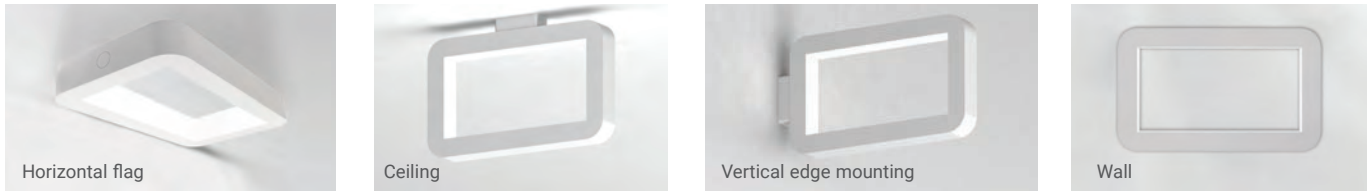

ACCESSORIES - to be ordered separately



LG - LGFM - DALI MODULE (AT-OPT version only)
LG - Order Code **15036**
LGFM - Order Code **15037**
DALI - Order Code **15038**

LG **LGFM** **DALI**



RM INIBIT REMOTE CONTROL
 RM for TR versions only

Order Code **2730**

RM



Design Flag

emergency



A **archieco** : clean and elegant design lines with surfaces that can be painted together with the wall, made of recyclable materials.

☆ Simple, minimalist design for a highly versatile luminaire.

💡 Light diffusion through a sheet of transparent methacrylate that allows great uniformity of illumination of the pictogram.

🔧 One luminaire for all types of mounting, edge mounted on wall, edge mounted on ceiling and single-sided.

Applications

Services, offices, cinemas, hotels, shopping centres, museums, shops, design showrooms

Characteristics

Power supply 230VAC ± 10%, 50÷60Hz

Mounting Wall, ceiling

Recharging time 12h

Housing Extruded aluminium white RAL 9003

Diffuser Transparent polycarbonate

Compliance EN 60598-1, EN 60598-2-22, UNI EN 1838, UNI 11222, EN 62034

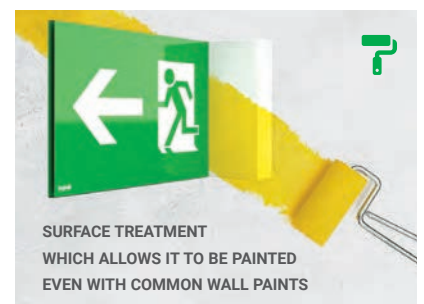
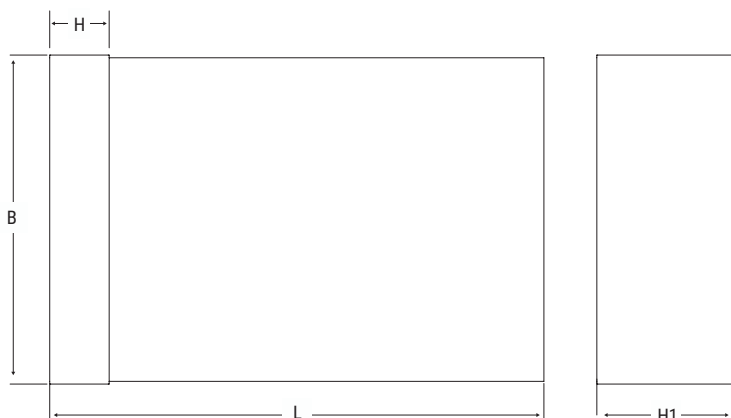
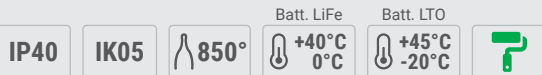

Dimensions mm				Distance of visibility (DV)
L	B	H	H1	
274	183	33	78	36m

	Order Code	W	Description	Version	Autonomy h	Battery	Distance of visibility DV	Input power		Weight Kg	Packaging Single/Multi pack	
								DC	AC			
TR	18400		DESIGN FLAG SE/SA TR RM	SA/SE	1/2/3	LiFe 3.2V 1.5Ah	36m		3W			STANDARD
AT - OPT	18401		DESIGN FLAG SE/SA OPT	SA/SE	1/1.5/2/3/8	2x LTO 7.2V 0.5AH	36m					CENTRALISED SELF-TESTING
	LG	Standalone luminaires with Centralised Diagnostics integrating the Module Order No. 15036										
	LGFM	Standalone luminaires with Centralised Radio Diagnostics integrating the Module Order Code 15037										
	DALI	Standalone luminaires with Dali Centralised Diagnostics integrating the Module Order Code 15038										
LG230	17908		DESIGN FLAG LGS230				36m	2.6W	6.1VA			CENTRALISED BATTERY
LG24	17909		DESIGN FLAG LGS24				36m	2.5W				
HT230	17910		DESIGN FLAG HT				36m	3.1W	6.6VA			

ACCESSORIES - to be ordered separately



LG - LGFM - DALI MODULE (AT-OPT version only)
LG - Order Code **15036**
LGFM - Order Code **15037**
DALI - Order Code **15038**

LG **LGFM** **DALI**



RM INIBIT REMOTE CONTROL
 RM for TR versions only

Order Code **2730**

RM



Ironflag

emergency



IP40

IK05

850°

Batt. LiFe
+40°C
0°C

Batt. LTO
+45°C
-20°C



Designed for durability with an aluminium housing and a PMMA screen.



Signage suitable for any situation. It can be edge mounted, single-sided or suspended. Available in many versions, both for self-contained and centralised battery systems. Special accessories for overhead door lighting and laser signage with Modulo Orma.



Easily detachable housing with ample space inside for quick wiring to the network or to various centralised systems available.

Applications

Services, hotels, hospitals, schools, offices, commercial activities

Characteristics

- Power supply** 230VAC ± 10%, 50÷60Hz
- Mounting** Wall, ceiling, recessed, suspended and above door
- Recharging time** 12h
- Housing** Unpainted aluminium
- Screen** Clear polycarbonate
- Compliance** EN 60598-1, EN 60598-2-2, EN 60598-2-22, UNI EN 1838, UNI 11222, EN 62034

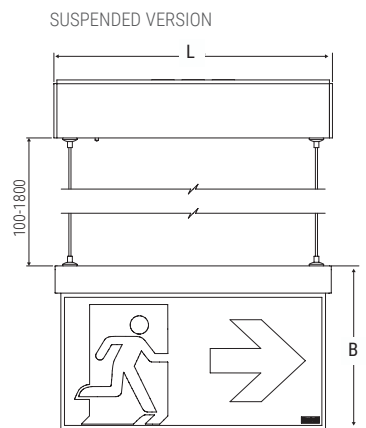
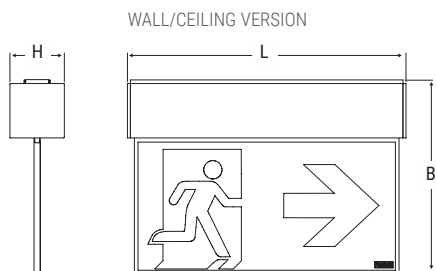

Version	Dimensions mm			Distance of visibility (DV)
	L	B	H	
Standard	230	160	45	20m
	330	210	45	30m
Suspended	230	135	45	20m
	330	185	45	30m



	Version	Order Code	Description	Autonomy h	Battery	Distance of visibility DV	Input power		Weight Kg	Packaging Single/Multi pack		
							DC	AC				
TR	Wall/ceiling	19800	IRONFLAG 20M SA RM	1/2/3	LiFe 3.2V 1.5Ah	20m		3W	0.5	STANDARD		
	Wall/ceiling	19801	IRONFLAG 30M SA RM	1/2/3	LiFe 3.2V 1.5Ah	30m		3W	0.8			
	Suspended	19802	IRONFLAG PEND 20M SA RM	1/2/3	LiFe 3.2V 1.5Ah	20m		3W	0.6			
	Suspended	19803	IRONFLAG PEND 30M SA RM	1/2/3	LiFe 3.2V 1.5Ah	30m		3W	1			
AT - OPT	Wall/ceiling	19810	IRONFLAG AT OPT 20M SA 8LTO	1/1.5/2/3/8	LTO 7.2V 0.5AH	20m		5W	0.5	CENTRALISED SELF-TESTING		
	Wall/ceiling	19811	IRONFLAG AT OPT 30M SA 8LTO	1/1.5/2/3/8	2xLTO 7.2V 0.5AH	30m		5W	0.9			
	Suspended	19812	IRONFL PEND AT OPT 20M SA 8LTO	1/1.5/2/3/8	LTO 7.2V 0.5AH	20m		5W	0.6			
	Suspended	19813	IRONFL PEND AT OPT 30M SA 8LTO	1/1.5/2/3/8	2xLTO 7.2V 0.5AH	30m		5W	1			
		LG	Standalone luminaires with Centralised Diagnostics integrating the Module Order No. 15036									
		LGFM	Standalone luminaires with Centralised Radio Diagnostics integrating the Module Order Code 15037									
		DALI	Standalone luminaires with Dali Centralised Diagnostics integrating the Module Order Code 15038									
LG230	Wall/ceiling	17890	IRONFLAG LGS230 20M			20m	2.6W	6.1VA	0.5	CENTRALISED BATTERY		
	Wall/ceiling	17891	IRONFLAG LGS230 30M			30m	4.1W	8.3VA	0.8			
	Suspended	17892	IRONFLAG PEND LGS230 20M			20m	2.6W	6.1VA	0.6			
	Suspended	17893	IRONFLAG PEND LGS230 30M			30m	4.1W	8.3VA	0.9			
LG24	Wall/ceiling	17894	IRONFLAG LGS24 20M			20m	2.5W		0.5	CENTRALISED BATTERY		
	Wall/ceiling	17895	IRONFLAG LGS24 30M			30m	3.7W		0.8			
	Suspended	17896	IRONFLAG PEND LGS24 20M			20m	2.5W		0.6			
	Suspended	17897	IRONFLAG PEND LGS24 30M			30m	3.7W		0.9			
HT230	Wall/ceiling	17898	IRONFLAG HT 20M			20m	3.1W	6.6VA	0.5	CENTRALISED BATTERY		
	Wall/ceiling	17899	IRONFLAG HT 30M			30m	4.7W	9.5VA	0.8			
	Suspended	17900	IRONFLAG PEND HT 20M			20m	3.1W	6.6VA	0.6			
	Suspended	17901	IRONFLAG PEND HT 30M			30m	4.7W	9.5VA	0.9			





ORMA LASER MODULE



Laser micro-projector that emits a bright and prominent arrow-shaped asymmetrical conical beam, producing a virtual pictogram to indicate the nearest escape route. To position the image on the ground at the most suitable point and with the correct signal orientation, simply rotate the body of the device.

ACCESSORIES - included

	SUSPENDED MOUNTING CABLES SUSPENDE version only
	LH/RH/DOWN SCREENS Screen printing on opal polycarbonate
	WALL BRACKET WALL/CEILING version only

ACCESSORIES - to be ordered separately

	ORMA LASER TR, AT-OPT versions only Installation as an alternative to Code 19882 Order Code 19884	TR AT-OPT
	LIGHT ABOVE DOOR TR, AT-OPT versions only Installation as an alternative to Code 19884 Order Code 19882	TR AT-OPT

	RM INIBIT REMOTE CONTROL RM for TR versions only Order Code 2730	RM
	RECESSED MOUNTING KIT 20m - Order Code 19880 30m - Order Code 19881	

Exit

emergency



 Signage suitable for any industrial or services installation. Available in three sizes with a distance of visibility (DV) of 20, 30 or 60 m. Version with fast-charging Titanium Battery (LTO), with 10 years of service life and for extreme working temperatures.

 Screen-printed screen for more uniform signal illumination

 Innovative concealed fixing system. The same bracket, supplied, is used for both ceiling and edge mounting.

Applications

Services, industry

Characteristics

Power supply 230VAC \pm 10%, 50÷60Hz

Mounting Wall, false ceiling, ceiling with rods and cables, edge mounting on wall, edge mounting on ceiling, three-phase track

Recharging time 12hrs with LTO battery

Housing Polycarbonate, white RAL 9003

Screen Clear polycarbonate

Compliance EN 60598-1, EN 60598-2-22, UNI EN 1838, UNI 11222, EN 62034

DV 20m

DV 30m

DV 60m

W	Dimensions mm			Distance of visibility (DV)
	L	B	H	
2	299	155	30	20m
3	314	194	30	30m
6	629	355	30	60m

	Order Code	W	Description	Version	Autonomy h	Battery	Distance of visibility DV	Input power		Weight Kg	Packaging Single/ Multi pack		
								DC	AC				
TR	4320		EXIT DF20M SA RM	SA/SE	1/2/3	NiMh 3.6V 750mAh	20m		2.5W	0.3	1/6	STANDARD	
	4321		EXIT DF30M SA RM	SA/SE	1/2/3	NiMh 3.6V 1.5Ah	30m		3.5W	0.5	1/6		
	4322		EXIT DF60M SA RM	SA/SE	1/2/3	2xNiMH 3.6V 1.2Ah	60m		6.5W	1	1/3		
AT - OPT	4380		EXIT AT OPT 20M SA 8LTO	SA/SE	1/1.5/2/3/8	LTO 7.2V 0.5AH	20m		7.5W	0.3	1/6	CENTRALISED SELF-TESTING	
	4381		EXIT AT OPT 30M SA 8LTO	SA/SE	1/1.5/2/3/8	2x LTO 7.2V 0.5AH	30m		7.5W	0.5	1/6		
	LG		Standalone luminaires with Centralised Diagnostics integrating the Module Order No. 15036										
	LGFM		Standalone luminaires with Centralised Radio Diagnostics integrating the Module Order Code 15037										
	DALI		Standalone luminaires with Dali Centralised Diagnostics integrating the Module Order Code 15038										
LG230	17911		EXIT LGS230 DF20M				20m	2.5 W	6.1 VA	0.5	1/6	CENTRALISED BATTERY	
	17912		EXIT LGS230 DF30M				30m	3.5 W	8.3 VA	0.5	1/6		
	17913		EXIT LGS230 DF60M				60m	7.0 W		1.0	1/6		
LG24	17914		EXIT LGS24 DF20M				20m	2.5 W		0.5	1/6	CENTRALISED BATTERY	
	17915		EXIT LGS24 DF30M				30m	3.5 W		0.5	1/6		
	17916		EXIT LGS24 DF60M				60m	7.0 W		1.0	1/6		
HT230	17917		EXIT HT DF20M				20m	2.5 W	6.6 VA	0.5	1/6	CENTRALISED BATTERY	
	17918		EXIT HT DF30M				30m	3.5 W	9.5 VA	0.5	1/6		
	17919		EXIT HT DF60M				60m	7.0 W		1.0	1/6		

ACCESSORIES - included



LH/RH/DOWN SCREENS
Screen printing on opal polycarbonate



UNIVERSAL BRACKET

ACCESSORIES - to be ordered separately



CEILING RECESSED MOUNTING ACCESSORY
Distance of visibility (DV) 20-30 m
Order Code **4312** (20 m) - **4313** (30 m)



SUSPENDED MOUNTING ACCESSORY WITH CABLES
Order Code **14771**



THREE-PHASE TRACK KIT
Order Code **4319**



EDGE MOUNTING WALL BRACKET
60m versions only
Order Code **19045**



SUSPENDED MOUNTING RODS
250 - 500 - 1000 mm
Order Code **4315** (250 mm) - **4316** (500 mm) - **4317** (1000 mm)



LG - LGFM - DALI MODULE (AT-OPT version only)
LG - Order Code **15036**
LGFM - Order Code **15037**
DALI - Order Code **15038**



RM INIBIT REMOTE CONTROL
RM for TR versions only
Order Code **2730**

RM

UpLED Bandiera IP65

emergency



 IP65 flag with a 40m visibility distance.

 Wall or ceiling mounting and accessories for special mounting, such as the three-phase track kit.

 Quick installation with IP65 accessories with snap-on fixing of the flag screen without the need for tools.

Applications

Industry, services, hospitals, schools, retail where a high visibility distance is required

Characteristics

Power supply 230VAC \pm 10%, 50÷60Hz

Mounting Wall, ceiling, three-phase track

Housing Polycarbonate, white RAL 9003

Screen Opal polycarbonate

Compliance EN 60598-1, EN 60598-2-22, UNI EN 1838, UNI 11222, EN 62034

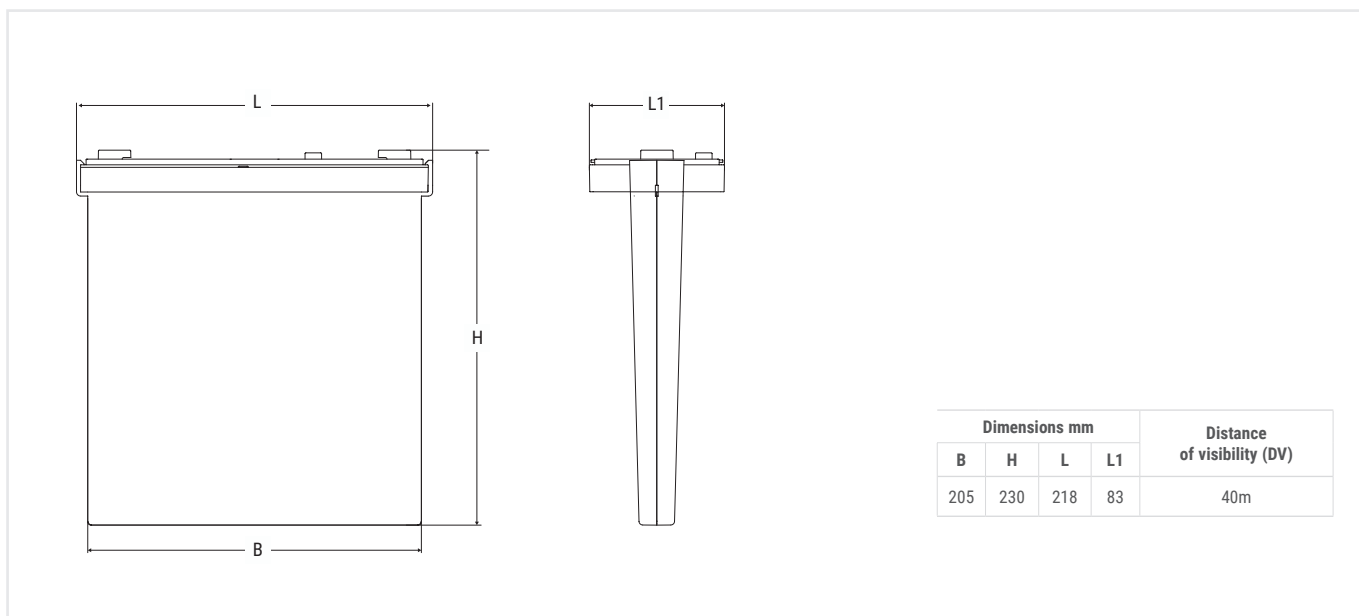

Dimensions mm				Distance of visibility (DV)
B	H	L	L1	
205	230	218	83	40m

090

	Order Code	W	Description	Version	Autonomy h	Battery	Distance of visibility DV	Input power		Weight Kg	Packaging Single/ Multi pack		
								DC	AC				
TR	824BA		UP LED BAND 824BA SE/SA IP65 RM	SA/SE	1.5	NiCd 3.6V 0.75Ah	40m		2W	0.5	1/12	STD.	
AT-OPT	4372BA		UP LED BAND IP65 ATOPT SA 8LTO	SA/SE	1/1.5/2/3/8	LTO 4.8V 0.5Ah	40m		7.5W	0.3	1/12	CENTRALISED SELF-TESTING	
	LG	Standalone luminaires with Centralised Diagnostics integrating the Module Order No. 15036											
	LGFM	Standalone luminaires with Centralised Radio Diagnostics integrating the Module Order Code 15037											
	DALI	Standalone luminaires with Dali Centralised Diagnostics integrating the Module Order Code 15038											

ACCESSORIES - included

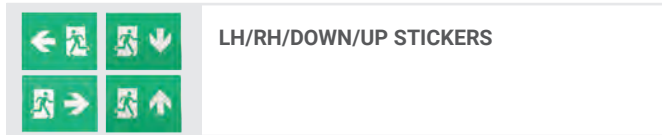
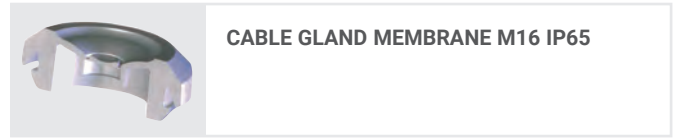
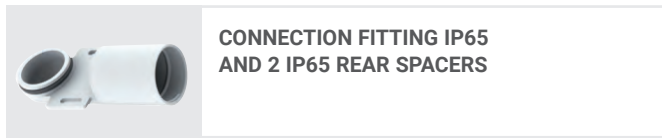

ACCESSORIES - to be ordered separately

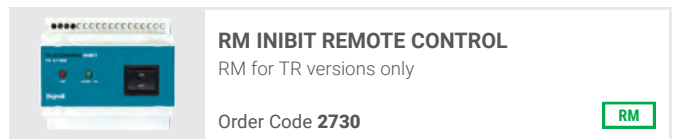
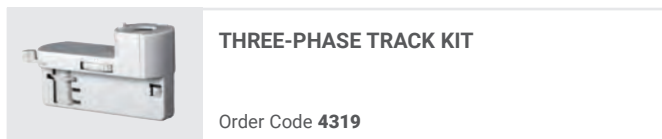

Plug&Light LED Inverter

emergency



Inverter for compact LED luminaires thanks to the integrated battery.



Equipped with cable gland protection covers to allow installation outside the luminaire, without a protection box.



Plug&Light technology for immediate wiring with SD series luminaires - Auto-dimmer already prepared for connection.

Applications

Services, industry, inside IP65 luminaires

Characteristics

Power supply 230VAC \pm 10%, 50 \div 60Hz

Output voltage 20 - 60 VDC (Order Code 19358, 19359), 60 - 180VDC (Order Code 19367)

Max. output current 160 mA

Status LED Two colours with PC light guide (BCS)

Housing Polycarbonate

Compliance EN 61347-2-7, EN 61347-1, EN 60598-1

IP40

IP65

IK08

850°



Batt. NiMH

Batt. NiCd

+40°C
0°C

+40°C
0°C

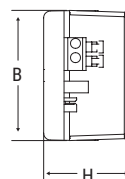
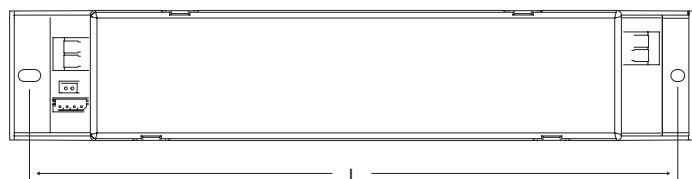
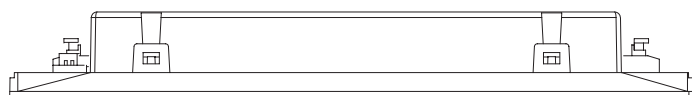

Version	Dimensions mm		
	L	B	H
IP40	239	46	30
IP65	301	139	55

092



EXAMPLE OF FLUX CALCULATION FOR BS 100 LED (SMART DRIVER) WITH LED INVERTER WITH 1H OF AUTONOMY (Order 19358)

The LED Inverter can guarantee the maximum lighting performance that the luminaire on which it is installed can achieve. Please find below the calculation method and an example for determining the Rated Flux in emergency mode

P= Inverter rated power (in the version 1h = 3.2W)
 Fn= Rated luminaire flux (for BS100 LED = 8350lm)
 Pn= Rated power (for BS100 LED = 64W)

$$\text{Flux} = P \text{ inverter} \times \frac{F_n}{P_n} \text{ where: } \text{Flux} = 3.2 \times \frac{8350}{64} = 417\text{lm}$$

BATTERY CONTROL SYSTEM

The signalling LED follows new protocols linked to compliance with standard IEC EN 60598-2-22, where it is expressly required to signal battery malfunctioning, which is instantly signalled by the appearance of the red colour on the multi-coloured signalling LED (BCS Battery Control System).



Green indicator LED:
**LUMINAIRE
 IN FULL WORKING
 ORDER**



Red indicator LED:
**BATTERY NOT
 CONNECTED**



	Order Code	P out Max W	Description	Version	Autonomy h	Battery	FLUX SE lm	FLUX SA lm	Input power		Weight Kg	Packaging Single/Multi pack	
									DC	AC			
TR	IP40												
	19358	3.2	INV PLUG&LIGHT LED SE/SA 1H 20-60V	SA/SE	1	NiCd 7.2V 0.75Ah			1W		0.3	1/12	
	19359	3	INV PLUG&LIGHT LED SE/SA 3H 20-60V	SA/SE	3	NiMH 7.2V 1.5Ah			1W		0.3	1/12	
	19367	3.2	INV PLUG&LIGHT LED SE/SA 1H 60-180V	SA/SE	1	NiCd 7.2V 0.75Ah			1W		0.3	1/12	
	19371	3	INV PLUG&LIGHT LED SE/SA 3H 60-180V	SA/SE	3	NiMH 7.2V 1.5Ah			1W		0.3	1/12	
	IP65												
	19368	3	INV PLUG&LIGHT LED SE/SA 3H 20-60V IP65	SA/SE	3	NiMH 7.2V 1.5Ah			1W		0.8	1/12	
	19373	3	INV PLUG&LIGHT LED SE/SA 3H 60-180V IP65	SA/SE	3	NiMH 7.2V 1.5Ah			1W		0.8	1/12	

ACCESSORIES - included

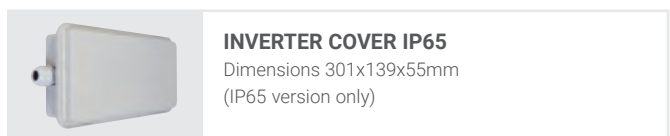
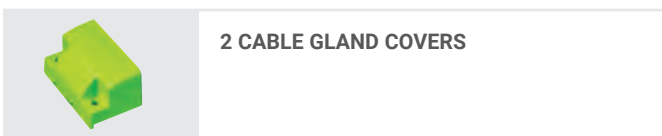

LED Inverter

emergency



Accessory
IP65 enclosure

IP20

IP65

850°

Batt. LiFe

+50°C
0°C

Inverter

+60°C
-20°C



High-performance LED inverter with output current control and constant peak current PWM modulation to drive the LED module optimally without distorting the luminous flux and the colour temperature (K) of the LEDs.



Wide range for self-testing or centralised control luminaires, both wired and radio. Autoripara battery to double the autonomy.

Applications

Services, industry, in high performance IP65 luminaires or with a IP65 enclosure installed.

Characteristics

Power supply 230VAC \pm 10%, 50÷60Hz

Output voltage 5V - 55V

P in max driver 1500VA

V in max driver 250VAC

Recharging time* 12hrs

Max. output current 500mA

Status LED Two colours

Housing Polycarbonate

Compliance EN 61347-2-7, EN 61347-2-13, EN 61347-1, EN 62034

* The time refers to the battery included with the luminaire. The charging time doubles when the Autoripara battery is used.



INVERTER

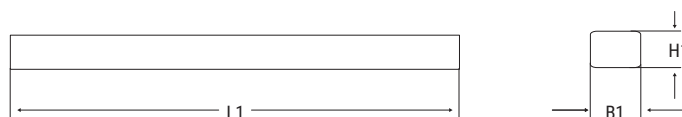

BATTERY

Dimensions mm					
L	B	H	L1	B1	H1
232	30	26	72	60	20



EXAMPLE OF FLUX CALCULATION FOR BS 100 LED (SMART DRIVER) WITH LED INVERTER WITH 1H OF AUTONOMY (Order 19355L)

The LED Inverter can achieve an excellent lighting performance of the luminaire on which it is installed. Please find below the calculation method and an example for determining the Rated Flux in emergency mode

P= Inverter rated power (in the version 1h = 7W)
 Fn= Rated luminaire flux (for BS100 LED = 8350lm)
 Pn= Rated power (for BS100 LED = 64W)

$$\text{Flux} = P \text{ inverter} \times \frac{F_n}{P_n} \text{ where:}$$

$$\text{Flux} = 7 \times \frac{8350}{64} = 913\text{lm}$$

The calculation does not take into account the improved efficiency of the luminaire when driven with very low power compared to the nominal values, in which case the fluxes are underestimated.

POWER TREND ACCORDING TO LED VOLTAGE

The output power is subordinated to the maximum output current of 500mA (e.g., with the inverter set to 1h of autonomy, it will guarantee a 7W output when only used to power an LED set with Vled>14Volt; below this voltage, the power is reduced as shown in the graph.

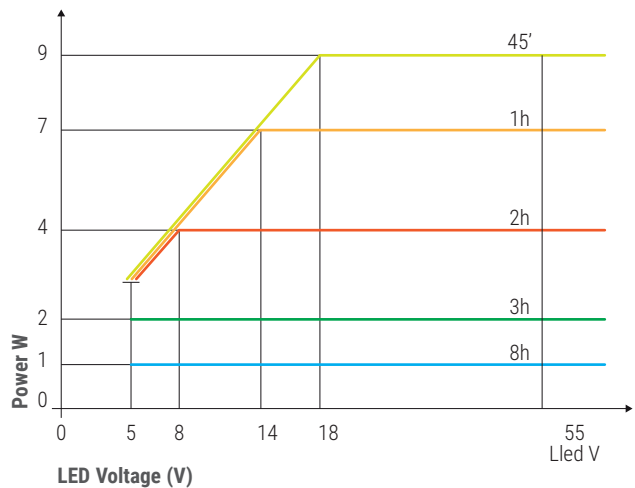

Order Code	P out Max W	Description	Version	Autonomy h	Battery	P out W	Batt. AUTORIPARA OPTIONAL Autonomy h	Input power		Weight Kg	Packaging Single/Multi pack
								DC	AC		
19355L	9	INVERTER LED AT/LG AR 9W 55V LIFE	SA/SE	0.75/1/2/3/8	LiFe HT 9.6V 1.5Ah	9/7/4/2/1	1.5/2/4/6/16	2W		0.3	1/12

LGFM Standalone luminaires with Centralised Radio Diagnostics integrating the Module Order Code 19375

ACCESSORIES - to be ordered separately



AR - AUTORIPARA BATTERY
 Compatible with Order Code 19355L
 Order Code **RA06** - LIFE 9.6V 1.5Ah



INVERTER COVER IP65
 Dimensions 301x139x55mm
 Order Code **19376**



LGFM module
 Order Code **19375 (LGFM)**

GranLuce LED inverter

emergency



Accessory IP65 enclosure

IP20 IP65 850°

Batt. LTO +45°C -20°C

Batt. LiFe +50°C -0°C

Inverter +60°C -20°C



LED inverter with a luminous flux of up to 2000lm, for high-performance luminaires. Extreme working conditions thanks to special lithium batteries.



Wide range for Autotest and radio centralised control luminaires. Autoripara battery to double the autonomy.



Quick wiring and optional IP65 enclosure for installation outside the luminaire.

Applications

Services, industry, in high performance IP65 luminaires or with a IP65 enclosure installed even outdoors.

Characteristics

Power supply 230VAC \pm 10%, 50÷60Hz

Output voltage 5V - 55V

P in max driver 1500VA

V in max driver 250VAC

Recharging time* 12hrs

Max. output current 500mA

Status LED Two colours

Housing Polycarbonate

Compliance EN 61347-2-7, EN 61347-2-13, EN 61347-1, EN 62034

* The time refers to the battery included with the luminaire. The charging time doubles when the Autoripara battery is used.

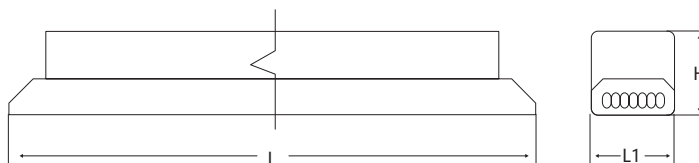

INVERTER

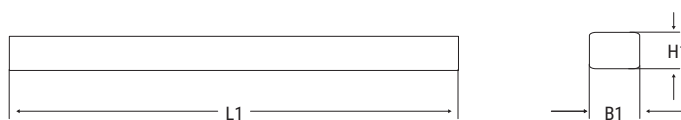

BATTERY

Version	Dimensions mm					
	L	B	H	L1	B1	H1
LTO	232	30	26	198	37	19
LiFe	232	30	26	132	37	19



1h autonomy 1304lm flux

EXAMPLE OF FLUX CALCULATION FOR BS 100 LED (SMART DRIVER) WITH LED INVERTER WITH 1H OF AUTONOMY (Order 19390)

The GranLuce LED Inverter can to guarantee the maximum lighting performance that the luminaire on which it is installed can achieve. Please find below the calculation method and an example for determining the Rated Flux in emergency mode

P= Inverter rated power (in the version 1h = 10W)
 Fn= Rated luminaire flux (for BS100 LED = 8350lm)
 Pn= Rated power (for BS100 LED = 64W)

$$\text{Flux} = P \text{ inverter} \times \frac{F_n}{P_n} \text{ where: } \text{Flux} = 10 \times \frac{8350}{64} = 1304\text{lm}$$

The calculation does not take into account the improved efficiency of the luminaire when driven with very low power compared to the nominal values, in which case the fluxes are underestimated.

POWER TREND ACCORDING TO LED VOLTAGE

The output power is subordinated to the maximum output current of 500mA (e.g. with the inverter set to 1h of autonomy, it will guarantee a 10W output when only used to power an LED set with Vled>20V; below this voltage, the power is reduced as shown in the graph.

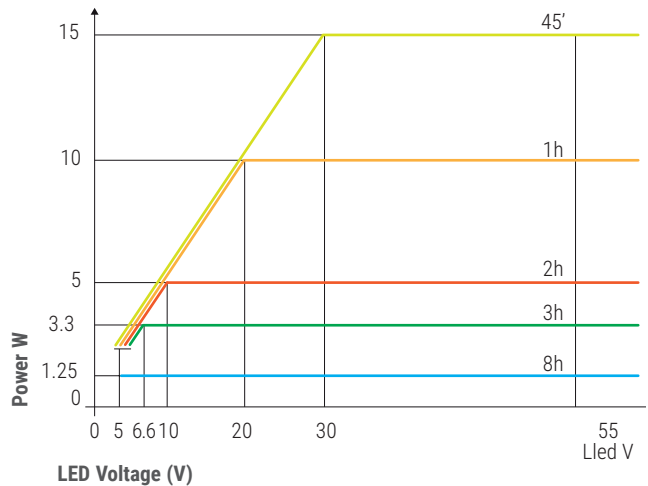

	Order Code	P out Max W	Description	Version	Autonomy h	Battery	P out W	Batt. AUTORIPARA OPTIONAL Autonomy h	FLUX SA lm	Input power		Weight Kg	Packaging Single/ Multi pack
										DC	AC		
LG	19390	15W	INVERTER GL AT/LG AR 15W 55V LTO	SA/SE	0.75/1/2/3/8	LTO 14.4V 1.2Ah	15/10/5/3.3/1.25	1.5/2/4/6/16			3.7	0.3	1/12
	19391*	15W	INVERTER GL AT/LG AR 15W 55V LIFE	SA/SE	0.75/1/2/3/8	LiFe 12.8V 1.5Ah	15/10/5/3.3/1.25	1.5/2/4/6/16			3.7	0.3	1/12
	LGFM	Standalone luminaires with Centralised Radio Diagnostics integrating the Module Order Code 19375											

* 5-year warranty

ACCESSORIES - to be ordered separately



AR - AUTORIPARA BATTERY
Compatible with Order Code **19390**

Order Code **RA07** - LTO 14.4V 1.2Ah



INVERTER COVER IP65
Dimensions 301x139x55mm

Order Code **19376**



AR - AUTORIPARA BATTERY
Compatible with Order Code **19391**

Order Code **RA08** - LiFe 12.8V 1.5Ah



LGFM module

Order Code **19375 (LGFM)**

LGFM

Cablecom Connect CBL Control Unit

emergency



Control unit for CBL Cablecom series luminaires with single power supply wired connection for data transmission and integrated WiFi for remote management from the Beghelli NuBe Cloud.



Newly installed luminaires are preconfigured in AutoTest AT mode. As soon as the CBL Control Unit is connected, they are automatically recognised as centralised luminaires and all programming and centralised monitoring functions are immediately available directly via the Control Unit buttons. By downloading the B.Connect APP, you can connect to the Control Unit and automatically configure the entire system, start functional and autonomy tests, change the parameters of each device and enable advanced functions such as Rest Mode and Infinity Mode.

Applications

Industry, services

Characteristics

Power supply 230VAC $\pm 10\%$, 50=60Hz

Mounting 4 DIN rail modules

Equipment back-up battery

Managed luminaires up to 32 CBL system luminaires

Connection interface

WiFi - AccesPoint (AP) mode and Client (STA) mode, Bluetooth (not enabled)

Management software

B.connect App, NuBe, Cablecom App

Compliance EN62034, EN50172, EN60950-1 2014/53/EU

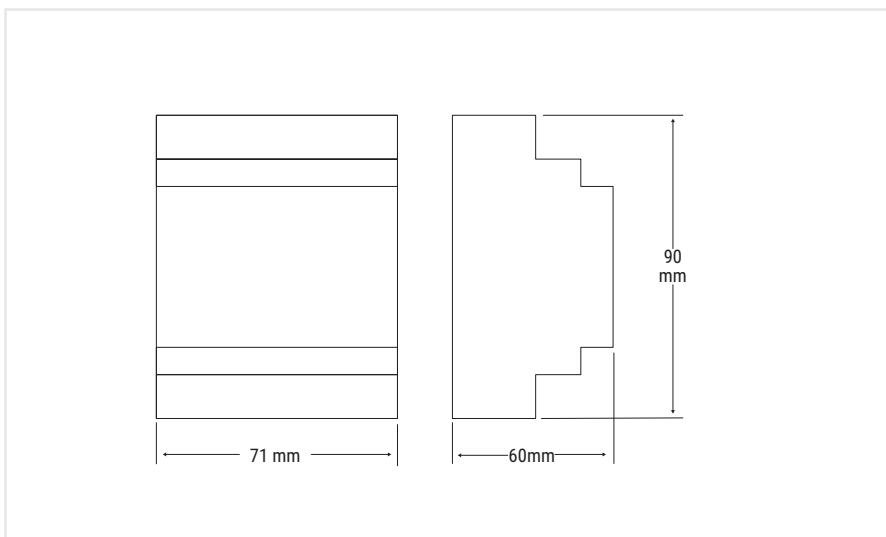

098

FUNCTIONS

- Modular system
- Luminaires operating in both AutoTest and Centraltest CBL modes.
- Programmable autonomy (1-1.5 -2-3-8hrs)
- Delayed testing for part of the system (even/odd)
- Rotary switch for manual programming
- Possibility of remote control via B.connect APP
- Possibility of remote control via PC with the NuBe portal (in addition to GSM, Ethernet, USB, RS232 interfacing)
- Possibility of integration with Building Automation
- Centralised configuration operations
- Activation of Rest Mode function
- Activation of Infinity Mode function
- Automatic download of the system LogBook in PDF format, as required by the EN UNI 11222 Standard

INFINITY MODE, THE INFINITE AUTONOMY SYSTEM

The Infinity Mode function can be activated on all Cablecom (CBL) luminaires, either with the single product in AutoTest AT version (via the B.connect App) or in CentralTest CT version, by activating the specific mode from the control panel of the CableCom Connect Control Unit. Thanks to the CableCom communication BUS, which allows the same cables to be used

both for power supply and for data transmission, in the event of a blackout, when the rated autonomy is over, the CBL Bus will supply the electricity needed to keep the luminaire switched on over an infinite autonomy (at a reduced flux, power supplied from the CableCom CBL BUS line).

	Order Code	Description	Number of luminaires	Number of DIN rail modules	Weight Kg	Packaging Single/ Multi pack
AT-CBL	20151	CABLECOM CONNECT CONTROL UNIT	32	4	0.2	1

ACCESSORIES - to be ordered separately



GSM MODULE
With Ethernet LAN input and power supply (1+1 DIN)
SIM card slot (included)
Order Code **20157**

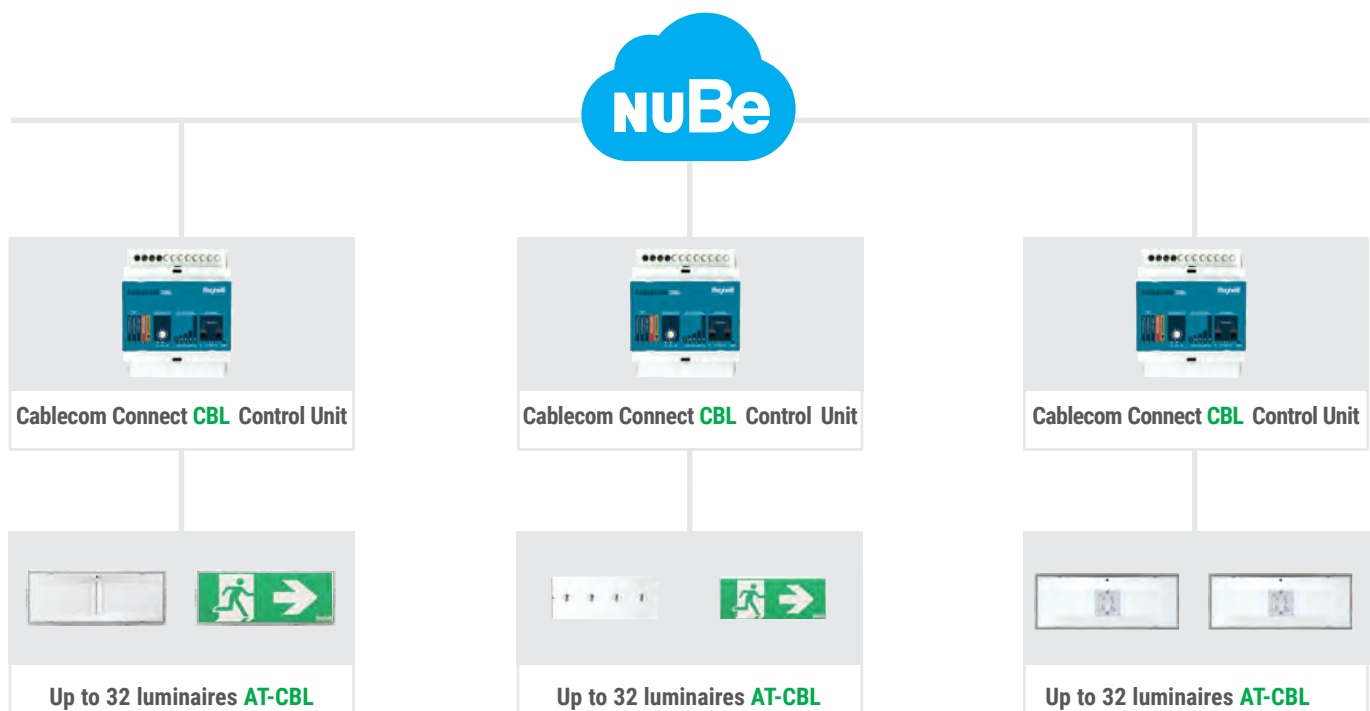

099 control units for self-contained luminaires

Logica Connect LG Control Unit

emergency



Control unit for Logica LG series emergency luminaires with BUS control of the luminaires and integrated WiFi for remote management from the Beghelli NuBe Cloud.



The LG system allows to control a very high number of luminaires (up to 3968) thanks to the combination with the Supervisor Control Unit that, in turn, can control up to 31 LG Control Units. The system is particularly versatile in that, thanks to the Supervisor Control Unit, it overcomes any compatibility problems in systems where there are existing LG Control Units of an older generation, which are in any case integrated into the set and shared in the Beghelli NuBe Cloud.

Applications

Industry, services

Characteristics

Power supply 230VAC $\pm 10\%$, 50÷60Hz

Mounting 4 DIN rail modules

Equipment Relay output and buffer battery

Managed luminaires up to 128 devices per each LG Control Unit; by integrating the Supervisor Control Unit, it is possible to connect 31 control units for a total of 3968 luminaires that can be managed from a single point. In mixed systems, up to 64 DALI devices + 32 LG devices can be controlled.

Connection interface

WiFi - AccesPoint (AP) mode and Client (STA) mode, Ethernet, Bluetooth (not activated), RS485, 4 x potential-free inputs, 1 x 230V input

Management software

B.connect App, NuBe

Compliance EN60950-1, EN62034, EN50172, 2014/53/EU

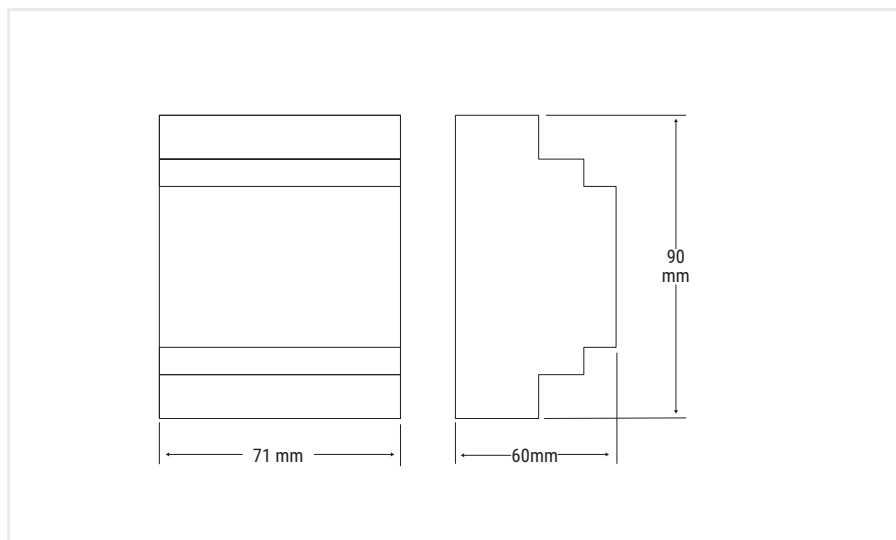

FUNCTIONS

- Modular system
- Luminaires operating in both AutoTest and Centraltest CBL modes.
- Programmable autonomy(1hour / 3hours)
- Delayed testing for part of the system (even/odd)
- Bus Logica wired connections
- Bus DALI-compatible for the management of DALI (LOGICA) luminaires
- Possibility of remote control via B.connect APP
- Possibility of remote control via PC with the NuBe portal (in addition to GSM, Ethernet, USB, RS232 interfacing)
- Possibility of integration with Building Automation
- Centralised configuration operations
- 16 programmable luminaire groups
- 16 programmable brightness scenes

	Order Code	Description	Number of luminaires	Number of DIN rail modules	Weight Kg	Packaging Single/ Multi pack
LG	12100C	LOGICA CONNECT LG CONTROL UNIT	128	4	0.2	1

ACCESSORIES - to be ordered separately



GSM MODULE
With Ethernet LAN input and power supply (1+1 DIN)
SIM card slot (included)
Order Code **20157**



SUPERVISOR CONTROL UNIT
It connects up to 31 LG control units for a total of 3968 controlled luminaires
Order Code **12131C**

NuBe integration scheme for LG Connect systems with older generation LG systems

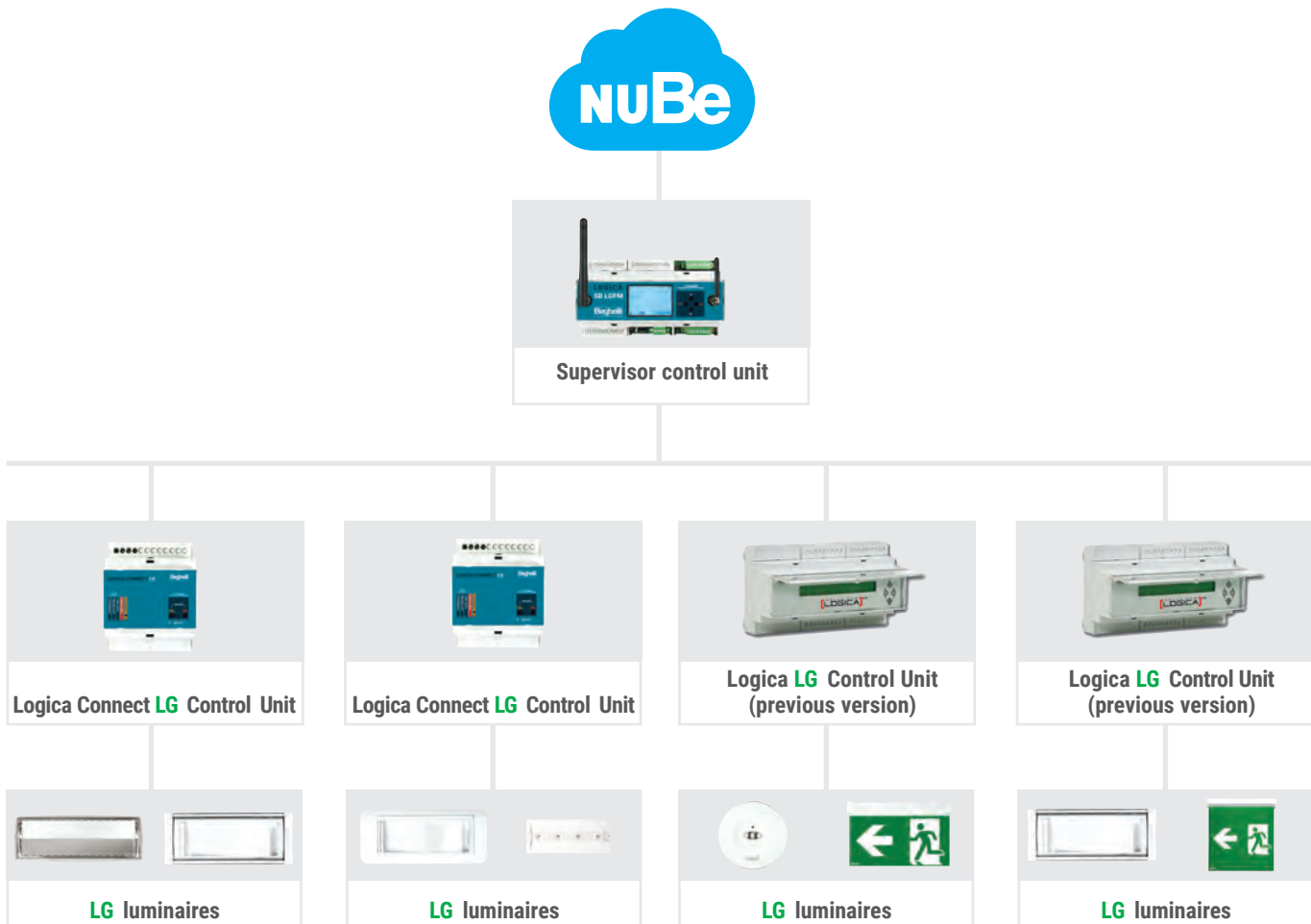

Logica Connect LGFM Control Unit

emergency



Radio control unit for emergency luminaires of the Logica LGFM series with radio control of the luminaires and integrated WiFi for remote management from the Beghelli NuBe Cloud.



The LGFM system allows great flexibility during installation thanks to the radio system that connects the control unit to the luminaires and the luminaires between them without having to add a wired data transmission system. Secure radio transmission with a mesh communication network, where each luminaire acts as a repeater for the next luminaire

Applications

Industry, services

Characteristics

Power supply 230VAC $\pm 10\%$, 50÷60Hz

Mounting 4 DIN rail modules

Equipment Relay output

Managed luminaires

Up to 256 LGFM devices

Connection interface

Radio Spread Spectrum SFH DSSS
WiFi - AccesPoint (AP) mode and Client (STA) mode, Ethernet (1 port), Bluetooth (not activated), RS485, 4 x potential-free inputs, 1 x 230V input

Management software

B.connect App, NuBe, Logica visual

Memory card

SD Card (not included)

Compliance EN60950-1, EN62034, EN50172, 2014/53/EU

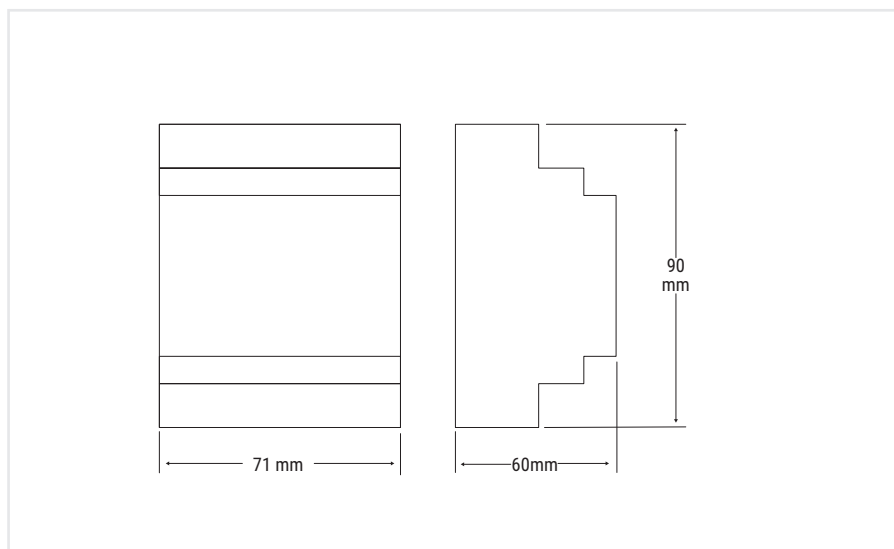

FUNCTIONS

- Modular system
- Luminaires operating in both AutoTest and Centraltest LGFM modes.
- Programmable autonomy(1hour / 3hours)
- Delayed testing for part of the system (even/odd)
- Radio links with SFH DSS system
- Possibility of remote control via B.connect APP
- Possibility of remote control via PC with the NuBe portal (in addition to GSM, Ethernet, USB, RS232 interfacing)
- Possibility of integration with Building Automation
- Centralised configuration operations
- 16 programmable luminaire groups
- 16 programmable brightness scenes

LOW POWER RADIO COMMUNICATIONS BASED ON SPREAD-SPECTRUM TECHNOLOGY UNLIMITED RADIO RANGE

The radio waves used by the Logica FM system are very low power to avoid any kind of interference and electromagnetic pollution. The power involved in radio communication is less than one hundredth of that emitted by a normal mobile phone. The signal transmitted by the Control Unit is received by the first luminaire in the "route" memorised during the control unit

start-up; each luminaire, equipped with a radio transceiver and an amplifier, receives and transmits the signal to the next appliance in the memorised "route".

All products in this range comply with the standards in the European Recommendation ERC/REC 70-03.

	Order Code	Description	Number of luminaires	Number of DIN rail modules	Weight Kg	Packaging Single/ Multi pack
LGFM	12128C	LOGICA CONNECT LGFM CONTROL UNIT	256	4	0.2	1

ACCESSORIES - to be ordered separately



GSM MODULE
With Ethernet LAN input and power supply (1+1 DIN)
SIM card slot (included)
Order Code **20157**

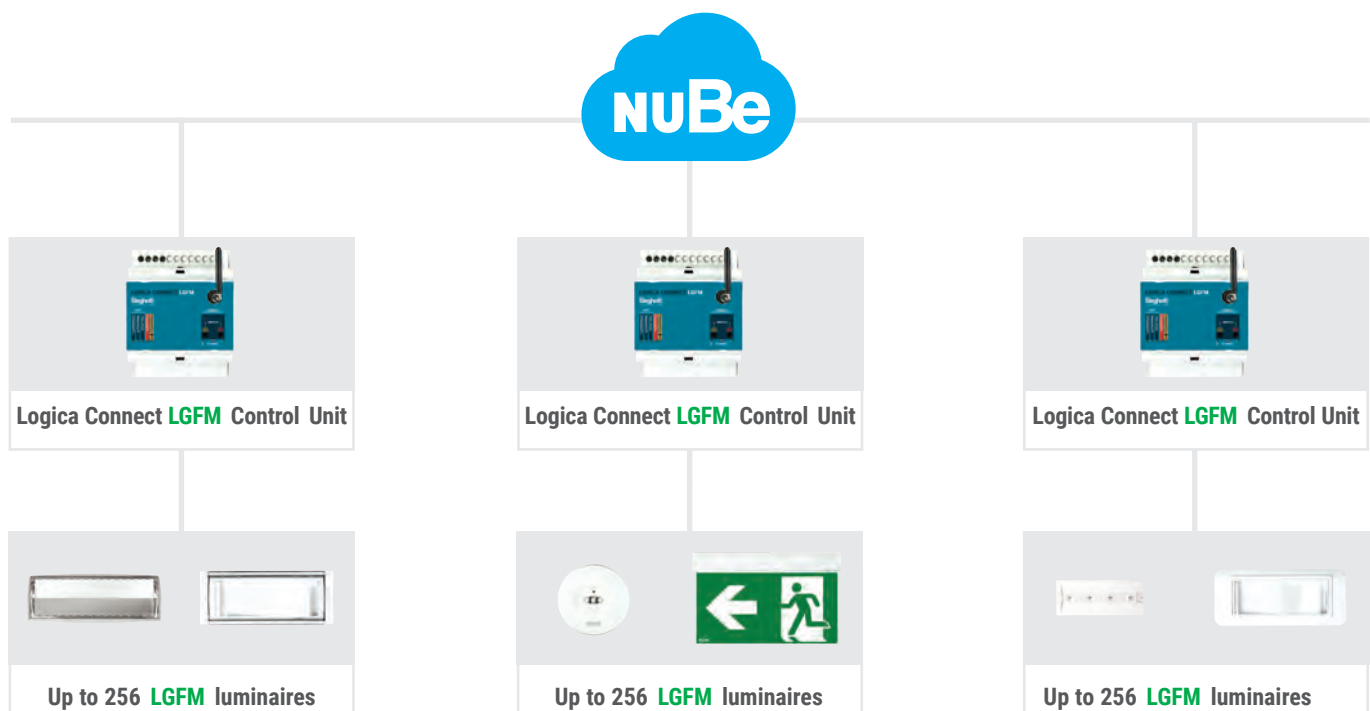

Logica SD LGFM Control Unit

emergency



Control unit for luminaires (SD-X and SD-Radio) and emergency lighting (LGFM) with radio control of the luminaires and integrated WiFi for remote management from the Beghelli NuBe Cloud.



Various types of connections possible and simultaneous management of lighting and emergency. Possibility of acting on each individual luminaire and creating or activating lighting scenarios. Secure radio transmission with improved communication network, where each luminaire acts as a repeater for the next luminaire

Applications

Industry, services

Characteristics

Power supply 230VAC $\pm 10\%$, 50-60Hz

Mounting 9 DIN rail modules

Managed luminaires up to 996 manageable radio devices including lighting lamps, emergency lamps and home automation devices.

Connection interface

SFH DSSS Radio Spread Spectrum on 16 channels, UMTS 4G slot mini SD (SIM included), WiFi - AccesPoint (AP) mode and Client (STA) mode, Ethernet, USB (2 ports), Bluetooth, RS485, RS232, 4 x IN ports and 2 x OUT ports

Management software

B.connect App, NuBe, SD Manager, Logica visual

Memory card

SD Card (not included)

Compliance EN60950-1, EN62034, EN50172, 2014/53/EU

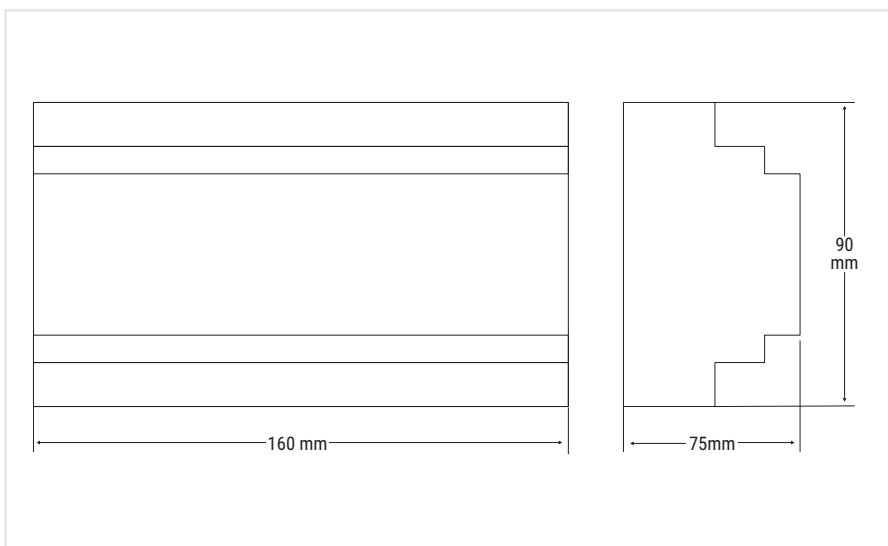

FUNCTIONS

- Setting of the dimmer level
- Definition of operating mode (fixed brightness at a set value or automatic dimming)
- Diagnostics
- Measurement of energy consumption and energy saved
- Creation of lighting scenarios
- Timed switching on/off of lamp groups
- Configuration of the lighting system
- Management of all emergency system functions
- Synchronisation and timing of test functions
- Emergency inhibition/enabling
- Detailed error management
- Alternating (even/odd) autonomy tests to keep 50% of the system always on, even during tests

LOW POWER RADIO COMMUNICATIONS BASED ON SPREAD-SPECTRUM TECHNOLOGY UNLIMITED RADIO RANGE

The radio waves used by the Logica FM system are very low power to avoid any kind of interference and electromagnetic pollution. The power involved in radio communication is less than one hundredth of that emitted by a normal mobile phone. The signal transmitted by the Control Unit is received by the first luminaire in the "route" memorised during the control unit

start-up; each luminaire, equipped with a radio transceiver and an amplifier, receives and transmits the signal to the next appliance in the memorised "route".

All products in this range comply with the standards in the European Recommendation ERC/REC 70-03.

	Order Code	Description	Number of luminaires	Number of DIN rail modules	Weight Kg	Packaging Single/Multi pack
LGFM	21102	SD LOGIC CONTROL UNIT (SIM included)	996	9	0.6	1

System modules



 Expansion modules, to be integrated inside the luminaires, to upgrade to a specific centralised control system allowing connection to the relevant control units (**SD LGFM, LGFM, LG**) or to other centralised systems(**DALI**).

LG MODULE

It allows the expansion of the device for dialogue, via the Logica BUS, with the **Logica LG Control Unit**.

LGFM MODULE

High-frequency transceiver module for spread spectrum radio transmission, which allows luminaires to be radio connected to the **Logica SD LGFM and Logica Connect LGFM control units**.

DALI MODULE

It allows luminaire expansion for dialogue via **DALI BUS** with various control units equipped with DALI protocol data transmission.

	Order Code	Description	IP protection rating	Packaging Single/Multi pack
LG	15036	LG MODULE	IP20	1
LGFM	15037	LGFM MODULE	IP20	1
	15047*	IP65 LGFM MODULE	IP65	1
	19375**	LGFM INVERTER MODULE	IP20	1
DALI	15038	DALI MODULE	IP20	1

* To be combined with LungaLargaLuce Extreme (Code 19370)

** To be combined with INVERTER (19355L, 19390, 19391), STEEL (Cod.15030,15032), DOT (Order 19712)

Inibit remote control

emergency



Inibit control unit for the centralised remote control of the inhibition of the emergency system (Rest Mode function). The connection is via a 2-wire BUS. Available for LG version (4 DIN modules) and RM version (6 DIN modules)

Applications

Industry, services

Characteristics

Power supply 230VAC $\pm 10\%$, 50-60Hz

Mounting 4/6 DIN rail modules

Equipment anti-blackout battery

Managed luminaires up to 128 devices in the LG version, up to 100 devices in the RM version (split over 2 lines 50+50)

Connection interface

WiFi - AccesPoint (AP) mode and Client (STA) mode, Bluetooth (not enabled)

Management software

B.connect App, NuBe (LG version only)

Compliance EN60950-1, EN62034, EN50172, 2014/53/EU

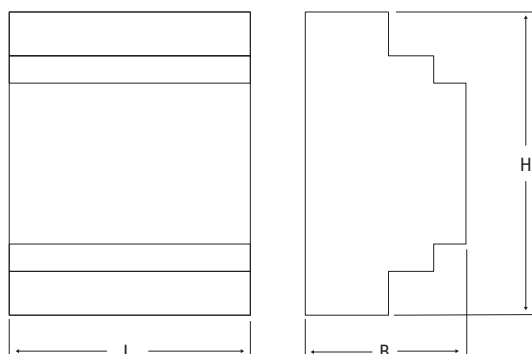

Version	Dimensions mm		
	L	B	H
TR-AT	150	70	90
LG	71	60	90



RM INIBIT REMOTE CONTROL



LG INIBIT REMOTE CONTROL

	Order Code	Description	Number of luminaires	Autonomy	Battery	Mounting	Weight Kg	Packaging Single/Multi pack
TR-AT	2730	973	100	500 activations	Nicd 6V 0.5Ah	DIN rail	0.4	1/6
LG	12101	LG LOGICA REMOTE CONTROL	128	500 activations	NiCd 7.2V 0.75Ah	DIN rail	0.5	1

Logica 230

emergency



Centralised power supply for emergency lighting with diagnostic functions and automatic functional and autonomy tests. Each luminaire performs diagnostics in accordance with UNI 11222 and communicates with the control unit using the power lines to exchange information. A technology by which the Control Unit sends an encrypted transmission to the luminaire to which it is addressed on the power supply lines dedicated to the luminaires, with no possibility of error.



The system allows the composition of a mixed LG230 and LG24 system. It is also possible to connect luminaires, already used for ordinary lighting, in emergency mode by inserting the specific Lamp Module.

Compliance EN50171, 2014/30/EU, 2014/35/EU, EN50172, EN62040-1-1, EN62040-2

CONTROL UNITS AND SUB-UNITS

The LG230 Control Unit is available in many standard configurations ranging from the smallest ST5, to the largest ST24. Furthermore, in order not to lose the great versatility of the system, customised compositions can be made following a specific modular coding that allows you to create your own tailor-made system. Each Control Unit is then integrated into a metal cabinet that contains all the components required for the system. In the case of complex systems or systems divided into different zones, it is advisable to split up the system using the appropriate sub-units, which are also available in different sizes according to the number of lamps and lines to be supplied. In systems with high power, a second cabinet containing the battery pack is provided. The batteries used are 216 VDC (18x12V) sets with an average lifespan of more than 10 years at 20°C.

LG230 CONTROL UNITS



LG230 CONTROL SUB-UNITS



FUNCTIONS

- Control and monitoring of emergency luminaires on the same line, but with a different mode of operation:
- SE mode with switchover to SA mode via external control
- SE mode with selective activation of the emergency function by external monitoring modules
- Selective activation of the emergency function via auxiliary inputs
- Automatic recognition of control lines and modules for the installed luminaires
- Individual monitoring of 32 luminaires per line
- Automatic execution of functional and autonomy tests
- Automatic reporting of tests performed.
- Event logging for two years (LOG-BOOK)

MODULARITY AND SAFETY

Each LG230 Control Unit has a variable number of lines. Each line can control up to 32 luminaires. Each output module can handle 1 (1380W), 2 (2 x 690W) or 4 (4 x 345W) lines depending on the model. The total number of luminaires per output module must not exceed the total power of the line.

The possibility of splitting the emergency lighting supply over

several outputs, all individually protected, introduces a new concept of safety and regulatory compliance that is far superior to the standards of centralised emergency systems.

SUPER SAFETY WITH THE DRM MODULE

DRM
AUTORIPARA

DRM is an optional module made with Titanium batteries, which can be integrated into LG230 luminaires to create a disaster-proof system. If the structure containing the lines of the emergency power supply unit feeding the emergency luminaires fails, the DRM will intervene to ensure emergency lighting in all cases.

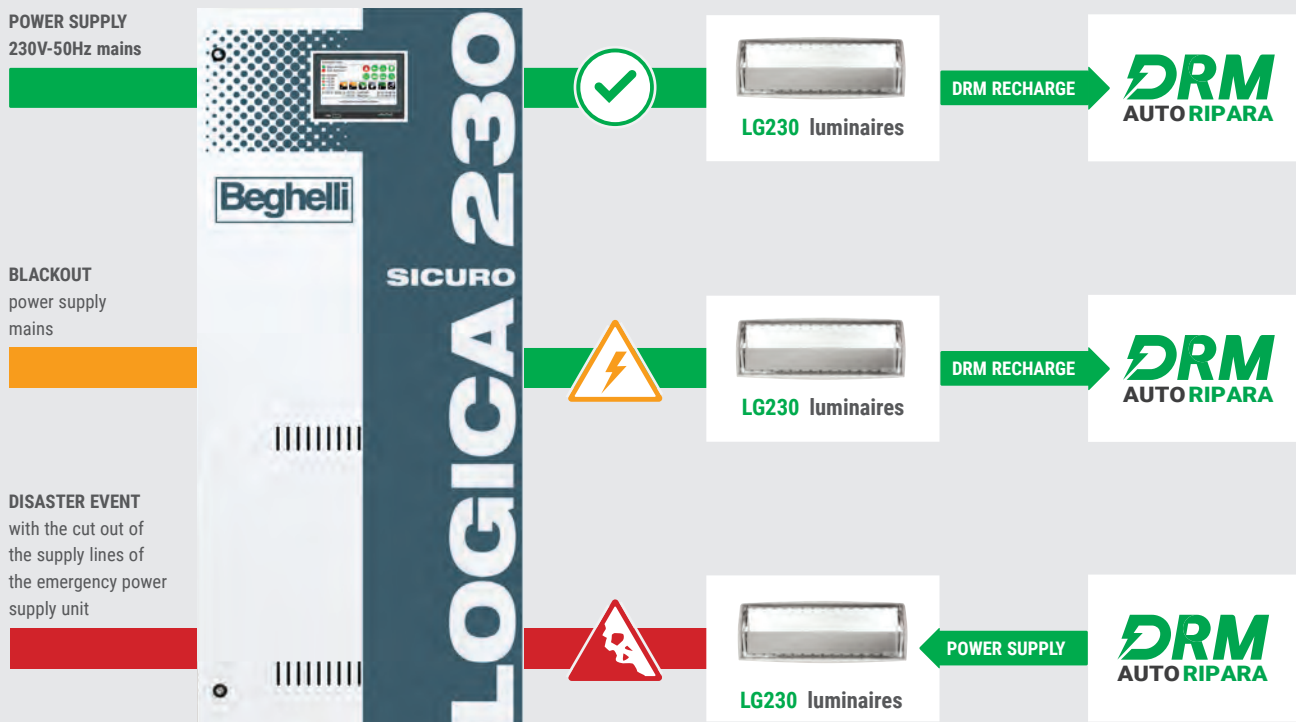

NEXT >

Logica 230

emergency

LG230 - LG24: EXPRESSION OF PURE FUNCTIONALITY

LOGICA 230/24 is a centralised power supply for emergency lighting with diagnostic functions and automatic functional and autonomy tests. The great versatility of the system allows composing a mixed system consisting of 230V modules and 24V modules using LOGICA 230 and LOGICA 24 also in dynamic mode. In addition, it is possible to connect luminaires already used for ordinary lighting as emergency luminaires, by simply inserting the specific Lamp Module, and it is always possible to integrate LOGICA 230/24 into a BMS system (Building Management System). Each luminaire can carry out the diagnostics required by the

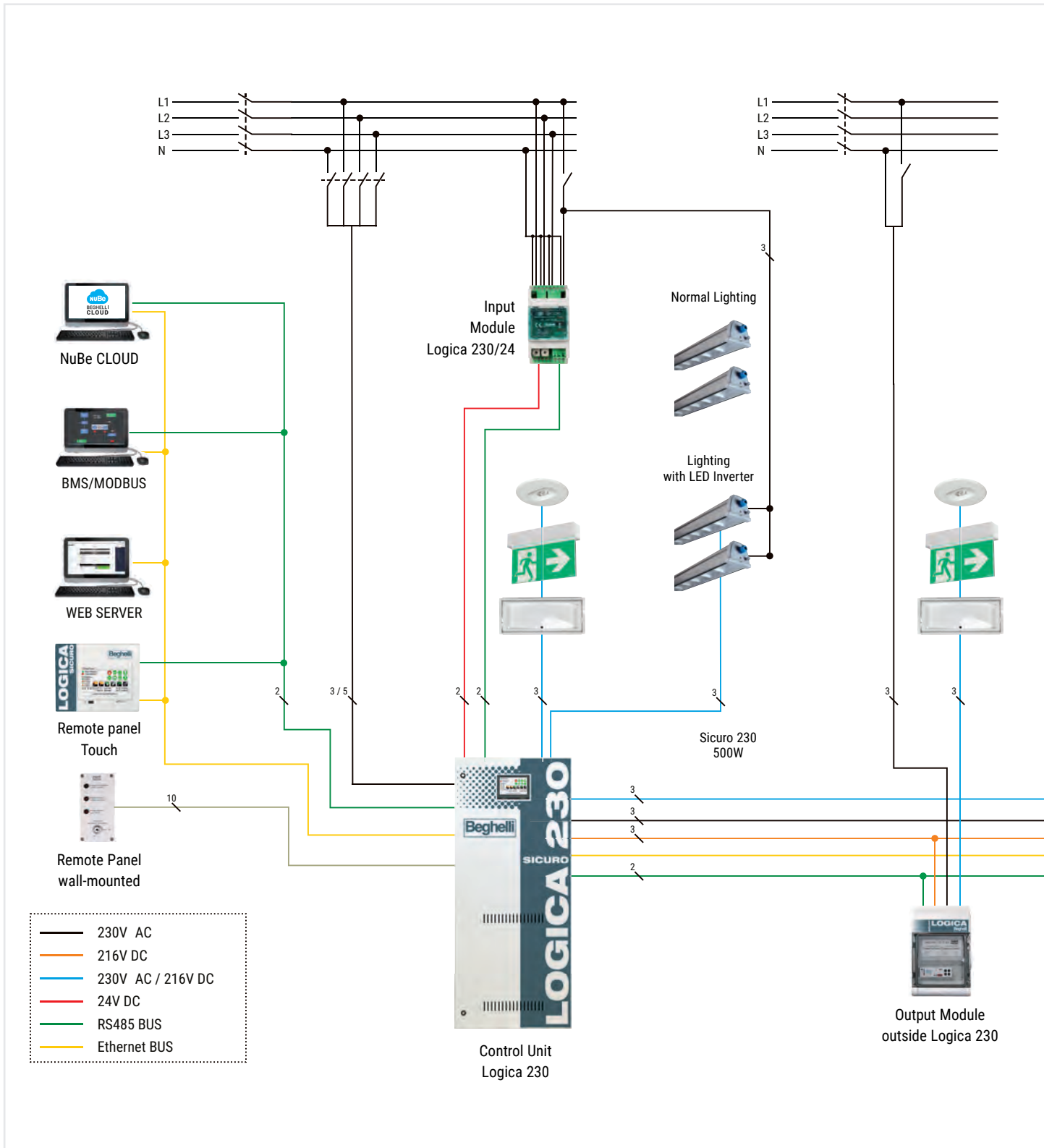

UNI 11222 standard by communicating individually with the control unit using the power supply lines for information exchange by means of the power-line communication technology: the Control Unit sends an encoded digital transmission on the power supply lines dedicated to the luminaires, which transmission is only received by the luminaire to which it is addressed. This technology limits the number of connections and installation cables with obvious savings in material and labour.

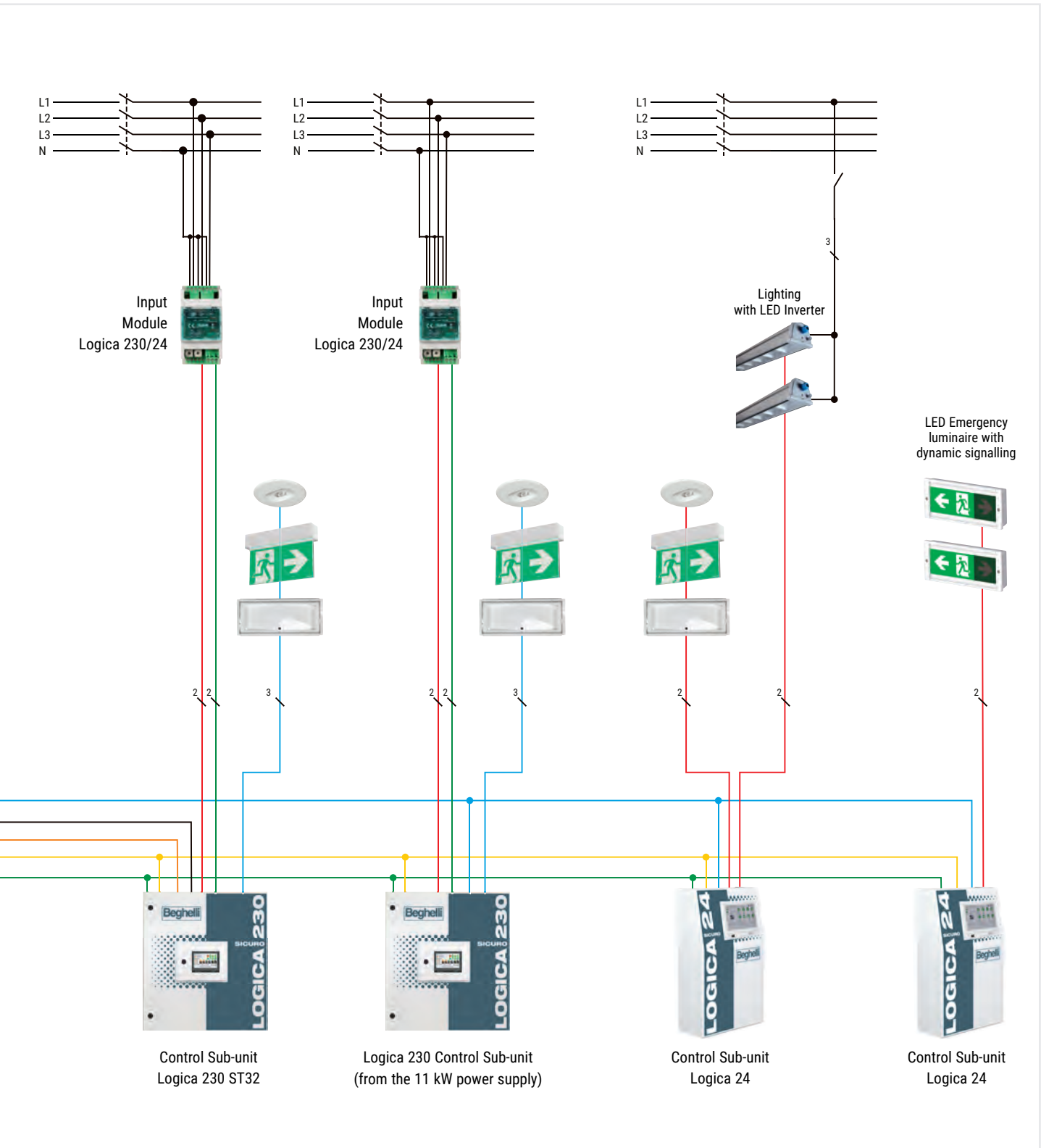

Logica 230

emergency

SELECTION AND CODING OF THE LG230 CONTROL UNIT AND SUB-UNIT

In order not to lose the advantage of the system's great modularity, all compositions that go beyond the standard will have a new coding that, starting from the basic order code, will identify all additional modules:



LG230 Control Unit extended encoding

The first step is to identify the basic LG230 Control Unit that is already encoded and to integrate it with the modules, accessories and sub-units required for the system.

- number of Output Modules with 1, 2 or 4 circuits
- number of 230V Input Modules or potential-free contacts
- number of external Sub-units or Output Modules derived from the Main Control Unit, if any, in the system

Order Code of the Control Unit	Total number	Total number	Total number	Total number
17 _ _ _	-1 / -2 / -4	U _ _ _	I / IC _ _ _	/ K _ _ _ S _ _ _

U = Output Modules:

- **1U** = 1X32 (Code 17233)
- **2U** = 2X32 (Code 17232)
- **4U** = 4X32 (Code 17234)

I = Input Modules **I** = 230V (Code 17230)
IC = 24V (Code 17231)

K = External Output Modules (AK)
S = Outputs for sub-units



LG230 Control Sub-unit extended encoding

As with the control units, the code composition involves the choice of a base code Sub-unit to be integrated with the necessary modules

- number of Output Modules with 1, 2 or 4 circuits
- number of 230V Input Modules

Order Code of the Control Unit	Total number	Total number	Total number
17 _ _ _	-1 / -2 / -4	U _ _ _	I / IC _ _ _ / K _ _ _

U = Output Modules:

- **1U** = 1X32 (Code 17233)
- **2U** = 2X32 (Code 17232)
- **4U** = 4X32 (Code 17234)

I = Input Modules **I** = 230V (Code 17230)
IC = 24V (Code 17231)

K = External Output Modules (AK)

ST5 LG230 CONTROL UNIT



The LOGICA 230 ST5 control unit (5 slots) is integrated into a metal cabinet that contains all system components and battery packs. Each control unit has a variable number of Output and Input Modules, depending on the model. Each output module is divided into 1, 2 or 4 lines, each capable of controlling up to 32 luminaires for a maximum of 1380W for 1x version, 690W for 2x version, 345W for 4x version each line. The LOGICA 230 ST5 Control Unit has a 7" graphic touch screen display mounted on the door and output modules with 19" housings, the batteries are housed directly in the lower part of the Control Unit cabinet.

	Order Code	W	Description	Autonomy h	Modules OUT*	Modules IN**	Number of cabinets Battery	Battery	Power W		Weight Kg
									Nominal***	Max.	
LG230	17601	800	ST5 S230 CONTROL UNIT 7Ah 1P	1h	0	0	-	18 x (12 V 7 Ah)	950	760	107
	17602	500	ST5 S230 CONTROL UNIT 7Ah 2P	2h	0	0	-	18 x (12 V 7 Ah)	561	449	107
	17603	300	ST5 S230 CONTROL UNIT 7Ah 3P	3h	0	0	-	18 x (12 V 7 Ah)	388	310	107
	17604	1500	ST5 S230 CONTROL UNIT 12Ah 1P	1h	0	0	-	18 x (12 V 12 Ah)	1749	1399	138
	17605	800	ST5 S230 CONTROL UNIT 12Ah 2P	2h	0	0	-	18 x (12 V 12 Ah)	972	778	138
	17606	600	ST5 S230 CONTROL UNIT 12Ah 3P	3h	0	0	-	18 x (12 V 12 Ah)	712	570	138

* Modules expandable up to 5 slots - ** Built-in IN modules expandable up to 2 / External IN modules expandable up to 96 - *** 20° environment

STX5 LG230 CONTROL UNIT



The LOGICA 230 ST5 Control Unit (5 slots) is integrated into a metal cabinet that contains all system components and battery packs. Each control unit has a variable number of Output and Input Modules, depending on system requirements, max. 5 slots. Each output module is divided into 1, 2 or 4 lines, each capable of controlling up to 32 luminaires for a maximum of 1380W for 1x version, 690W for 2x version, 345W for 4x version each line. The LOGICA 230 Mini Control Unit has a 7" graphic touch screen display mounted on the door and output modules with 19" housings, the batteries are housed directly in the lower part of the Control Unit cabinet.

	Order Code	W	Description	Autonomy h	Modules OUT*	Modules IN**	Number of cabinets Battery	Battery	Power W		Weight Kg
									Nominal***	Max.	
LG230	17610	1500	STX5 S230 CONTROL UNIT 12Ah 1P	1h	0	0	-	18 x (12 V 12 Ah)	1749	1399	161
	17611	800	STX5 S230 CONTROL UNIT 12Ah 2P	2h	0	0	-	18 x (12 V 12 Ah)	972	778	161
	17612	600	STX5 S230 CONTROL UNIT 12Ah 3P	3h	0	0	-	18 x (12 V 12 Ah)	712	570	161
	17613	2000	STX5 S230 CONTROL UNIT 18Ah 1P	1h	0	0	-	18 x (12 V 18 Ah)	2562	2050	187
	17614	1200	STX5 S230 CONTROL UNIT 18Ah 2P	2h	0	0	-	18 x (12 V 18 Ah)	1466	1173	187
	17615	900	STX5 S230 CONTROL UNIT 18Ah 3P	3h	0	0	-	18 x (12 V 18 Ah)	1065	852	187
	17616	3500	STX5 S230 CONTROL UNIT 28Ah 1P	1h	0	0	-	18 x (12 V 28 Ah)	4481	3585	260
	17617	2000	STX5 S230 CONTROL UNIT 28Ah 2P	2h	0	0	-	18 x (12 V 28 Ah)	2533	2026	260
	17618	1500	STX5 S230 CONTROL UNIT 28Ah 3P	3h	0	0	-	18 x (12 V 28 Ah)	1820	1456	260

* Modules expandable up to 5 slots - ** Built-in IN modules expandable up to 2 / External IN modules expandable up to 96 - *** 20° environment

Logica 230

emergency

ST13 LG230 CONTROL UNIT



The LOGICA 230 ST13 Control Unit (13 slots) is integrated into a metal cabinet that contains all system components and battery packs. Each control unit has a variable number of Output and Input Modules, depending on system requirements, max. 13 slots. Each output module is divided into 1, 2 or 4 lines, each capable of controlling up to 32 luminaires for a maximum of 1380W for 1x version, 690W for 2x version, 345W for 4x version each line. The LOGICA 230 ST13 Control Unit has a 7" graphic touch screen display mounted on the door and output modules with 19" housings, the batteries are housed directly in the lower part of the Control Unit cabinet.

	Order Code	W	Description	Autonomy h	Modules OUT*	Modules IN**	Number of cabinets Battery	Battery	Power W		Weight Kg
									Nominal***	Max.	
LG230	17620	2000	S230 CONTROL UNIT 18Ah 1P	1h	0	0	-	18 x (12 V 18 Ah)	2562	2050	253
	17621	1200	S230 CONTROL UNIT 18Ah 2P	2h	0	0	-	18 x (12 V 18 Ah)	1466	1173	253
	17622	900	S230 CONTROL UNIT 18Ah 3P	3h	0	0	-	18 x (12 V 18 Ah)	1065	852	253
	17623	3500	S230 CONTROL UNIT 28Ah 1P	1h	0	0	-	18 x (12 V 28 Ah)	4481	3585	326
	17624	2000	S230 CONTROL UNIT 28Ah 2P	2h	0	0	-	18 x (12 V 28 Ah)	2533	2026	326
	17625	1500	S230 CONTROL UNIT 28Ah 3P	3h	0	0	-	18 x (12 V 28 Ah)	1820	1456	326
	17626	4500	S230 CONTROL UNIT 33Ah 1P	1h	0	0	-	18 x (12 V 33 Ah)	5404	4323	351
	17627	2500	S230 CONTROL UNIT 33Ah 2P	2h	0	0	-	18 x (12 V 33 Ah)	3019	2415	351
	17628	1800	S230 CONTROL UNIT 33Ah 3P	3h	0	0	-	18 x (12 V 33 Ah)	2161	1729	351
	17629	5500	S230 CONTROL UNIT 44Ah 1P	1h	0	0	-	18 x (12 V 44 Ah)	6710	5368	406
	17630	3200	S230 CONTROL UNIT 44Ah 2P	2h	0	0	-	18 x (12 V 44 Ah)	3846	3077	406
	17631	2200	S230 CONTROL UNIT 44Ah 3P	3h	0	0	-	18 x (12 V 44 Ah)	2776	2221	406
	17632	7000	S230 CONTROL UNIT 55Ah 1P	1h	0	0	-	18 x (12 V 55 Ah)	8609	6887	471
	17633	4000	S230 CONTROL UNIT 55Ah 2P	2h	0	0	-	18 x (12 V 55 Ah)	4980	3984	471
	17634	3000	S230 CONTROL UNIT 55Ah 3P	3h	0	0	-	18 x (12 V 55 Ah)	3561	2849	471
	17635	9200	S230 CONTROL UNIT 70Ah 1P	1h	0	0	-	18 x (12 V 70 Ah)	11359	9087	601
	17636	5500	S230 CONTROL UNIT 70Ah 2P	2h	0	0	-	18 x (12 V 70 Ah)	6675	5340	601
	17637	4000	S230 CONTROL UNIT 70Ah 3P	3h	0	0	-	18 x (12 V 70 Ah)	4838	3870	601
	17638	10800	S230 CONTROL UNIT 80Ah 1P	1h	0	0	-	18 x (12 V 80 Ah)	13245	10596	631
	17639	6100	S230 CONTROL UNIT 80Ah 2P	2h	0	0	-	18 x (12 V 80 Ah)	7461	5969	631
17640	4400	S230 CONTROL UNIT 80Ah 3P	3h	0	0	-	18 x (12 V 80 Ah)	5370	4296	631	
17641	12800	S230 CONTROL UNIT 100Ah 1P	1h	0	0	-	18 x (12 V 100 Ah)	15673	12538	696	
17642	7400	S230 CONTROL UNIT 100Ah 2P	2h	0	0	-	18 x (12 V 100 Ah)	9006	7205	696	
17643	5400	S230 CONTROL UNIT 100Ah 3P	3h	0	0	-	18 x (12 V 100 Ah)	6549	5239	696	
17644	13800	S230 CONTROL UNIT 110Ah 1P	1h	0	0	-	18 x (12 V 110 Ah)	16903	13522	751	
17645	8000	S230 CONTROL UNIT 110Ah 2P	2h	0	0	-	18 x (12 V 110 Ah)	9854	7883	751	
17646	6000	S230 CONTROL UNIT 110Ah 3P	3h	0	0	-	18 x (12 V 110 Ah)	7191	5753	751	

* Modules expandable up to 13 slots - ** Built-in IN modules expandable up to 4 / External IN modules expandable up to 96 - *** 20° environment

ST24 LG230 CONTROL UNIT



The ST24 Control Unit (24 slots) is integrated into a metal cabinet that contains all system components. A second cabinet containing the battery pack is provided. Each Control Unit has a variable number of Output and Input Modules, depending on system requirements, max. 24 slots. Each output module is divided into 1, 2 or 4 lines, each capable of controlling up to 32 luminaires for a maximum of 1380W for 1x version, 690W for 2x version, 345W for 4x version each line.

The ST24 control unit has a 7" graphic touch screen display mounted on the door and output modules with 19" housings, the batteries are housed in a separate cabinet.

	Order Code	W	Description	Autonomy h	Modules OUT*	Modules IN**	Number of cabinets Battery	Battery	Power W		Weight Kg
									Nominal***	Max.	
LG230	17650	9200	ST24 S230 CONTROL UNIT 70Ah 1P	1	0	0	1	18 x (12 V 70 Ah)	11359	9087	783
	17651	5500	ST24 S230 CONTROL UNIT 70Ah 2P	2	0	0	1	18 x (12 V 70 Ah)	6675	5340	783
	17652	4000	ST24 S230 CONTROL UNIT 70Ah 3P	3	0	0	1	18 x (12 V 70 Ah)	4838	3870	783
	17653	10800	ST24 S230 CONTROL UNIT 80Ah 1P	1	0	0	1	18 x (12 V 80 Ah)	13245	10596	813
	17654	6100	ST24 S230 CONTROL UNIT 80Ah 2P	2	0	0	1	18 x (12 V 80 Ah)	7461	5969	813
	17655	4400	ST24 S230 CONTROL UNIT 80Ah 3P	3	0	0	1	18 x (12 V 80 Ah)	5370	4296	813
	17656	12800	ST24 S230 CONTROL UNIT 100Ah 1P	1	0	0	1	18 x (12 V 100 Ah)	15673	12538	878
	17657	7400	ST24 S230 CONTROL UNIT 100Ah 2P	2	0	0	1	18 x (12 V 100 Ah)	9006	7205	878
	17658	5400	ST24 S230 CONTROL UNIT 100Ah 3P	3	0	0	1	18 x (12 V 100 Ah)	6549	5239	878
	17659	13800	ST24 S230 CONTROL UNIT 110Ah 1P	1	0	0	1	18 x (12 V 110 Ah)	16903	13522	933
	17660	8000	ST24 S230 CONTROL UNIT 110Ah 2P	2	0	0	1	18 x (12 V 110 Ah)	9854	7883	933
	17661	5900	ST24 S230 CONTROL UNIT 110Ah 3P	3	0	0	1	18 x (12 V 110 Ah)	7191	5753	933
	17662	14800	ST24 S230 CONTROL UNIT 120Ah 1P	1	0	0	1	18 x (12 V 120 Ah)	18117	14494	1018
	17663	8600	ST24 S230 CONTROL UNIT 120Ah 2P	2	0	0	1	18 x (12 V 120 Ah)	10522	8418	1018
	17664	6300	ST24 S230 CONTROL UNIT 120Ah 3P	3	0	0	1	18 x (12 V 120 Ah)	7719	6175	1018
	17665	18900	ST24 S230 CONTROL UNIT 135Ah 1P	1	0	0	1	18 x (12 V 135 Ah)	23156	18525	1128
	17666	11100	ST24 S230 CONTROL UNIT 135Ah 2P	2	0	0	1	18 x (12 V 135 Ah)	13563	10850	1128
	17667	7900	ST24 S230 CONTROL UNIT 135Ah 3P	3	0	0	1	18 x (12 V 135 Ah)	9677	7742	1128
	17668	19400	ST24 S230 CONTROL UNIT 150Ah 1P	1	0	0	1	18 x (12 V 150 Ah)	23693	18954	1163
	17669	11200	ST24 S230 CONTROL UNIT 150Ah 2P	2	0	0	1	18 x (12 V 150 Ah)	13668	10934	1163
17670	8000	ST24 S230 CONTROL UNIT 150Ah 3P	3	0	0	1	18 x (12 V 150 Ah)	9819	7855	1163	
17671	24700	ST24 S230 CONTROL UNIT 200Ah 1P	1	0	0	2	18 x (12 V 200 Ah)	30243	24194	1694	
17672	14800	ST24 S230 CONTROL UNIT 200Ah 2P	2	0	0	2	18 x (12 V 200 Ah)	18101	14481	1694	
17673	10800	ST24 S230 CONTROL UNIT 200Ah 3P	3	0	0	2	18 x (12 V 200 Ah)	13225	10580	1694	
17674	29400	ST24 S230 CONTROL UNIT 230Ah 1P	1	0	0	2	18 x (12 V 230 Ah)	36059	28847	1844	
17675	17300	ST24 S230 CONTROL UNIT 230Ah 2P	2	0	0	2	18 x (12 V 230 Ah)	21228	16982	1844	
17676	12500	ST24 S230 CONTROL UNIT 230Ah 3P	3	0	0	2	18 x (12 V 230 Ah)	15225	12180	1844	

* Modules expandable up to 24 slots - ** Built-in IN modules expandable up to 8 / External IN modules expandable up to 96 - *** 20° environment

Logica 230

emergency

SUB-UNITS



ST8 LG230 SUB-UNIT

Each output module is divided into 1, 2 or 4 lines, each capable of controlling up to 32 luminaires for a maximum of 1380W for 1x version, 690W for 2x version, 345W for 4x version each line.

The ST8 sub-unit incorporates a 7" graphic touch screen display.

Order Code	Description	Modules OUT*	Modules IN**	Weight Kg
17680	ST8 S230 SUB-UNIT	0	0	35

* Modules expandable up to 8 slots - ** Built-in IN modules expandable up to 2 / External IN modules expandable up to 96

LG230

IP54

350x600x570mm



ST16 LG230 SUB-UNIT

Each output module is divided into 1, 2 or 4 lines, each capable of controlling up to 32 luminaires for a maximum of 1380W for 1x version, 690W for 2x version, 345W for 4x version each line.

The ST16 Sub-unit incorporates a 7" graphic touch screen display.

Order Code	Description	Modules OUT*	Modules IN**	Weight Kg
17681	ST16 S230 SUB-UNIT	0	0	66

* Modules expandable up to 16 slots - ** Built-in IN modules expandable up to 4 / External IN modules expandable up to 96

LG230

IP54

400x800x890mm



ST32 LG230 SUB-UNIT

Each output module is divided into 1, 2 or 4 lines, each capable of controlling up to 32 luminaires for a maximum of 1380W for 1x version, 690W for 2x version, 345W for 4x version each line.

The ST32 Sub-unit incorporates a 7" graphic touch screen display.

Order Code	Description	Modules OUT*	Modules IN**	Weight Kg
17682	ST32 S230 SUB-UNIT	0	0	163

* Modules expandable up to 32 slots - ** Built-in IN modules expandable up to 8 / External IN modules expandable up to 96

LG230

IP54

600x800x2000mm



S24 LG24 SUB-UNIT

Multi-purpose sub-unit for the LG24 system, but it can also be connected to an LG230 Control Unit. Each output module is divided into 1, 2 or 4 lines, each capable of controlling up to 32 x 24V luminaires.

The S24 Sub-unit incorporates a 7" graphic touch screen display.

Order Code	Description	Modules OUT	Modules IN*	Weight Kg
17064	S24 SUB-UNIT	1 (4x32)	-	16

* External IN modules expandable up to 96

LG24

IP20

400x316x144mm

SYSTEM COMPONENTS



LG230 DRM MODULE

The DRM module recharges a new generation LiTO (Lithium titanate battery) with a very long life, when the system is in normal operation.

In the event of a disaster that cuts the power cables (e.g., an earthquake), the battery, via the DRM module, provides the lamp with the energy to switch on the emergency light



Order Code	Description	Battery	Autonomy h	Recharging time h	LED lm*	Weight Kg
17236	DRM S230 MODULE + 1 LTO BATTERY	LTO 4.8V 0.5 Ah	1.5	7	110	
RA09	ADDITIONAL LTO BATTERY	LTO 4.8V 0.5 Ah	3	14	-	



EXTERNAL OUTPUT MODULE

The external output modules are integrated in a plastic cabinet that contains all system components, has a control panel with a large display, and cable entry from above.

Output module: 2 or 4 lines for max. 32 luminaires per line, permanent or non-permanent mode on the same line, power per line: 400W max., voltage/current per line: 230 V / 1.75A)

Order Code	W	Description	Modules OUT*	No. of luminaires Connectable	Weight Kg
17685	400	S230 2X32 EXT. OUTPUT MODULE	1(2x32)	64	37
17686	2X400	S230 2+2X32 EXT. OUTPUT MODULE	2 (2x32)	128	40

* Number of output modules supplied 2x32 (300W max. per line)



LG230 - LG24 INPUT MODULES

Ordinary mains monitoring module. It allows a selective activation of parts of the system.

8 inputs - Relay output - DIN module mounting

LG230 module: 230V mains check on inputs
Three-phase sensor on inputs 1,2,3

LG24 module: Check of isolated changeover contacts

Order Code	Description	Weight Kg
17230	S230 S24 230V DIN INPUT MODULE	0.2
17231	S230 S24 24V DIN INPUT MODULE	0.2

NEXT >

Logica 230

emergency

SYSTEM COMPONENTS



LG230

IP20

152x32x24mm

LG230 6-12W LED INVERTER

Inverter module for LED luminaires, consisting of two parts, the Driver LED 12W Sicuro 230V and the Switch Module INV Sicuro 230V

- Driver output voltage from 2 to 55V.
- Management of LED emergency luminaires
- Housing material: polycarbonate

Order Code	Description	Weight Kg
17381	230V 12W LOGICA INVERTER	0.1



LG230

IP20

152x32x24mm

2.5-500W LAMP MODULE

Lamp monitoring and control module.

- Permanent mode (SA), non-permanent mode (SE).
- Switching on and off via local switch.
- Load: 2.5 W - 500 W
- Operating voltage: 198 - 254Vca / 50Hz
- Battery operating voltage: 176÷276VDC
- Housing material: polycarbonate
- Protection rating: II
- Maximum output inrush load: 50A per 250µs (3J)

Order Code	Description	Weight Kg
17382	SWITCH 500W LOGICA 230V	0.1



LG230

IP20

152x32x24mm

DALI LAMP MODULE

Module for the management of luminaires for lighting and emergency lighting, equipped with a DALI electronic power supply unit, with anomaly reports.

- Individual monitoring with selective anomaly report
- SE or SA mode programmable from the Control Unit from the local LSSA or LSSA input module
- Selectable emergency lamp luminous flux
- Load: 2.5-4 W
- Operating voltage: 198Vca - 254Vca / 50 Hz
- Battery operating voltage: 176 VDC - 254VDC
- Housing material: polycarbonate

Order Code	Description	Weight Kg
17383	SWITCH LOGICA 230V DALI	0.1

ACCESSORY



LG230 OUTPUT MODULE
 Piloting of 1, 2 or 4 lines per luminaire. Each line can supply a load of 1380W for 1x version, 690W for 2x version, 345W for 4x version. Max. 32 luminaires per line.
 Order Code **17232** (2X32)
 Order Code **17233** (1X32) - Order Code **17234** (4X32)



WALL-MOUNTED REMOTE PANEL
 Operation mode control for both LG230 and LG24 systems
 Order Code **17207**



NETWORK SENSOR
 Mains power monitoring module for normal lighting, activation of the output control in the event of a failure on the mains: $U < 0.6 U_N$ per 0.5 s.
 DS3 - UV 1-3 PHASE MONITORING
 Order Code **17385**
 Order Code **17206N**
 Order Code **17226**



RECESSED REMOTE PANEL
 Operation mode control for both LG230 and LG24 systems
 Order Code **17208**



REMOTE TOUCH SCREEN PANEL
 Control of up to 63 control units with multiple functions. It integrates a 7" graphic touch screen display
 Order Code **17240**



USB/RS485 CONVERTER
 Connection interface from PC to LG control units
 Order Code **17235**



BATTERY CONTROLLER
 Kit for 18 batteries
 Order Code **17384**



LS-UV MODULE
 Order Code **17237**

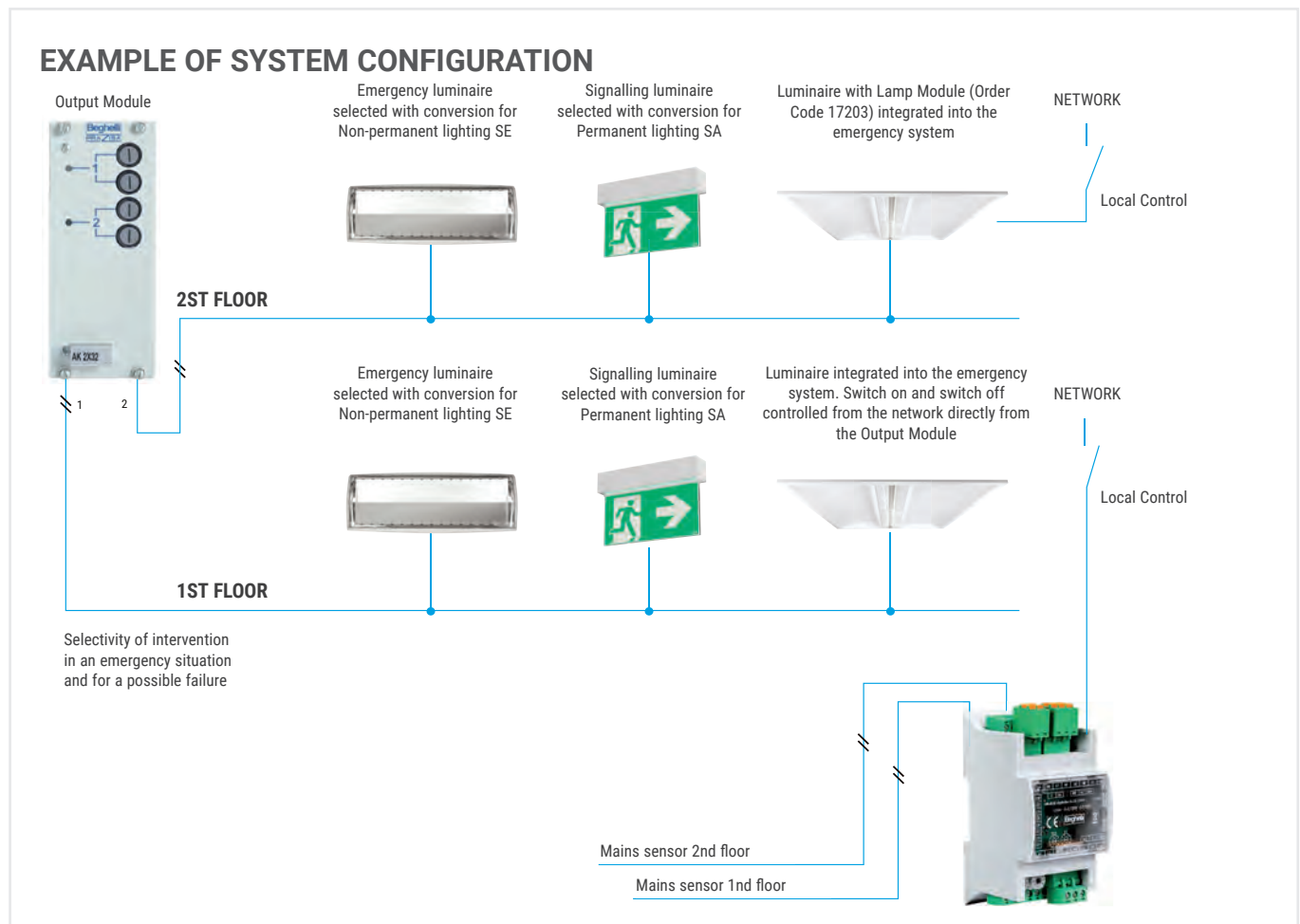

All the configurations shown in the diagram can be programmed simply from the control unit, without any changes to the system, using only the lamp power supply line, and can be reconfigured according to changing system requirements.

Logica 24

emergency



A centralised power supply system that enables the management of emergency lighting and signalling lamps using a safety extra-low voltage. Diagnostic functions with automatic function and autonomy tests. According to DIN EN 50172, the system's protection rating is class III. During emergency operation, a continuous 24VDC voltage is supplied. Each luminaire is assigned a specific unique address in self-learning. LOGICA 24 can also be integrated into a BMS (Building Management System) with the appropriate software.



By inserting the specific LED inverter, ordinary luminaires can be integrated into the emergency lighting system.

Compliance EN50171, 2014/30/EU, 2014/35/EU, EN50172, EN62040-1-1, EN62040-2

CONTROL UNITS

The LG24 Control Unit is available in 2 standard configurations that vary according to the number of lines (4 lines, 8 lines). Each control unit is with an adjustable autonomy from 1 h to 3 hrs, with decreasing powers.

LG24 CONTROL UNITS



FUNCTIONS

- Possibility of controlling and monitoring emergency luminaires on the same line, but with different operating modes:
 - SA functions: conversion of selected luminaires in permanent mode
 - For SA luminaires, 10-100% dimmer function;
 - SE function: conversion of selected luminaires to non-permanent mode
- Non-permanent mode with selective activation of the emergency function by external input modules in the event of a partial failure on the mains
- Automatic recognition of control lines and modules for the installed luminaires
- Individual monitoring of 32 luminaires per line
- Automatic execution of functional and autonomy tests
- Automatic reporting of tests performed.
- Event logging for two years (LOG-BOOK)

INNOVATIONS IN THE LOGICA 24 SYSTEM

- Reduction in the number of circuits and wiring
- Reduction of the size of the control panel
- Reduction of installation costs
- Design simplification
- Increased flexibility both during and after installation
- Each module and each lamp is equipped with an identification code. No manual addressing required
- The LOGICA 24 system does not require incorrect or double addressing control. As a result, any time frame for solving a problem is eliminated

SYSTEM SPLITTING

The LG24 system is particularly suitable for situations where splitting up the emergency system is advantageous. Each control unit is connected to a PC for supervision which, in turn, can be connected in the cloud with the NuBe Beghelli web portal.

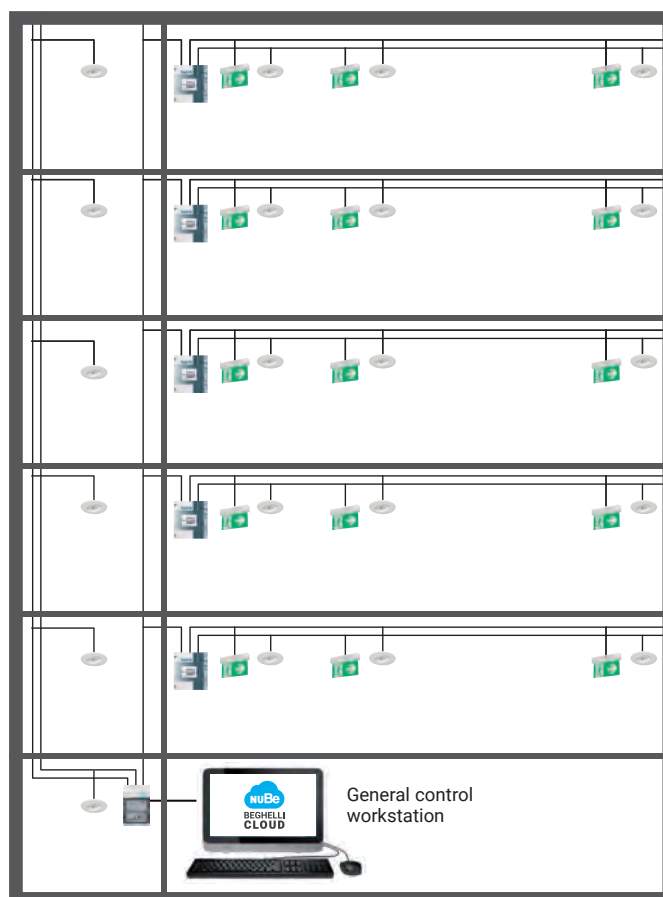

24V LOW-VOLTAGE OUTPUT MODULE



- Selective activation of the emergency function with emergency luminaires via the LOGICA 24 monitoring and control module
- Activation of the emergency function with normal lighting luminaires via the Inverter LOGICA 24 monitoring and control module
- Automatic addressing of the LOGICA 24 and Inverter LOGICA 24 modules via the ID code
- Permanent or non-permanent mode programmable per each luminaire
- Permanent or non-permanent mode on the same line
- Selective dimming (10 - 100%) per each luminaire in the permanent mode
- Selective switching (ON/OFF) per each luminaire in the permanent mode
- Selective switching (ON/OFF) per each luminaire in the non-permanent mode
- Self-diagnosis of all luminaires in a circuit with error indication for each luminaire

Logica 24

emergency

CENTRALISED LOW-VOLTAGE SYSTEMS

LOGICA 230/24 is a centralised power supply for emergency lighting with diagnostic functions and automatic functional and autonomy tests. The great versatility of the system allows composing a mixed system consisting of 230V modules and 24V modules using LOGICA 230 and LOGICA 24 also in dynamic mode. In addition, it is possible to connect luminaires already used for ordinary lighting as emergency luminaires, by simply inserting the specific Lamp Module, and it is always possible to integrate LOGICA 230/24 into a BMS system (Building Management System). Each luminaire can carry out the diagnostics required by the

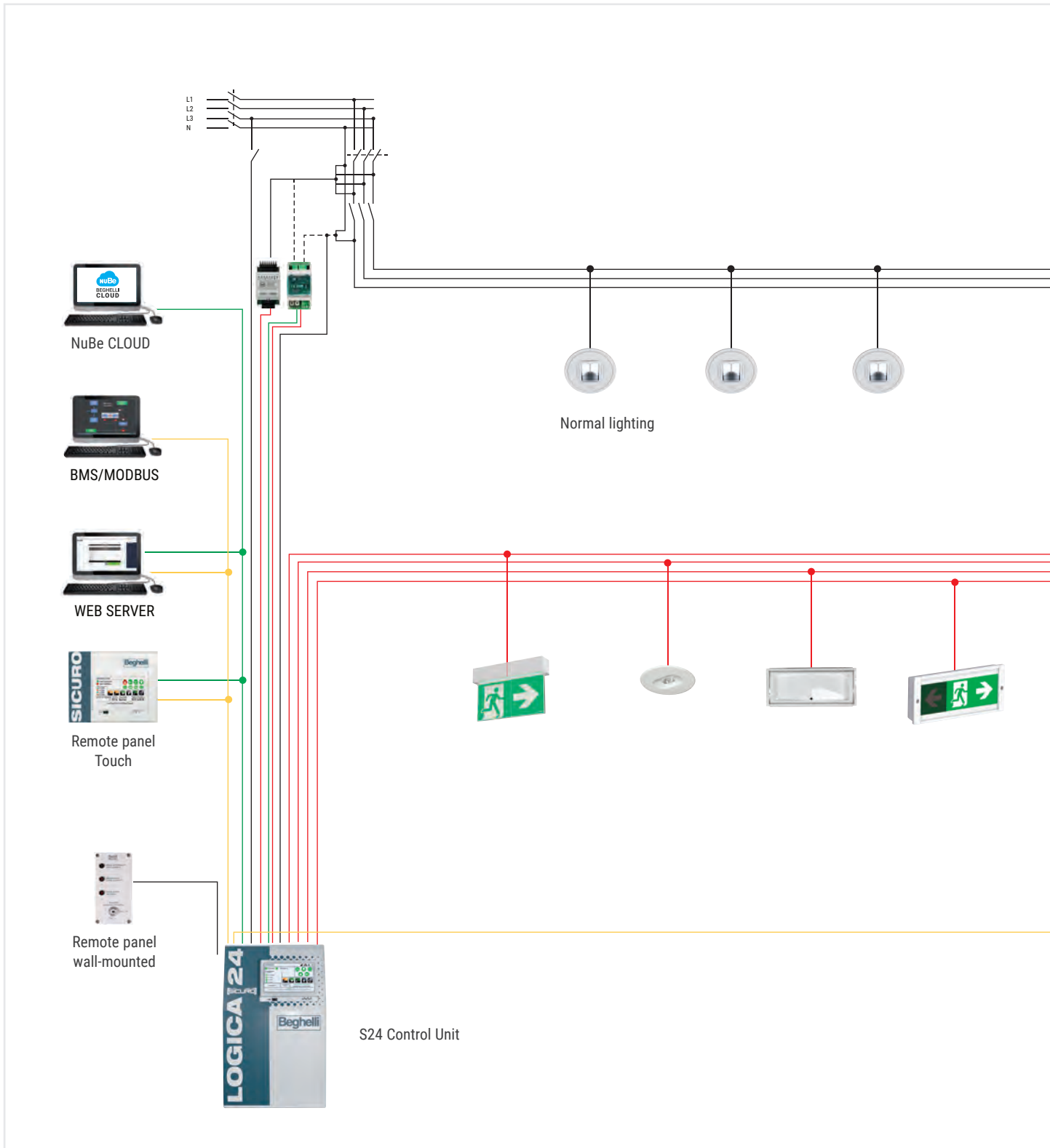

UNI 11222 standard, by communicating individually with the control unit using the power supply lines for information exchange by means of the power-line communication technology: the Control Unit sends an encoded digital transmission on the power supply lines dedicated to the luminaires, which transmission is only received by the luminaire to which it is addressed. This technology limits the number of connections and installation cables with obvious savings in material and labour.

MAXIMUM CABLE LENGTH FOR A MAXIMUM VOLTAGE DROP OF 3.5V		
Load (A)	Cross-section (mm ²)	Length (m)
3	1.5	49
2	1.5	74
1	1.5	147
3	2.5	82
2	2.5	123
1	2.5	245

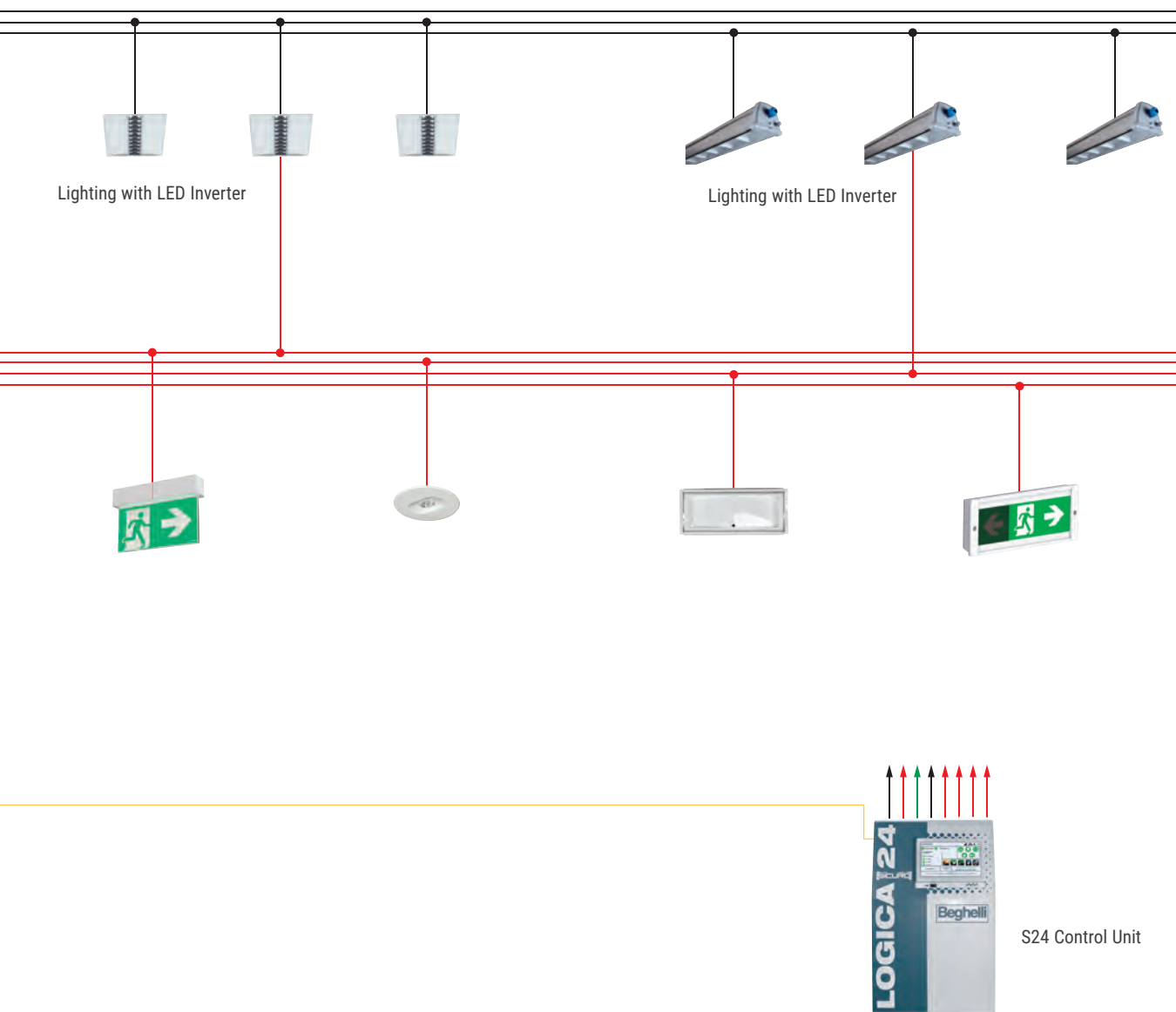

Logica 24

emergency

LG24 CONTROL UNIT - 4 LINES



LOGICA 24 Control Unit with 4 output circuits integrated into a metal cabinet that contains all system components and battery packs. Each output circuit can control up to 32 luminaires. Luminaire monitoring performs a functional test of the system and an endurance test to assess autonomy in case of emergency. Test results are stored in the control unit and can be shared. All LG24 control units feature a 7" colour touch screen display, the batteries are housed directly in the lower part of the control unit cabinet.

LG24

IP20

+35°C
-5°C

316x515x140mm (17060)
316x636x140mm (17061)
400x800x170mm (17062/63/65/66)

	Order Code	Description	Power / Autonomy			Battery		Output circuits	Maximum current	Colour RAL	Weight Kg	CENTRALISED BATT.
			1h	2h	3h	Total capacity	Number and Type					
LG24	17060	LGS24 4U 12Ah B	156W	88.8W	67.2W	12Ah	2x 12V 12Ah	4	3A	9003	15	
	17061	LGS24 4U 24Ah B	288W	180.8W	134.4W	24Ah	4x 12V 12Ah	4	3A	9003	25.7	
	17062	LGS24 4U 28Ah G	288W	232.8W	170W	28Ah	2x 12V 28Ah	4	3A	7035	37.5	
	17063	LGS24 4U 56Ah G	288W	288W	288W	56Ah	4x 12V 28Ah	4	3A	7035	56.5	

External IN modules expandable up to 96

LG24 CONTROL UNIT - 8 LINES



LOGICA 24 Control Unit with 8 output circuits integrated into a metal cabinet that contains all system components and battery packs. Each output circuit can control up to 32 luminaires. Luminaire monitoring performs a functional test of the system and an endurance test to assess autonomy in case of emergency. Test results are stored in the control unit and can be shared. All LG24 control units feature a 7" colour touch screen display, the batteries are housed directly in the lower part of the control unit cabinet.

LG24

IP20

+35°C
-5°C

400x800x170mm

	Order Code	Description	Power / Autonomy			Battery		Output circuits	Maximum current	Colour RAL	Weight Kg	CENTRALISED BATT.
			1h	2h	3h	Total capacity	Number and Type					
LG24	17065	LGS24 8U 28Ah G	384W	233W	170W	28Ah	2x 12V 28Ah	8	3A	7035	39.5	
	17066	LGS24 8U 56Ah G	384W	384W	334W	56Ah	4x 12V 28Ah	8	3A	7035	58.5	

External IN modules expandable up to 96

LG24 EXTREME CONTROL UNIT - 4 LINES



LOGICA 24 Control Unit with 4 output circuits integrated into a metal cabinet that contains all system components and battery packs. Each output circuit can control up to 32 luminaires.

Luminaire monitoring performs a functional test of the system and an endurance test to assess autonomy in case of emergency. Test results are stored in the control unit and can be shared. All LG24 control units feature a 7" colour touch screen display, the batteries are housed directly in the lower part of the control unit cabinet. LTO (Lithium Titanium) batteries guarantee high performance and reliability and can be used in extreme temperatures: -20°C +50°C.

	Order Code	Description	Power / Autonomy			Battery		Output circuits	Maximum current	Colour RAL	Weight Kg
			1h	2h	3h	Total capacity	Number and Type				
LG24	17075	LGS24 4U EXTREME LTO 20Ah	226W	130W	94W	20Ah	1x 12V 20Ah	4	3A	7035	33
	17076	LGS24 4U EXTREME LTO 40Ah	288W	288W	230W	40Ah	2x 12V 20Ah	4	3A	7035	39

CENTRALISED BATT.

External IN modules expandable up to 96

LG24 EXTREME CONTROL UNIT - 8 LINES

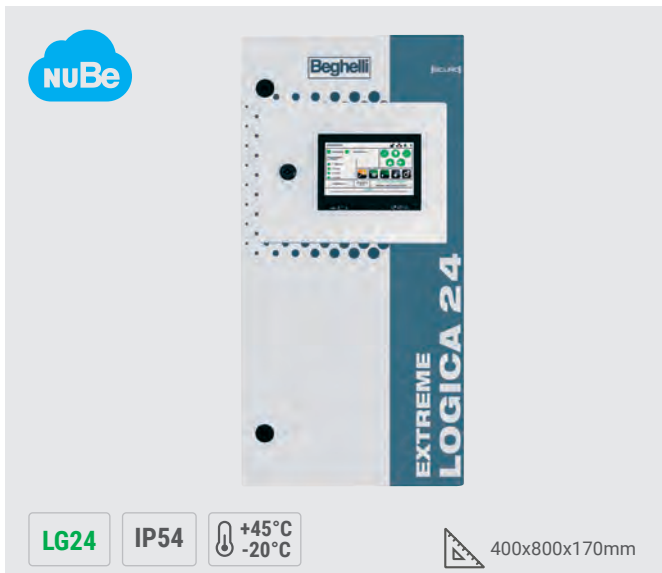

LOGICA 24 Control Unit with 8 output circuits integrated into a metal cabinet that contains all system components and battery packs. Each output circuit can control up to 32 luminaires.

Luminaire monitoring performs a functional test of the system and an endurance test to assess autonomy in case of emergency. Test results are stored in the control unit and can be shared. All LG24 control units feature a 7" colour touch screen display, the batteries are housed directly in the lower part of the control unit cabinet. LTO (Lithium Titanium) batteries guarantee high performance and reliability and can be used in extreme temperatures: -20°C +50°C.

	Order Code	Description	Power / Autonomy			Battery		Circuits power	Maximum current	Colour RAL	Weight Kg
			1h	2h	3h	Total capacity	Number and Type				
LG24	17077	LGS24 8U EXTREME LTO 20Ah	283W	130W	94W	20Ah	1x 12V 20Ah	8	3A	7035	35
	17078	LGS24 8U EXTREME LTO 40Ah	384W	319W	230W	40Ah	2x 12V 20Ah	8	3A	7035	41

CENTRALISED BATT.

External IN modules expandable up to 96

NEXT >

Logica 24

emergency

SYSTEM COMPONENTS



LG230

LG24

110x54x60mm

LG24 INPUT MODULES

Ordinary mains monitoring module. It allows a selective activation of parts of the system.

8 inputs - Relay output - DIN module mounting

LG230 module: 230V mains check on inputs

Three-phase sensor on inputs 1,2,3

LG24 module: Check of isolated changeover contacts

Order Code	Description	Weight Kg
17230	S230 S24 230V DIN INPUT MODULE	0.2
17231	S230 S24 24V DIN INPUT MODULE	0.2



LG24

239x46x30mm (17220)
301x139x55mm (17210)

LG24 6-12W LED INVERTER

Module with plastic housing for installation inside LED luminaires with the Driver output voltage from 2 to 55V. It allows the management of LED emergency luminaires.

Order Code	Description	Protection rating	Weight Kg
17210	INV LED IP65 LOGICA 24V	IP65	0.8
17220	INV LED SLGS LOGICA 24V	IP40	0.1

ACCESSORY



NETWORK SENSOR

Mains power monitoring module for normal lighting, activation of the output control in the event of a failure on the mains: $U < 0.6 \text{ UN}$ per 0.5 s.
DS3 - UV 1-3 PHASE MONITORING

Order Code **17385**
Order Code **17206N**
Order Code **17226**



WALL-MOUNTED REMOTE PANEL

Operation mode control for both LG230 and LG24 systems

Order Code **17207**



REMOTE TOUCH SCREEN PANEL

Control of up to 63 control units with multiple functions. It integrates a 7" graphic touch screen display

Order Code **17240**



RECESSED REMOTE PANEL

Operation mode control for both LG230 and LG24 systems

Order Code **17208**

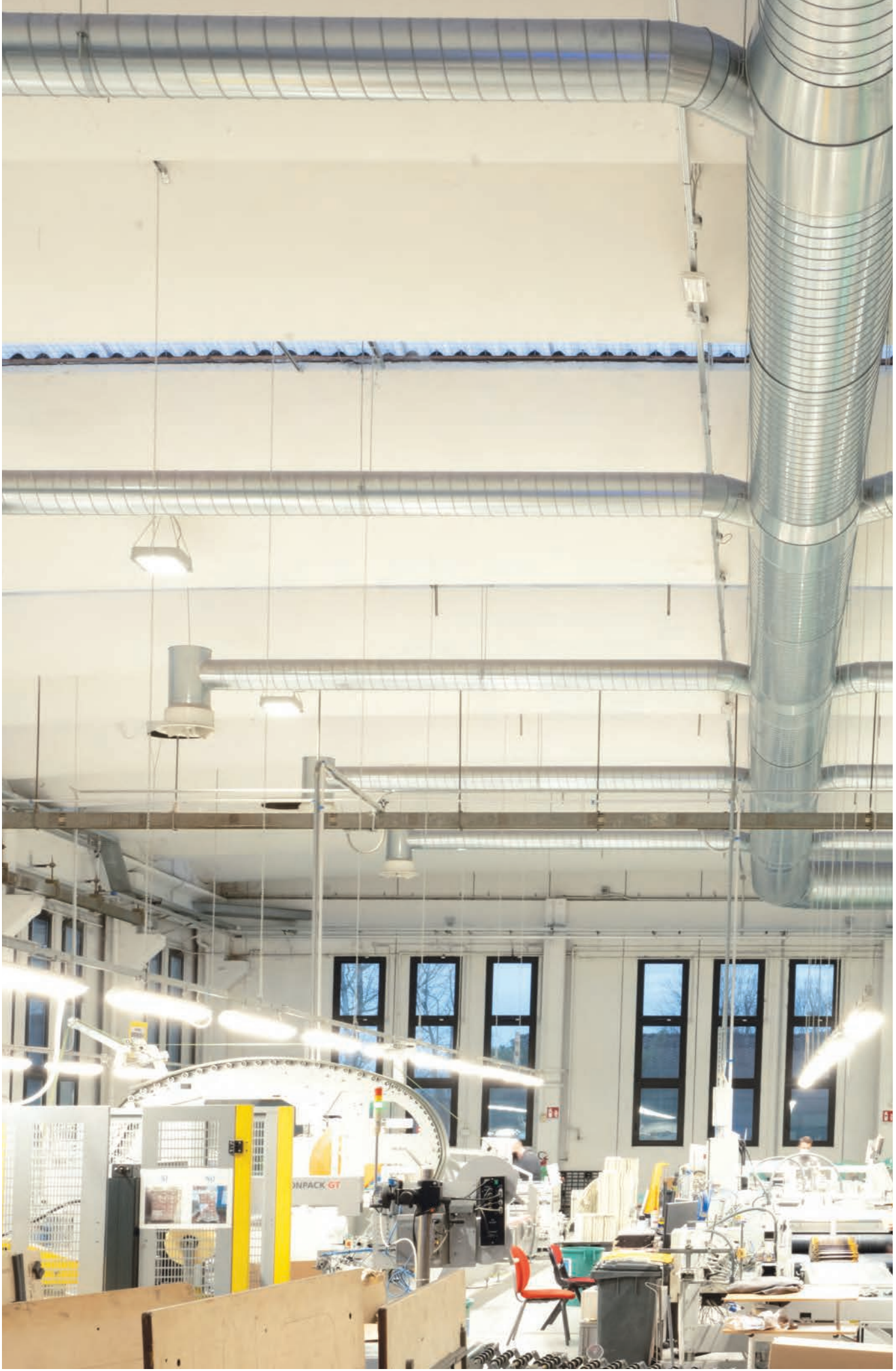

127 centralised battery systems

Logica 24 Dynamic

emergency



Rescue and safety signs are designed to illuminate the safe place outside the building or towards the assembly points, indicating the shortest route even in the event of power failures. In the event of fire, however, escape routes may be obstructed by smoke or fire. Only a dynamic emergency system can take into account these situations, visually blocking unusable escape routes and showing safe alternatives. People's lives, as a top priority, thanks to a system that contributes to the safe evacuation of buildings.



The dynamic system can be integrated into any system with LG24 or LG24 Extreme control units, interfacing the system, for example, with the fire fighting system.

EVOLVING SAFETY REGULATIONS

Dynamic safety signalling systems are part of an evolving regulatory framework which, starting from the cornerstones of safety signalling at the workplace, regulated in general terms by Legislative Decree 81/08 and in particular terms by specific "Vertical" rules, is developing through the most modern principles set out in Ministerial Decree of 03 August 2015 (Approval of technical standards for fire prevention).

This provision explicitly refers to the responsibilities of the persons in charge of the best coordination of escape routes and their functions (ref. S.4.5.3, 4.5.8, 4.8.4).

LG24 CONTROL UNITS



LG24 DYNAMIC LUMINAIRES



DYNAMIC SIGNAGE OF ESCAPE ROUTES FOR SAFE EVACUATION

The LOGICA 24 system makes it possible to increase the safety of workplaces, in particular complex places with more than one escape route, by managing conflict situations, the unavailability of escape routes for emergency situations (smoke or something else that prevents evacuation through that escape route).

The system is also particularly suitable in crowded places where bystanders are unfamiliar with the location. In these situations, it has been experimentally demonstrated that, in a situation of emergency, people are directed to leave the place by going back on the route they used to get there. By capturing the attention of bystanders to a greater extent and providing additional information in addition to the direction of escape, Variable and Dynamic signalling reduces these potentially

dangerous situations.

The LOGICA 24 Dynamic System is an evolution of the LOGICA 24 System, with which it shares the control units and various interface devices. The system is connected to the building's fire fighting system via the potential-free contacts of the S24 input modules. If one or more smoke sensors send(s) a signal, the fire fighting control unit will trigger a change of status of the inputs and of the preset signalling scenarios. The emergency signalling scenarios, which are automatically activated in the event of a fire, indicate escape routes that are not at risk and activate the change of direction on the luminaires, or they block access to areas at risk with the illumination of safety signs prohibiting access.

A DYNAMIC SYSTEM IS BASED ON TWO FUNDAMENTAL PRINCIPLES:

1. prevent people from taking dangerous smoke-saturated escape routes
2. enable people in areas already saturated with smoke to take safer escape routes.

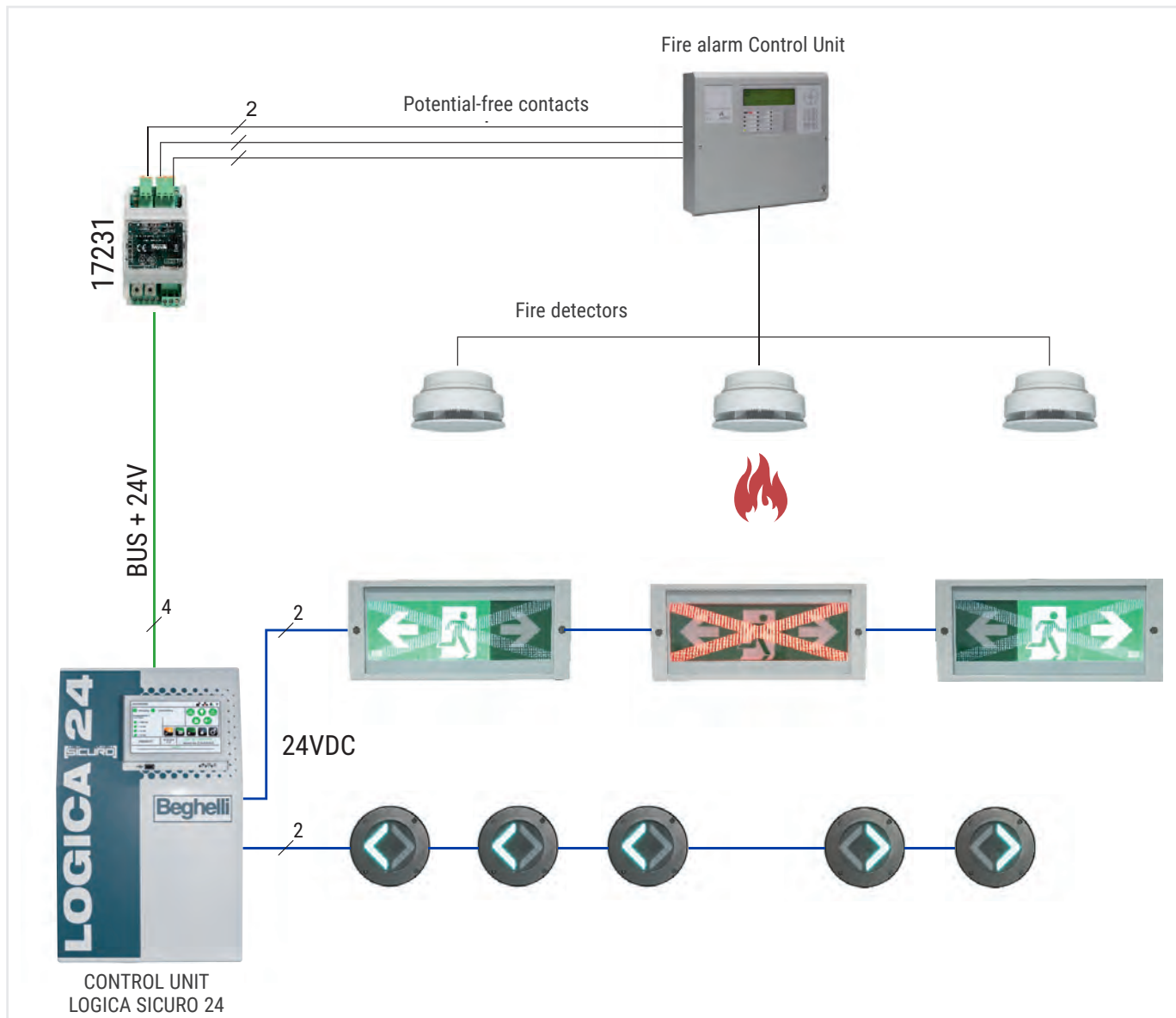

Logica 24 Dynamic

emergency

SYSTEM WITH LG24 DYNAMIC SYSTEM IN STATIC MODE

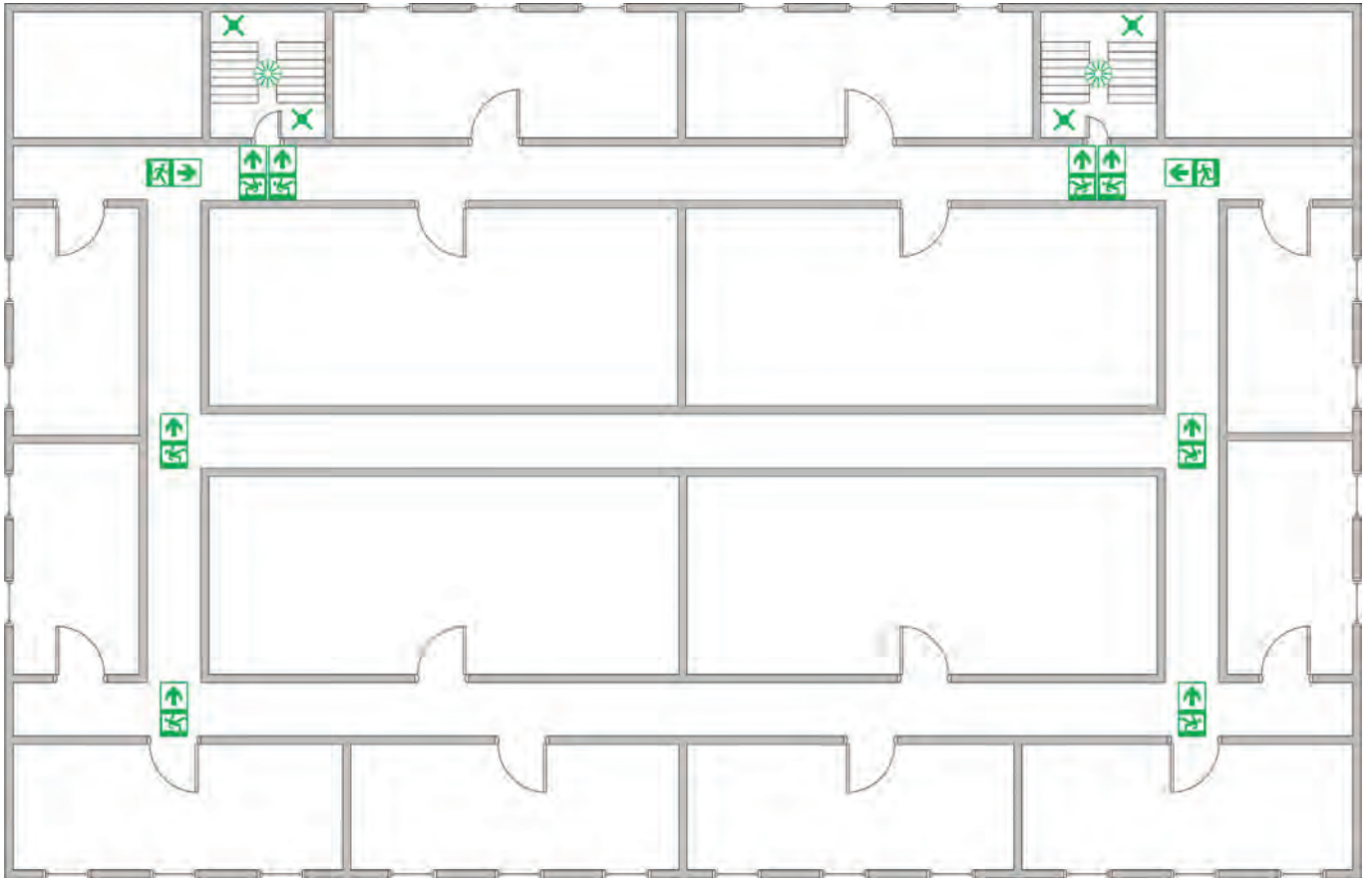

SYSTEM WITH LG24 DYNAMIC SYSTEM IN DYNAMIC MODE

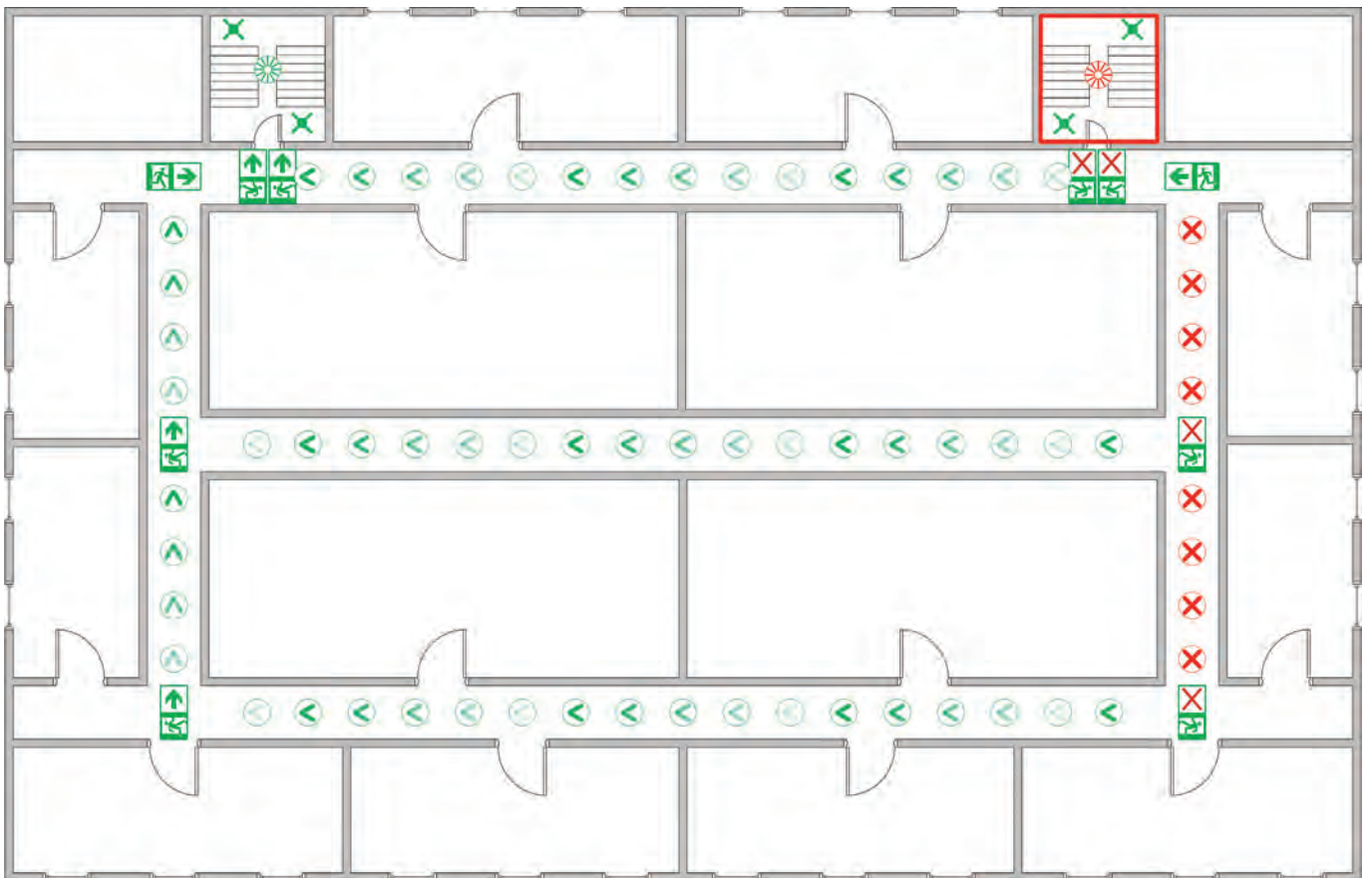

FIRE EXIT SIGN



Dynamic emergency luminaire for exiting high-risk areas. The connection with the LG24 Control Unit, which interfaces with the sensors of the fire fighting system, makes it possible to determine the escape route with the lowest risk index in the event of smoke or fire. This luminaire makes it possible to drastically reduce the risk to people during emergency escape in the event of a fire.

LG24

IP65



392x175x60mm



DANGER SITUATION ON THE RIGHT
The LG24 Dynamic system **indicates** the escape route to the left



DANGEROUS SITUATION ON THE LEFT
The LG24 Dynamic system **indicates** the escape route to the right



SERIOUS DANGER SITUATION
The LG24 Dynamic system **blocks** access to hazardous areas.

	Order Code	W eq.	Description	DC power input W	Weight Kg	Packaging
LG24	34000	24	LGS24 DYNAMIC FIRE EXIT SIGN	2.8	2.8	6

FIRE EXIT STEP SIGN



Dynamic emergency luminaire for exiting high-risk areas. The connection with the LG24 Control Unit, which is interfaced with the sensors of the fire fighting system, makes it possible to determine the escape route with the lowest risk index. This luminaire, which drastically reduces the risk to people in the event of a fire, can be installed on the ground, even where great strength is required, such as tunnels or basements. Its positioning makes it possible to detect the output signal even when the smoke does not allow the signals above to be seen.

LG24

IP65



Ø140, Ø90, H120mm



	Order Code	W eq.	Description	DC power input W	Weight Kg	Packaging
LG24	34002	24	LGS24 DYNAMIC FIRE EXIT STEP SIGN	1.6	1.1	6

Emergency power supply units

emergency



IP21

+40°C
-0°C



SOCC.CA SE/SA emergency power supply units are characterised by a high input power factor, high efficiency and reliability, and are supplied with two outputs: SA, to supply a permanent load, and SE supplied only in the event of a failure on the mains. In the event of a blackout, voltage will be supplied to both outputs by the inverter drawing current from the battery pack. If the mains voltage repeatedly goes out of specification (3 times in 2 minutes) the emergency power supply unit will work as a UPS until the mains returns to normal for at least 30 minutes; this ensures power quality to the load.

The emergency power supply units are equipped with LCD displays and monitoring software.



Wide range to meet all requirements with powers available from 1000VA to 10kVA. The battery packs are contained in external pieces of furniture and can be composed to achieve the desired autonomy.

BOX FOR HOUSING EXTERNAL BATTERY PACKS

Line equipped with an external battery pack housed in a matt black powder-coated sheet metal box with a design coordinated with the control unit of the emergency power supply unit. Access to the batteries is provided by tilting doors with air intakes designed for cooling. The Box is available in 3 sizes to meet all system requirements.



Order Code	Dimensions of the emergency power supply unit mm			Box dimensions mm		
	L	B	H	L	B	H
17700,17701	145	400	220	450	450	610
17702	145	400	220	780	450	610
17703	192	460	347	450	450	610
17704,17705, 17706, 17707, 17708	192	460	347	780	450	610
17709, 17710, 17711, 17712, 17713, 17714, 17715, 17716, 17717, 17718, 17719, 17720	260	550	708	950	470	1190































	1KVA	2KVA	3KVA	4KVA	6KVA	8KVA	10KVA
VA/W	1000/800	2000/1600	3000/2400	4000/3600	6000/5400	8000/7200	10000/9000
PHASE	Single-phase + earth						
VOLTAGE	178~275VAC						
FREQUENCY	46~54Hz / 56~64Hz						
POWER FACTOR	≥0.98						
CONNECTION	Three-pole mains cable with Schuko plug			Terminal block			
VOLTAGE	208/220/230/240VAC ±2%						
WAVE FORM	Sinusoidal						
HARMONIC DISTORTION	THD<5%						
FREQUENCY	46~54Hz / 56~64Hz Synchronised						
	50/60 ±0.1Hz from the battery						
CREST FACTOR	3:1 max						
CONNECTION	1 Schuko (SA output) Schuko (SE output)	2 Schuko + Terminal block (SA output) Schuko (SE output)	2 Schuko + Terminal block (SA output) Schuko (SE output)	Terminal block			
NO NETWORK	<20ms						
INVERTER	<20ms						
FROM THE NETWORK	87% - 89%						
FROM THE BATTERY	81% - 84% - 86%						
TYPE	12V sealed Pb						
NUMBER	Depending on model*						
AUTONOMY	Depends on battery						
LOAD	Depends on battery						
FROM THE NETWORK	60s @ 100%~130%						
FROM THE BATTERY	10s @ 100%~130%						
NOISE	<50dB @ 1m						

	Order Code	Description	Power VA	Active power W	Power according to the EN50171 standard W	Battery	No. of batteries	Autonomy h
HT230	17700	SOCC.CA SE/SA 1KVA 1P 1ELM	1000	800	670	PB 12V 55Ah	3	1
	17701	SOCC.CA SE/SA 1KVA 2P 1ELM	1000	800	670	PB 12V 85Ah	3	2
	17702	SOCC.CA SE/SA 1KVA 3P 1ELM	1000	800	670	PB 12V 120Ah	3	3
	17703	SOCC.CA SE/SA 2KVA 1P 1ELM	2000	1600	1300	PB 12V 33Ah	8	1
	17704	SOCC.CA SE/SA 2KVA 2P 1ELM	2000	1600	1300	PB 12V 55Ah	8	2
	17705	SOCC.CA SE/SA 2KVA 3P 1ELM	2000	1600	1300	PB 12V75Ah	8	3
	17706	SOCC.CA SE/SA 3KVA 1P 1ELM	3000	2400	2000	PB 12V 55Ah	8	1
	17707	SOCC.CA SE/SA 3KVA 2P 1ELM	3000	2400	2000	PB 12V 80Ah	8	2
	17708	SOCC.CA SE/SA 3KVA 3P 1ELM	3000	2400	2000	PB 12V 120Ah	8	3
	17709	SOCC.CA SE/SA 4KVA 1P 1ELM	4000	3600	3000	PB 12V 28Ah	20	1
	17710	SOCC.CA SE/SA 4KVA 2P 1ELM	4000	3600	3000	PB 12V 55Ah	20	2
	17711	SOCC.CA SE/SA 4KVA 3P 1ELM	4000	3600	3000	PB 12V 70Ah	20	3
	17712	SOCC.CA SE/SA 6KVA 1P 1ELM	6000	4800	4000	PB 12V 40Ah	20	1
	17713	SOCC.CA SE/SA 6KVA 2P 1ELM	6000	4800	4000	PB 12V 70Ah	20	2
	17714	SOCC.CA SE/SA 6KVA 3P 1ELM	6000	4800	4000	PB 12V 100Ah	20	3
	17715	SOCC.CA SE/SA 8KVA 1P 1ELM	8000	6600	5500	PB 12V 55Ah	20	1
	17716	SOCC.CA SE/SA 8KVA 2P 1ELM	8000	6600	5500	PB 12V 85Ah	20	2
	17717	SOCC.CA SE/SA 8KVA 3P 1ELM	8000	6600	5500	PB 12V 134Ah	20	3
	17718	SOCC.CA SE/SA 10KVA 1P 1ELM	10000	8400	7000	PB 12V 70Ah	20	1
	17719	SOCC.CA SE/SA 10KVA 2P 1ELM	10000	8400	7000	PB 12V 120Ah	20	2
17720	SOCC.CA SE/SA 10KVA 3P 2ELM	10000	8400	7000	PB 12V 80Ah	2x20*	3	

* 2 BOXES per battery pack

Key to symbols

GENERAL CHARACTERISTICS: MEANING OF SYMBOLS

SYMBOL	DESCRIPTION	SYMBOL	DESCRIPTION
	Single cloud platform for the remote management of all lighting and emergency lighting systems.		Hybrid emergency lighting luminaires from the SanificaAria series, incorporating a UV-C flow cell air sanitisation system.
	Control Unit or Luminaire manageable directly by from the B.connect APP: it enables optical communications to the luminaire and local WiFi connections to the control unit. It also allows direct access to the nuBe cloud platform.		Luminaires from the ArchiEco series, an emergency range with a particularly evolved design, intended for the world of lighting designers and made from entirely renewable and compostable raw materials.
	Device for enabling the Rest Mode function on emergency luminaires		General description defining the type of luminaire.
	Emergency fixtures for non-permanent lighting		Luminaires with special features for versatility of use.
	Emergency fixtures for permanent lighting		Luminaires with special lighting characteristics. High luminous flux and beam control.
	Self-contained luminaires without diagnostics.		Luminaires with special mounting solutions, in terms of installation speed and/or multiple connections or through-wiring.
	Self-contained luminaires with local diagnostics, AutoTest series.		Luminaires with a motion sensor for automatic lighting activation.
	Self-contained luminaires with local AutoTest diagnostics and Opticom optical programming technology. Using the Beghelli Opticom APP, which can be downloaded from the various stores, it is possible to control and program the luminaires. By integrating the corresponding LG or LGFM modules, the luminaire switches from local Autotest (AT) diagnostics to centralised CentralTest diagnostics.		Luminaires suitable for architectural applications, with a surface treatment that allows them to be painted with normal wall paints.
	Self-contained luminaires with local AutoTest diagnostics prepared for expansion into CentralTest central diagnostics, with only the integration of the Cablecom (CBL) control unit into the system, without additional modifications. As soon as it is power supplied, the CBL Control Unit automatically connects with and takes control over the AT-CBL luminaires.		Laser module for projecting safety signs on the ground. The optional device can be integrated into certain prepared luminaires (DOT, IRON FLAG)
	Self-contained luminaires with centralised diagnostics via BUS Logica (LG). If the LG Control Unit is not present, the luminaires are configured in AT mode.		Protection rating against external factors according to EN 60598-1. If it is double, highlight two versions of the luminaire or a specific optional accessory.
	Self-contained luminaires with centralised radio diagnostics and remote control from an LGFM Control Unit. If the Control Unit is not present, the luminaires are configured in AT mode.		Protection rating against impact according to EN 50102.
	Emergency luminaires interfaced with DALI communication BUS.		Resistance temperature of the luminaire at the Glow Wire Test according to IEC EN 60598-1.
	Emergency luminaires with centralised 230V power supply. Diagnostics and control of the centralised luminaires.		Luminaires in which protection against electric shock is guaranteed by an Insulation Class II built.
	Emergency luminaires with centralised 24V power supply. Diagnostics and control of the centralised luminaires.		General temperature range in which the luminaire maintains correctly its characteristics. For details of the characteristics of each individual product, please refer to the electronic catalogue at www.beghelli.it .
	Emergency luminaires with centralised power supply, without diagnostics.		European quality label. Voluntary certification to testify to the quality of the product and the production chain.
	Luminaires with an LTO Lithium Battery. Thanks to the special features of the battery, these luminaires come with a 10-year warranty for all components, including the battery.		Luminaire intended for use in areas where there is a risk of explosion due to the presence of explosive substances (dust and/or gas...) according to the ATEX Directive .

Analytical index

LUMINAIRES

Order Code	Price €	Page	Order Code	Price €	Page	Order Code	Price €	Page
250SA	74.00	029	4300	91.66	037	8596	115.75	035
250SE	65.50	029	4301	120.70	037	8597	115.10	033
250ATSA	86.00	029	4302	143.90	037	8598	143.60	033
250ATSE	76.30	029	4303	191.48	037	12182	334.60	015
250ATSAUV	241.05	071	4304	216.76	037	12182FM	464.91	013
250ATSEUV	232.03	071	4320	138.11	089	12183	345.35	013
250SAUV	231.25	071	4321	149.71	089	12183FM	477.30	013
250SEUV	223.23	071	4322	530.00	089	12184	511.13	013
500ATSA	158.08	029	4330	103.29	051	12184FM	632.37	013
500ATSAUV	443.08	071	4331	116.00	051	12185	472.66	013
500ATSE	139.99	029	4334	112.52	051	12185FM	596.63	013
500ATSEUV	425.71	071	4335	125.18	051	12186	485.05	013
500SA	109.19	029	4370	160.49	037	12186FM	609.05	013
500SE	100.58	029	4371	219.76	037	12187	637.00	013
500SAUV	341.22	071	4372	250.52	037	12187FM	760.88	013
500SEUV	342.79	071	4372BA	259.00	091	15030	522.23	063
824L	77.02	037	4373	311.47	037	15032	686.93	063
824M	64.19	037	4380	182.79	089	17403	92.90	013
824S	56.74	037	4381	194.36	089	17404	95.48	013
824BA	104.91	091	4390	138.20	051	17405	98.06	013
824LSA	121.33	037	4391	219.79	051	17406	107.87	013
824MSA	95.65	037	4393	152.02	051	17423	95.00	045
1499	46.35	043	4400	57.84	031	17424	115.00	045
1499/24	47.38	043	4401	71.08	031	17435	100.16	026
1499L	50.99	043	4402	107.09	031	17436	103.50	026
1499LUV	186.00	071	4403	72.39	031	17437	106.83	026
4101	77.30	039	4404	85.59	031	17438	117.99	026
4102	90.89	039	4405	151.13	031	17452	143.06	063
4103	103.49	039	4601	96.07	057	17876	157.50	047
4104	164.38	039	4602	108.01	057	17877	170.50	047
4105	164.74	039	4603	125.16	057	17878	157.50	049
4106	220.46	039	4605	162.99	057	17879	170.50	049
4107	109.82	039	4607	54.12	055	17880	136.50	081
4108	113.30	039	4609	67.83	055	17881	124.80	081
4109	178.93	039	4611	31.23	059	17882	110.76	081
4110	183.35	039	4612	40.91	059	17890	184.80	087
4111	252.03	039	8584	81.37	033	17891	208.00	087
4200	121.50	039	8585	190.04	033	17892	221.76	087
4201	141.55	039	8586	91.67	033	17893	249.60	087
4202	195.82	039	8587	203.26	033	17894	184.80	087
4203	224.26	039	8590	112.65	033	17895	201.60	087
4204	268.03	039	8591	135.39	033	17896	221.76	087
4290A	72.59	079	8592	196.83	033	17897	246.53	087
4291A	81.35	079	8593	245.76	033	17898	161.70	087
4292A	93.85	079	8594	71.07	035	17899	176.40	087
4293A	108.88	079	8595	81.37	035			

* For the commercial conditions, please contact the Beghelli sales network

NEXT >

Analytical index

emergency

LUMINAIRES

Order Code	Price €	Page	Order Code	Price €	Page	Order Code	Price €	Page
17900	203.28	087	19338	179.37	049	19620	176.55	077
17901	221.76	087	19339	197.62	049	19621	241.73	077
17902	402.04	083	19355L	134.20	095	19622	275.58	077
17903	451.09	083	19358	78.51	093	19623	339.35	077
17904	300.43	083	19359	101.27	093	19700	140.65	081
17908	354.64	085	19367	91.35	093	19711	190.01	081
17909	354.64	085	19368	207.52	093	19712	237.53	081
17910	360.36	085	19370	251.12	065	19800	157.30	087
17911	120.00	089	19371	118.66	093	19801	170.52	087
17912	144.00	089	19373	212.67	093	19802	188.76	087
17913	460.50	089	19378	473.47	065	19803	204.61	087
17914	120.00	089	19390	163.23	097	19810	208.18	087
17915	144.00	089	19391	147.69	097	19811	221.37	087
17916	460.50	089	19410	307.96	013	19812	239.41	087
17917	105.00	089	19411	346.46	013	19813	254.56	087
17918	126.00	089	19420	158.85	045	31053	341.64	063
17919	402.94	089	19421	279.83	045	31054	273.31	063
18200	398.74	083	19430	105.98	025	31090	240.00	053
18201	469.14	083	19430UV	269.39	073	31092	147.40	053
18400	337.41	085	19431	115.23	025	31099	243.05	013
18401	446.55	085	19431UV	278.37	073	31112	208.36	065
19200	122.89	025	19432	165.84	025	31113	166.69	065
19201	150.58	025	19432UV	327.51	073	31120	233.72	013
19202	163.66	025	19433	177.08	025	31121	145.00	045
19203	228.68	025	19433UV	338.42	075	31122	151.40	026
19204	302.01	025	19434	277.16	026	31123	204.00	045
19205	334.66	025	19435	310.43	026	31124	129.03	026
19206	171.73	025	19450	80.34	017	31125	133.33	026
19207	245.06	025	19450UV	244.50	075	31140	201.29	013
19208	310.24	025	19451	172.46	017	31141	214.83	013
19209	375.44	025	19451UV	333.94	075	31150	137.63	026
19210	269.48	025	19452	94.09	017	31170	161.81	017
19211	368.76	025	19452UV	257.85	075	31171	201.85	017
19212	378.71	025	19453	200.08	017	31172	207.84	021
19213	465.09	025	19453UV	360.75	075	31174	110.32	017
19290	165.64	025	19454	180.00	017	31175	107.13	017
19291	180.51	025	19455	210.00	017	31176	166.27	021
19292	261.46	025	19460	248.75	017	31208	264.00	053
19293	326.01	025	19460UV	408.00	075	31210	162.14	053
19294	282.25	025	19461	275.78	021	32055	341.64	063
19295	333.67	025	19470	301.74	017	32067	220.00	053
19296	407.56	025	19471	323.37	021	32083	208.36	065
19320	100.16	047	19600	73.11	077	32089	210.35	013
19328	179.37	047	19601	87.73	077	32090	130.00	045
19329	197.62	047	19602	108.93	077	32091	151.40	026
19330	100.16	049	19603	138.20	077	32092	273.31	063

* For the commercial conditions, please contact the Beghelli sales network

LUMINAIRES

Order Code	Price €	Page
32093	150.00	045
32094	116.13	026
32096	167.23	013
32110	139.01	017
32111	192.14	017
32112	247.43	021
32122	242.00	053
37126	259.56	053
37127	304.31	053
37128	372.01	053
37236	285.52	053
37237	334.75	053
37238	409.21	053
81143	50.90	061
81144	52.90	061
R0818	152.31	025
R1124	162.94	025
R1124SA	257.08	025
R2436	248.62	025
R2436SA	322.91	025

ACCESSORY

Order Code	Price €	Page
2741	9.07	033
2742	9.76	029
2751	20.74	029, 031
3723	6.27	018, 022, 029, 031, 071, 075
3727	6.98	031, 035, 045
3733	13.16	040, 043, 069, 079
3893	4.97	031
3903	37.22	037, 077
3905	98.18	033, 035, 063
3912	46.45	014, 018, 022, 026, 029, 031, 040, 043, 069
4112	16.18	040
4117	4.97	029, 071
4124	46.66	029, 071
4125	46.66	029, 071
4126	46.66	029, 071
4265	38.76	040, 043, 079
4266	30.97	040, 043, 069, 079
4267	62.00	040, 043, 079
4268	62.00	040, 043, 079
4269	16.09	040, 043, 069, 079
4278	8.22	040, 043, 069, 079
4312	41.56	089
4313	45.12	089
4315	68.89	018, 022, 075, 089
4316	77.19	018, 022, 075, 089
4317	86.70	018, 022, 075, 089
4318	7.00	037
4319	47.51	037, 077, 089, 091
4325	19.44	033
4326	9.06	037
4329	6.40	077
4681	72.66	018, 075
4682	6.40	018, 075
4683	12.98	022, 018
4685	19.47	020, 018, 075
4686	20.03	018, 075
4687	27.58	018, 022
11593	12.31	033, 035
11594	12.31	033, 035
11595	12.31	033, 035
12175	19.52	014
12176	19.52	014
12177	19.52	014
12178	20.85	014
12179	13.59	014
12180	22.10	014

Order Code	Price €	Page
12199	20.37	014
12941	9.55	045
12942	16.92	045
12943	20.29	045
14771	23.00	089
15043	37.85	066
15044	75.17	066
15048	10.00	029, 031
19040	15.05	026
19041	50.77	026
19042	53.66	026, 073
19043	53.66	026, 073
19044	6.62	026, 073
19045	10.16	026, 089, 073
19046	59.37	063
19048	17.81	026
19049	54.63	026
19064	103.88	063
19376	55.97	095, 097
19880	60.00	087
19881	70.00	087
19882	46.35	087
19883	59.23	081
19884	71.28	087
20155	15.00	018, 022
20156	16.00	018, 022
26723	90.00	071, 073, 075
26724	88.00	069
81236	6.70	061
81237	6.70	061
81296E	23.10	061
F95807	15.00	047, 049
F95808	15.00	047, 049
F95815	15.00	047, 049
F95819	10.00	047, 049
RA01	12.26	026
RA04	47.01	018, 014, 022, 045
RA05	24.52	045
RA06	17.73	026, 095
RA07	69.00	097
RA08	36.00	063, 097

* For the commercial conditions, please contact the Beghelli sales network

NEXT >

Analytical index

emergency

CONTROL SYSTEMS

Order Code	Price €	Page	Order Code	Price €	Page	Order Code	Price €	Page
2730	188.36	026,031,037,051,081,083, 085,091,089	17606	6,300.00	113	17658	24,000.00	115
12100C	1,000.00	101	17610	6,500.00	113	17659	23,500.00	115
12101	327.59	107	17611	6,650.00	113	17660	23,950.00	115
12128C	1,400.00	103	17612	6,450.00	113	17661	24,400.00	115
12131C	2,300.00	101	17613	7,650.00	113	17662	24,550.00	115
15036	45.88	105	17614	7,785.00	113	17663	25,050.00	115
15037	69.39	105	17615	7,965.00	113	17664	25,550.00	115
15038	81.94	105	17616	9,115.00	113	17665	26,500.00	115
15047	74.11	105	17617	9,300.00	113	17666	27,000.00	115
17060	2,700.00	124	17618	8,980.00	113	17667	27,500.00	115
17061	3,000.00	124	17620	8,650.00	114	17668	27,000.00	115
17062	4,000.00	124	17621	8,350.00	114	17669	27,500.00	115
17063	4,400.00	124	17622	8,550.00	114	17670	28,000.00	115
17064	2,700.00	116	17623	9,500.00	114	17671	35,000.00	115
17065	4,300.00	124	17624	9,700.00	114	17672	35,750.00	115
17066	4,900.00	124	17625	9,500.00	114	17673	36,500.00	115
17075	4,500.00	125	17626	10,300.00	114	17674	40,000.00	115
17076	5,500.00	125	17627	10,500.00	114	17675	40,500.00	115
17077	4,900.00	125	17628	10,800.00	114	17676	41,250.00	115, 126
17078	6,400.00	125	17629	11,500.00	114	17680	4,500.00	116
17206N	103.00	126	17630	11,700.00	114	17681	5,250.00	116
17207	242.05	119,126	17631	12,000.00	114	17682	6,500.00	116
17208	262.65	119,126	17632	12,600.00	114	17685	1,550.00	117
17210	116.26	126	17633	12,850.00	114	17686	2,550.00	117
17220	90.86	126	17634	13,500.00	114	17700	2,576.12	133
17226	87.55	119,126	17635	15,000.00	114	17701	*	133
17230	164.80	117, 126	17636	15,300.00	114	17702	*	133
17231	180.25	117, 126	17637	15,600.00	114	17703	3,864.17	133
17232	412.00	119	17638	16,500.00	114	17704	*	133
17233	412.00	119	17639	16,850.00	114	17705	*	133
17234	442.90	119	17640	17,200.00	114	17706	5,152.23	133
17235	412.00	119	17641	19,000.00	114	17707	*	133
17236	40.50	117	17642	19,400.00	114	17708	*	133
17237	29.87	119	17643	19,750.00	114	17709	7,728.34	133
17240	1,431.70	119,126	17644	20,500.00	114	17710	*	133
17381	81.77	118	17645	20,900.00	114	17711	*	133
17382	74.16	118	17646	21,350.00	114	17712	9,016.40	133
17383	81.37	118	17650	20,500.00	115	17713	*	133
17384	566.50	119	17651	21,000.00	115	17714	*	133
17385	105.00	119	17652	21,350.00	115	17715	11,592.52	133
17601	5,185.00	113	17653	21,900.00	115	17716	*	133
17602	5,345.00	113	17654	22,350.00	115	17717	*	133
17603	5,600.00	113	17655	22,750.00	115	17718	15,456.69	133
17604	5,650.00	113	17656	23,250.00	115	17719	*	133
17605	6,165.00	113	17657	23,650.00	115	17720	*	133

* For the commercial conditions, please contact the Beghelli sales network

CONTROL SYSTEMS

Order Code	Price €	Page
19375	67.16	105
20151	173.04	099
20157	1,100.00	099, 101, 103
21102	1,400.00	105
34000	638.40	131
34002	560.00	131
RA09	39.24	117

Spare batteries

emergency

BATTERIES FOR SELF-CONTAINED EMERGENCY LUMINAIRES

Order code Luminaires	Order code battery	Description battery	Order code Luminaires	Order code battery	Description battery	Order code Luminaires	Order code battery	Description battery
250ATSA	415419001	LTO 4.8V 1.2Ah	4304	415399001	NiMh 3.6V 1.5Ah	12184	415139000	Pb 6V 4Ah
250ATSE	415419001	LTO 4.8V 1.2Ah	4320	415401001	NiCd 3.6V 0.75Ah	12184FM	415139000	Pb 6V 4Ah
250ATSAUV	415436001	LiFe 3.2V 1.5Ah	4321	415098001	NiMH 3.6V 1.2Ah	12185	415409001	NiMh 7.2V 2.5Ah
250ATSEUV	415436001	LiFe 3.2V 1.5Ah	4322	415098001	NiMH 3.6V 1.2Ah	12185FM	415409001	NiMh 7.2V 2.5Ah
250SA	415436001	LiFe 3.2V 1.5Ah	4330	415436001	LiFe 3.2V 1.5Ah	12186	415409001	NiMh 7.2V 2.5Ah
250SE	415436001	LiFe 3.2V 1.5Ah	4331	415436001	LiFe 3.2V 1.5Ah	12186FM	415409001	NiMh 7.2V 2.5Ah
250SAUV	415436001	LiFe 3.2V 1.5Ah	4334	415436001	LiFe 3.2V 1.5Ah	12187	415409001	NiMh 7.2V 2.5Ah
250SEUV	415436001	LiFe 3.2V 1.5Ah	4335	415441001	LiFe 3.2V 3Ah	12187FM	415409001	NiMh 7.2V 2.5Ah
500ATSA	415441001	LiFe 3.2V 3Ah	4370	415417001	LTO 4.8V 0.5Ah	1499	415438001	Pb 4V 3Ah
500ATSE	415441001	LiFe 3.2V 3Ah	4371	415420001	LTO 4.8V 1Ah	1499/24	415438001	Pb 4V 3Ah
500ATSAUV	415441001	LiFe 3.2V 3Ah	4372	415417001	LTO 4.8V 0.5Ah	1499L	415441001	LiFe 3.2V 3Ah
500ATSEUV	415441001	LiFe 3.2V 3Ah	4373	415420001	LTO 4.8V 1Ah	1499LUV	415436001	LiFe 3.2V 1.5Ah
500SA	415441001	LiFe 3.2V 3Ah	4380	415423001	LTO 7.2V 0.5Ah	15030	415391001	NiMh 7.2V 1.2Ah
500SE	415441001	LiFe 3.2V 3Ah	4381	415433001	2 x LTO 7.2V 0.5Ah	15032	415444001	LiFe 12.8V 1.5Ah
500SAUV	415441001	LiFe 3.2V 3Ah	4390	415432001	LTO 7.2V 0.5Ah	18400	415436001	LiFe 3.2V 1.5Ah
500SEUV	415441001	LiFe 3.2V 3Ah	4391	415432001	LTO 7.2V 0.5Ah	18401	415433001	2x LTO 7.2V 0.5Ah
824BA	415049103	NiCd 3.6V 0.75Ah	4393	415432001	2 x LTO 7.2V 0.5Ah	19200	415072301	NiCd 3.6V 0.75Ah
824L	415098001	NiMH 3.6V 1.2Ah	4400	415437001	LiFe 3.2V 0.5Ah	19201	415097001	NiMH 3.6V 1.2Ah
824LSA	415098001	NiMH 3.6V 1.2Ah	4401	415436001	LiFe 3.2V 1.5Ah	19202	415072301	NiCd 3.6V 0.75Ah
824M	415049103	NiCd 3.6V 0.75Ah	4402	415441001	LiFe 3.2V 3Ah	19203	415097001	NiMH 3.6V 1.2Ah
824MSA	415049103	NiCd 3.6V 0.75Ah	4403	415437001	LiFe 3.2V 0.5Ah	19204	415072301	NiCd 3.6V 0.75Ah
824S	415049103	NiCd 3.6V 0.75Ah	4404	415436001	LiFe 3.2V 1.5Ah	19205	415097001	NiMH 3.6V 1.2Ah
4101	415072301	NiCd 3.6V 0.75Ah	4405	415441001	LiFe 3.2V 3Ah	19206	415072301	NiCd 3.6V 0.75Ah
4102	415072301	NiCd 3.6V 0.75Ah	4601	415170001	Li-ion 3.2V 0.1Ah	19207	415097001	NiMH 3.6V 1.2Ah
4103	415072301	NiCd 3.6V 0.75Ah	4602	415268001	NiCd 2.4V 0.4Ah	19208	415072301	NiCd 3.6V 0.75Ah
4104	415097001	NiMH 3.6V 1.2Ah	4603	415268001	NiCd 2.4V 0.4Ah	19209	415097001	2 x NiMH 3.6V 1.2Ah
4105	415072301	NiCd 3.6V 0.75Ah	4605	415269001	NiCd 4.8V 0.4Ah	19210	415072301	2 x NiCd 3.6V 0.75Ah
4106	415097001	NiMH 3.6V 1.2Ah	4607	415278000	LiFe 3.2V 0.2Ah	19211	415097001	2 x NiMH 3.6V 1.2Ah
4107	415072301	2 x NiCd 3.6V 0.75Ah	4609	415416001	NiCd 3.6V 0.4Ah	19212	415072301	2 x NiCd 3.6V 0.75Ah
4108	415072301	2 x NiCd 3.6V 0.75Ah	4611	415421001	NiCd 3.6V 0.4Ah	19213	415097001	NiMH 3.6V 1.2Ah
4109	415097001	2 x NiMH 3.6V 1.2Ah	4612	415277001	NiCd 3.6V 0.4Ah	19290	415419001	LTO 4.8V 1.2Ah
4110	415072301	2 x NiCd 3.6V 0.75Ah	8584	415444001	LiFe 9.6V 1.5Ah	19291	415419001	LTO 4.8V 1.2Ah
4111	415097001	2 x NiMH 3.6V 1.2Ah	8585	415444001	LiFe 9.6V 1.5Ah	19292	415419001	2 x LTO 4.8V 1.2Ah
4200	415418001	LTO 4.8V 0.5Ah	8586	415444001	LiFe 9.6V 1.5Ah	19293	415419001	2 x LTO 4.8V 1.2Ah
4201	415418001	LTO 4.8V 0.5Ah	8587	415444001	LiFe 9.6V 1.5Ah	19294	415419001	LTO 4.8V 1.2Ah
4202	415418001	2 x LTO 4.8V 0.5Ah	8590	415444001	LiFe 9.6V 1.5Ah	19295	415419001	2 x LTO 4.8V 1.2Ah
4203	415418001	LTO 4.8V 0.5Ah	8591	415444001	LiFe 9.6V 1.5Ah	19296	415419001	2 x LTO 4.8V 1.2Ah
4204	415418001	2 x LTO 4.8V 0.5Ah	8592	415444001	LiFe 9.6V 1.5Ah	19328	415432001	LTO 7.5V 0.5Ah
4290A	415097001	NiMH 3.6V 1.2Ah	8593	415444001	LiFe 9.6V 1.5Ah	19329	415432001	2 x LTO 7.5V 0.5Ah
4291A	415097001	NiMH 3.6V 1.2Ah	8594	415444001	LiFe 9.6V 1.5Ah	19338	415432001	LTO 7.2V 0.5Ah
4292A	415097001	NiMH 3.6V 1.2Ah	8595	415444001	LiFe 9.6V 1.5Ah	19339	415432001	2 x LTO 7.2V 0.5Ah
4293A	415097001	2 x NiMH 3.6V 1.2Ah	8596	415444001	LiFe 9.6V 1.5Ah	19355L	415444001	LiFe 9.6V 1.5Ah HT
4300	415049103	NiCd 3.6V 0.75Ah	12182	415139000	Pb 6V 4Ah	19358	415414001	NiCd 7.2V 0.75Ah
4301	415098001	NiMH 3.6V 1.2Ah	12182FM	415139000	Pb 6V 4Ah	19359	415415001	NiMH 7.2V 1.5Ah
4302	415399001	NiMh 3.6V 1.5Ah	12183	415139000	Pb 6V 4Ah	19367	415414001	NiCd 7.2V 0.75Ah
4303	415098001	NiMH 3.6V 1.2Ah	12183FM	415139000	Pb 6V 4Ah	19368	415415001	NiMH 7.2V 1.5Ah

Order code Luminaires	Order code battery	Description battery
19370	415419001	2 x LTO 4.8V 1.2Ah
19371	415415001	NiMH 7.2V 1.5Ah
19373	415415001	NiMH 7.2V 1.5Ah
19378	415462001	LiFe 12.8V 3Ah
19390	415439001	LTO 14.4V 1.2Ah
19391	415440001	LiFe 12.8V 1.5Ah HT
19410	415442001	2 x LTO 9.6V 1.2Ah
19411	415442001	2 x LTO 9.6V 1.2Ah
19420	415443001	2 x LTO 9.6V 0.5Ah
19421	415442001	2 x LTO 9.6V 1.2Ah
19430	415444001	LiFe 9.6V 1.5Ah
19430UV	415419001	2x LTO 4.8V 1.2Ah
19431	415444001	LiFe 9.6V 1.5Ah
19431UV	415419001	2x LTO 4.8V 1.2Ah
19432	415444001	LiFe 9.6V 1.5Ah
19432UV	415419001	2x LTO 4.8V 1.2Ah
19433	415444001	LiFe 9.6V 1.5Ah
19433UV	415419001	2x LTO 4.8V 1.2Ah
19434	415444001	LiFe 9.6V 1.5Ah
19435	415444001	LiFe 9.6V 1.5Ah
19450	415418001	LTO 4.8V 0.5Ah
19450UV	415418001	LTO 4.8V 0.5Ah
19451	415419001	LTO 4.8V 1.2Ah
19451UV	415419001	LTO 4.8V 1.2Ah
19452	415418001	LTO 4.8V 0.5Ah
19452UV	415418001	LTO 4.8V 0.5Ah
19453	415419001	LTO 4.8V 1.2Ah
19453UV	415419001	LTO 4.8V 1.2Ah
19454	415419001	2 x LTO 4.8V 1.2Ah
19455	415419001	2 x LTO 4.8V 1.2Ah
19460	415419001	2 x LTO 4.8V 1.2Ah
19460UV	415419001	2 x LTO 4.8V 1.2Ah
19461	415419001	2 x LTO 4.8V 1.2Ah
19470	415442001	2 x LTO 9.6V 1.2Ah
19471	415442001	2 x LTO 9.6V 1.2Ah
19600	415437001	LiFe 3.2V 0.5Ah
19601	415457001	LiFe 3.2V 1.5Ah
19602	415437001	LiFe 3.2V 0.5Ah
19603	415457001	LiFe 3.2V 1.5Ah
19620	415417001	LTO 4.8V 0.5Ah
19621	415420001	LTO 4.8V 1Ah
19622	415417001	LTO 4.8V 0.5Ah
19623	415420001	LTO 4.8V 1Ah
19700	415436001	LiFe 3.2V 1.5Ah
19711	415432001	2 x LTO 7.2V 0.5Ah
19712	415440001	LiFe 12.8V 1.5Ah

Order code Luminaires	Order code battery	Description battery
19800	415436001	LiFe 3.2V 1.5Ah
19801	415436001	LiFe 3.2V 1.5Ah
19802	415436001	LiFe 3.2V 1.5Ah
19803	415436001	LiFe 3.2V 1.5Ah
19810	415433001	LTO 7.2V 0.5AH
19811	415433001	2 x LTO 7.2V 0.5Ah
19812	415433001	LTO 7.2V 0.5AH
19813	415433001	2 x LTO 7.2V 0.5Ah
37126	415432001	2 x LTO 7.2V 0.5Ah
37127	415432001	2 x LTO 7.2V 0.5Ah
37128	415432001	2 x LTO 7.2V 0.5Ah
37236	415432001	2 x LTO 7.2V 0.5Ah
37237	415432001	2 x LTO 7.2V 0.5Ah
37238	415432001	2 x LTO 7.2V 0.5Ah
81143	81296E	Li-ion 3.7V 0.5Ah
81144	81296E	Li-ion 3.7V 0.5Ah
R0818	415072301	NiCd 3.6V 0.75Ah
R1124	415072301	NiCd 3.6V 0.75Ah
R1124SA	415072301	NiCd 3.6V 0.75Ah
R2436	415097001	NiMH 3.6V 1.2Ah
R2436SA	415097001	NiMH 3.6V 1.2Ah

General terms and conditions of sale

1. ORDERS - FINALISATION OF AGREEMENTS

Product purchase orders shall be formulated in writing. Order placement is deemed irrevocable. All collaboration programs, orders, work orders and agreements are considered finalised by the written or verbal confirmation of the Seller or, however, as soon as the invoicing and/or delivery of the ordered products is initiated.

2. VARIANTS AND MODIFICATIONS

After order finalisation, any modification or addition to the content and conditions of the order shall be valid and will become effective only after the Buyer receives a confirmation variant from the Seller. The text of the Seller's confirmation or confirmation variant shall in all cases prevail over any other document. If the Buyer does not intend to accept the conditions that differ from his/her order, he/she must inform the Seller within 20 (twenty) days from the date of confirmation; otherwise, the confirmation variant will be considered fully accepted.

3. METHOD OF ACCEPTANCE

The Seller shall not be held liable for any unaccepted orders or for any failed or delayed delivery of the products part thereof. Acceptance and execution of the order are specifically subject to the availability of the products ordered as well as the absence of circumstances that may affect the availability of the same and the timeliness of their delivery.

4. TERMS OF DELIVERY

The delivery terms communicated by the Seller are purely indicative. Delivery terms expressed in days are normally counted in working days. Any changes to the delivery terms requested by the Buyer must be first accepted in writing by the Seller. Any delay in deliveries, as well as any interruption and/or total or partial suspension of supplies, even if not due to force majeure and/or accidental circumstances, will not entitle the Buyer to compensation for damages and/or to any other kind of indemnity or interest, except for the sole right to cancel the order, provided that the Seller is notified in advance, with at least thirty days before the day of receipt of the registered letter with acknowledgement of receipt sent by the Buyer.

5. FORCE MAJEURE

By way of example, but not limited to, the following are considered cases of force majeure: strikes, lockouts, riots, labour conflicts, fires, natural disasters, impossibility of supplying products, interruptions or difficulties in transport, delays of shipment, lack of raw materials, government acts, authority measures, contractual non-fulfilment by suppliers and, in general, any unforeseeable event that is outside the reasonable control of the Seller. In all such cases, as well as in the event of any accidental circumstances, the Seller reserves the right to suspend and/or delay the delivery of the products and even cancel the orders, even if already confirmed; this will not entitle the Buyer to compensation for damages and/or to any other kind of indemnity, including those for direct, indirect and consequential loss.

6. DELIVERY - TRANSPORT

The goods always travel at the risk and danger of the Buyer, even if delivered carriage paid and/or using a vehicle of the Seller; therefore, the Seller will not accept disputes for any product breakage and/or tampering. The delivery of the products is intended to be carried out at the Seller's headquarters in Montevoglio - Valsamoggia (Bologna) or at third party warehouses with which the Seller has entered into special agreements ("Ex works" condition - Incoterms 2010). Transport costs are borne by the Buyer. The Seller does not accept returns.

7. COMPLAINTS - PRODUCT REPLACEMENT

Any requests for replacement and complaints shall be handled by applying the safeguards provided by the applicable legislation in relation to the specific type of customer, professional operator or consumer. Upon product receipt, the Buyer must check its condition, the quantity delivered and its compliance with the delivery note. Any complaints concerning product quality, quantity or type shall be submitted in writing within 8 (eight) days from the date of receipt of the goods. After this period, without prejudice to the warranty conditions provided for the individual products, no claim can be made regarding the material and quality of the goods, or their condition in general. The Buyer may not, under any circumstances, return the products without the prior written authorisation of the Seller, nor delay and/or suspend the payment of invoices in whole or in part, not even in the case of complaints. If, in the opinion of the Seller, the claim is justified and has been filed within the warranty terms stated in the booklets accompanying the individual products, the obligation of the latter is limited only to the replacement of the nonconforming product in accordance with the delivery terms established for the first delivery. It is, therefore, excluded any right of the Buyer to cancel the order or to obtain any compensation for expenses and/or damages. The right to replace

the contested product shall lapse if the product is not diligently stored, kept at the disposal of the Seller, and returned immediately to the place determined by the Seller.

8. APPLICATION OF WARRANTY

The warranty applies only to faults and/or defects in the conformity of the product in relation to the terms and conditions indicated in the declared and/or agreed technical specifications or in case of premature breakage of one of its parts. The validity period of the aforementioned warranty is at least 24 months from the date of purchase, which can be proved by presenting a valid tax document. Luminaires with extended warranties are marked in catalogues or instruction sheets with the number of years of total warranty in conjunction with the letter G (e.g., 5G marking for products with a 5-year warranty). As a general rule, the following extensions apply: emergency luminaires equipped with Lithium Iron batteries (LiFe) and centralised emergency lighting systems benefit from a 5-year warranty, those equipped with Lithium Titanate batteries (LTO) benefit from a 10-year warranty (for all parts, including batteries); EcoDriver or Dimmable luminaires benefit from a 3-year warranty, SmartDriver luminaires benefit from a 5-year warranty (for all parts, including sources). The warranty does not apply in case of tampering, to defects caused by accidental damage of any kind, including during transport and installation, in case of improper use or use in disagreement with the product specifications, in case of negligence in use and maintenance, errors in installation or connection, and installation performed by unqualified personnel or without respecting the state-of-the-art standards. Unless otherwise required by applicable law, the warranty is limited only to the replacement/repair of nonconforming products or parts, according to the delivery terms of the first delivery. All work performed under warranty by the Seller shall be subject to observance of the payment conditions by the Buyer.

9. PRICES

The prices indicated in the Seller's price lists are not binding; therefore, the Seller reserves the right to modify them until the time of delivery of the products. All prices are exclusive of VAT and any other tax charges.

10. PAYMENTS

All payments shall be made, within the terms and in the manner indicated by the Seller, to its headquarters in Montevoglio - Valsamoggia (Bologna) or to the appointed person authorised in writing by the Seller. In case of delay in payment, the defaulting buyer will be obliged to pay the Seller interests on late payment from the date of expiry of the contractual period until settlement, to the extent provided for in Legislative Decree 231/2002, apart from any compensation for any further damages incurred. Failure to comply with the payment terms by the Buyer will give the Seller the right to terminate the corresponding supply contract with immediate effect and to suspend the delivery of all products ordered without the need for any communication, with the consequent right of the Seller to demand the immediate payment of the entire credit as well as to claim compensation for the damages incurred. In case of non-fulfilment and/or worsening of the patrimonial conditions of the Buyer to a degree that may jeopardise the collection of the credit by the Seller, as well as in the event of prolonged delay in payments and/or high total debt exposure (also due to previous uncollected sales), the Seller reserves the right to apply the provisions of art. 1460 and 1461 CC, undertake appropriate precautionary actions and resort to any other form of self-protection permitted; it is further agreed that in such cases the Seller may suspend any and all supplies.

11. LIEN AGREEMENT

The products sold are subject to a lien agreement; therefore, the Seller will retain possession of the goods sold until their price is paid in full. The Buyer, therefore, undertakes to inform third parties of the existence and effectiveness of this Lien Agreement, as well as to safeguard the Seller's rights deriving from the same.

12. SAFEGUARDING – DISPUTES AND JURISDICTION

The invalidity or unenforceability of any of the clauses contained in these general conditions of sale shall not affect, or detract from the validity and enforceability of the other provisions; the Seller and the Buyer undertake to replace any clauses declared ineffective and/or null, or impracticable, with other provisions having similar effects. For any dispute or contestation relating to the interpretation, validity and execution of the order or, in any case, concerning the contracts to which these general conditions of sale apply shall be governed by the Italian Law. The Forum of Bologna shall have exclusive jurisdiction.

Product safety and European Directives

PRODUCT SAFETY AND EUROPEAN DIRECTIVES

Beghelli products are manufactured according to the state-of-the-art standards concerning safety and quality and will not affect, even when used under foreseeable overload conditions, the safety of persons, pets and property, on condition that they are correctly installed and used according to their intended purpose in the recommended environmental conditions and subject to proper maintenance by qualified personnel.

To the extent applicable, the products shall be manufactured in accordance with the requirements of Community Directives 2014/35/EU, 2014/30/EU, 2014/53/EU, 2014/30/EU, 2009/125/CE, 2001/65/CE.

The CE marking affixed to the product and/or packaging and/or any warnings of use accompanying the product attest to the conformity of the product with the aforementioned Directives. Beghelli has its own Technical Archive, available to the competent authorities for possible inspections, containing documentation demonstrating that the product has been examined to assess its compliance.

Products that do not fall within the scope of the above-mentioned EC Directives comply with the quality standards laid down by the regulations in force and by Directive 2001/95/CE ("General Product Safety Directive"), transposed by Legislative Decree No. 172/2004.

The data contained in this catalogue may be subject to change without notice.

The indications, dimensions, drawings and photos of the products and components are given for informational purposes only and may be modified without prior notice, as they do not constitute pre-contractual information. All products intended to be connected to the mains shall be installed in compliance with the installation standards in force in the country of use, observing the information contained in the Catalogue and/or the relevant instructions supplied with the product itself.

Environmental protection

WEEE DIRECTIVE 2012/19/EU

The quantities of waste from electrical and electronic equipment (WEEE) are rapidly increasing; most of the light sources are included in this category.

The main aim of the directive is to prevent WEEE from being discarded to landfills or incinerators at the end of their life, thereby causing further serious environmental impact.

Directive 2012/19/EU, therefore, sought to induce a control mechanism which provides for a controlled end-of-life management of the device by giving priority to its reuse or recycling. In addition, the legislative mechanism promotes design and production concepts that make it easier to dispose of the products in terms of both their disassembly and their materials.

All supply chain participants are invited to make their own contribution, some with regard to the economic aspects, some in terms of activity, so that the spirit of the directive is respected (and the environment is protected).

In Italy, the Directive has been transposed by Legislative Decree No. 49 of 14 March 2014.

THESE ARE THE MAIN OBLIGATIONS FORESEEN

The manufacturer (understood in a broad sense and, therefore, essentially as the person who affixes one's own brand on the goods and who imports them from third countries) is responsible for the costs of disposing of their products at the end of their life.

The consumer is required to guarantee an intelligent end-of-life management of the product by sending it to a specially equipped site, a point of sale or by observing the instructions provided by the manufacturer.

Beghelli, always sensitive to environmental issues, is one of the founding members of the ECOLIGHT consortium.

Choosing products from companies that have joined voluntary consortia for the recovery and recycling of goods is the responsible and ecologically correct choice to protect the environment and our future.

Products falling under the scope of the WEEE Directive are identified by this symbol.



ROHS DIRECTIVE 2011/65/UE

In order to facilitate the recovery and recycling of electrical equipment and to prevent hazardous substances from accumulating into the environment, the European Community has enacted the ROHS Directive. Essentially, this Directive states that:

Without prejudice to Annex 3, the placing on the market of new electrical and electronic equipment falling within the categories identified in Annex 1 containing lead, mercury, cadmium, hexavalent chromium, polybrominated biphenyls (PBB) or polybrominated diphenyl ether (PBDE) in excess of the value indicated in Annex 2, shall be prohibited.

In Italy, the Directive has been transposed by Legislative Decree No. 27 of 4 March 2014.



The technical data and images in this catalogue are subject to continuous development and may change without notice. To check the latest technical update of the luminaires, please refer to the electronic catalogue on www.beghelli.com.

Digital catalogues of the various product ranges are also available on the website and can also be requested in hard copy from:
BEGHELLI S.p.A. - Commercial Division - Via Mozzeghine, 13/15
Valsamoggia Loc. Monteveglio - 40053 BO

© Copyright 06/2021



BEGHELLI S.p.A. Via Mozzeghine 13/15 - 40053 Valsamoggia loc. Monteveglio
Bologna - Italy - Tel. +39 051 9660411 - info@beghelli.it - www.beghelli.com

l i g h t i n g

t w e n t y - o n e



REVERSOS

Beghelli

Let's start embracing the Earth again

Since 1982, we have been focusing on the interaction between technology and safety, a concept that has evolved up to now, and which for us translates into offering people the opportunity to enjoy a healthy and peaceful working and living environment.

LIGHT, the core of our business, now integrates more than ever those elements of well-being, safety and respect for the environment, which are the values and mission of our company.

We work directly with industrial and commercial entities in 9 different countries, and we distribute products in other 100 countries, safeguarding the human rights and equal opportunities of our collaborators.

Our passion for innovation, research and services translates into a technological offer that is ever closer to people's needs, while safeguarding the planet. Products such as the Salvalavita, the LED emergency luminaires and high energy-saving lighting are just a few examples.

We strongly believe that the only possible future is through respect for the environment. This is why we have a certified environmental management system.

This is why "ArchiEco", an architectural emergency range made of technopolymers of organic origin. This is why Titanium dioxide batteries, with a service life of up to 10 years, more than double that of conventional batteries.

This is why intelligent luminaires, with energy savings of up to 30% compared to standard LED luminaires.

This is why "SanificaAria", a technology capable of fighting Covid-19 as well as other flu viruses and bacteria, integrated, through a worldwide patent, even into a range of hybrid luminaires for lighting and emergency lighting.

In the years to come we will all have to think differently and act urgently to build a more sustainable future.

We will continue to strive to come up with innovations that help protect the safety of people and the environment in which we live and future generations will live.

The Beghelli SavePlanet project



professional

g

n

i

t

h

g

i

l

twenty-one



Subject index

Systems and luminaires	p.002
Control and communication systems.....	p.006
Control Unit and SD Manager.....	p.008
System modules.....	p.010
Hybrid luminaires with integrated air sanitizer.....	p.012
Recessed.....	p.018
Downlight.....	p.034
Systems - ceiling and suspended mounting.....	p.040
Waterproof ceiling lights.....	p.052
Outdoor floodlights.....	p.066
Industrial high bay lights.....	p.078
Street lighting.....	p.084
Exclusive proposals	p.004
NuBe Beghelli cloud.....	p.004
Driver SD - X.....	p.004
Driver SD - RADIO.....	p.004
SanificaAria system.....	p.005
Autodimmer Natural Light.....	p.005
Emergency module Plug&Light.....	p.005
Key to symbols	p.090
Analytical index	p.091
Chemicals resistance	p.094
General terms and conditions of sale	p.096

Luminaire selection guide

	FAMILY LUMINAIRES LIGHTING	PAGE	VERSION										MOUNTING				
			Standard	Adjustable	Centralised control			Temp. colour change	Multioptics	SanificaAria	Autodimmer	Inverter	INDOOR	OUTDOOR	RECESSED	CEILING	
			ED	RD	DALI	SD RADIO	SD -X-	CCT/HCL	SIM/ASIM and/or DIFF/CONC/ELLIT		NATURL LIGHT	MODULO PLUG&LIGHT					
RECESSED	LED PANEL RTI	012			✓	✓		✓			✓	✓	✓	✓		✓	✓
	MODULO 60X60 SanificaARIA	016				✓				✓			✓			✓	✓
	LENS PANEL	022	✓		✓		✓				✓	✓	✓			✓	✓
	LED PANEL	026	✓		✓		✓				✓	✓	✓	✓		✓	✓
	I 418	032			✓		✓				✓	✓	✓			✓	✓
DOWNLIGHT	DOWNLIGHT IP54	034	✓		✓		✓				✓	✓	✓	✓		✓	✓
	FUNZIONE3	036	✓				✓	✓	✓		✓	✓	✓			✓	✓
SYSTEMS	RAIL SYSTEM IRON	040	✓			✓					✓		✓				
	LENS FILA	046	✓		✓		✓				✓	✓	✓				✓
	P236/258	050			✓		✓				✓	✓	✓				✓
WATERPROOF	BS100	052		✓	✓		✓				✓	✓	✓	✓			✓
	ACCIAIO	056		✓	✓		✓				✓	✓	✓	✓			✓
	ACCIAIO EXTREME	060			✓		✓				✓	✓	✓	✓			✓
	BS240	062	✓		✓		✓				✓	✓	✓	✓			✓
FLOODLIGHTS	FLOOD MINI	066	✓						✓				✓	✓			
	FH-M	068		✓	✓	✓			✓		✓		✓	✓			✓
	FH-L	072		✓	✓	✓			✓		✓		✓	✓			✓
	POWER LIGHT	076	✓		✓	✓									✓		
HIGH BAY LIGHTS	H-PRO	078		0-10V	✓	✓					✓		✓	✓			✓
	HIGHBAY HP	082	✓			✓			✓				✓	✓			✓
STREET LIGHTING	STRADA	084			✓		✓							✓			
	CENTRO STRADA	088			✓		✓										

✔ Recommended

✔ Recommended in the Saniferon

✔ Optional

		APPLICATIONS										POWER MAX W	LED MAX lm	BRIGHTNESS (no auto-dimmer) lm/W	CHROMATIC YIELD CRI	BEAM CONTROL UGR
		Industry		Services												
SUSPENDED	POLE MOUNT	ATEX	NORMAL	LOGISTICS	SCHOOLS	HOSPITALS	SHOPPING CENTRES	HOTELS	SHOPS	OFFICES	PARKING					
✔					✔	✔	✔	✔	✔	✔		50	7000	140	>90	<19
✔					✔	✔	✔	✔	✔	✔		60				
✔					✔	✔	✔	✔	✔	✔		56	7000	125	>90	<19
✔					✔	✔	✔	✔	✔	✔		36	4000	111	>90	<19
					✔	✔	✔	✔	✔	✔		36	4000	111	>80	<19
					✔	✔	✔	✔	✔	✔		35	3500	100	>90	<19
✔					✔	✔	✔	✔	✔	✔		24	2700	113	>90	<19
✔					✔		✔		✔	✔		50	8000	160	>80	
✔					✔		✔		✔	✔		67	9000	134	>80	<19
✔					✔	✔	✔	✔	✔	✔		47	5100	109	>80	<19
			✔								✔	74	9600	130	>80	
		✔	✔								✔	74	9900	134	>80	
		✔	✔									74	9900	134	>80	
✔			✔				✔				✔	160	21300	133	>80	
			✔		✔	✔	✔	✔	✔			37	4000	108	>80	
✔	✔		✔		✔	✔	✔	✔			✔	110	16800	153	>80	
✔	✔		✔		✔	✔	✔	✔			✔	200	32400	162	>80	
	✔										✔	400	52000	130	>80	
✔			✔	✔								246	38850	158	>80	
✔			✔	✔								240	34000	142	>80	
	✔		✔	✔	✔	✔	✔	✔		✔	✔	130	16900	130	>80	
✔			✔	✔	✔	✔	✔	✔		✔	✔	130	15000	115	>80	

Table of Contents

POWER SUPPLY AND CONTROL SYSTEMS

SD

SD-X • EXPANDABLE WITH SMART AUTO-DIMMER
Luminaires equipped with **Smart Driver** with smart Auto-dimmer and integrable optional expansion modules :

- DALI Module
- Radio Module
- 1÷10V module
- Emergency inverter



SD RADIO • SMART AUTO-DIMMER AND RADIO
Luminaires equipped with **SD/1 ÷10V interface** with **integrated radio module** and optional integrated or external **Smart Auto-dimmer sensor**.



AUTO-DIMMER

CONTROL UNITS AND CONNECTION MODULES



P. 004



Logica SD LGFM Control Unit
SD, LGFM
SD

P. 008



System modules
SD

P. 010

Sanifica ^{Aria} Beghelli - HYBRID LUMINAIRES WITH INTEGRATED AIR SANITIZER

NEW



LED Panel RTI SanificaAria
CRI>90 - UGR<19
SD RD DALI

IP20

P. 012

NEW



Modulo 600 SanificaAria
SANITISATION ONLY

IP20

P. 016

RECESSED

NEW



LED Panel RTI
CRI>90 - UGR<19
SD ED DALI

IP40-IP20

P. 018



Lens Panel
CRI>90 - UGR<19
SD ED DALI

IP40-IP20

P. 022



Led Panel
CRI>90 - UGR<19
SD ED DALI

IP65 - IP20

P. 026 - 028

DOWNLIGHT



Downlight IP54
CRI>90 - UGR<19
SD ED DALI

IP54

P. 034



Funzione3
CRI>90 - UGR<19
SD ED DALI

IP40-IP20

P. 036

WATERPROOF CEILING LIGHTS



BS100
SD RD DALI

IP65

P. 052

NEW



Acciaio
SD RD DALI

IP66

P. 056



Acciaio Extreme
SD DALI

IP66

P. 060

OUTDOOR FLOODLIGHTS



Flood Mini
ED

IP66

P. 066

NEW



FH-M
SD RD DALI

IP66

P. 068

NEW



FH-L
SD RD DALI

IP66

P. 072

INDUSTRIAL HIGH BAY LIGHTS

NEW



H-PRO
SD RD DALI

IP66

P. 078



Highbay HP
SD ED

IP65

P. 082

RD**RD - ADJUSTABLE**

Luminaires equipped with **Adjustable Driver** with luminous flux modulation by means of an integrated 4-step switch.

This variable power supply system ensures the right lighting **and maximum energy savings**.

ADJUSTABLE

ED**ED - STANDARD**

Luminaires equipped with a 0÷10V **standard**

LED Driver with fixed light or **dimmable**.

ON / OFF

DALI**DALI**

Luminaires with **DALI** communication protocol

DALI

**I 418**

IP54-IP20

SD DALI

P. 032

SYSTEMS - CEILING AND SUSPENDED MOUNTING**Rail System Iron**

IP40

SD ED

P. 040

**Lens Fila**

IP40

SD ED DALI

P. 046

**P236/258**

IP20

UGR<19**SD DALI**

P. 050

**BS240**

IP66

SD ED DALI

P. 062

**Power Light**

IP66

SD ED DALI

P. 076

STREET LIGHTING**Strada**

IP66

SD DALI

P. 084

**Centrostrada**

IP66

SD DALI

P. 088

Exclusive Beghelli proposals

lighting



BEGHELLI NUBE CLOUD, THE RIGHT PLACE FOR YOUR SYSTEMS

NuBe is the unique WEB platform to **access and manage all Beghelli systems in the cloud**. Available to all Beghelli system installers and users, it allows you to manage and control **both normal lighting and emergency lighting**.

Among the many services offered, it will be possible to activate predictive maintenance, a function able to anticipate the user's maintenance interventions on the system to prevent malfunctions. It will also be possible to activate pre-programmed lighting scenarios, to switch on, switch off and dim groups of luminaires.



SD-X EXPANDABLE WITH AUTO-DIMMER

Luminaires equipped with the SD-X Smart Driver are set up for Autonomous operation. They can be connected to the SD LGFM Beghelli Control Unit by integrating the **optional Radio Module**. This version integrates 3 connectors: the first one is already connected to the Light Sensor of the Smart Dimmer for the **Auto-dimmer function**, the second is dedicated to the **PLUG&LIGHT emergency inverter**, and the third is reserved for one of the various optional communication modules, such as the Radio Module for connection to the Central Unit, the **Dali Module** or the **0÷10V Module** for interfacing with other communication BUS.



SD-RADIO ALSO INTEGRATES RADIO

The SD Radio range does not include any additional modules, but it integrates as standard the **SD Radio Interface**. It is therefore already prepared to activate the connection to the SD Logica LGFM Beghelli Control Unit.

This luminaire range integrates, where applicable, the smart dimmer light sensor.

This device makes the **Auto-dimmer function** always available to modulate the light intensity of each luminaire, calibrated according to the natural light in the room. The auto-dimmer is automatically activated as soon as the luminaire is installed.



The lighting version of the Cloud will be on-line from the second half of 2021



SMART DRIVERS WITH INTEGRATED AUTO-DIMMER

The entire SD range (where applicable) is equipped with an integrated driver and Auto-dimmer already configured in Natural Light mode, therefore able to automatically adjust the light intensity of the luminaire according to the amount of natural light in the environment. The radio link with the SD control unit also allows the user to set the desired dimming intensity as well as the activation of customised lighting scenarios, including automatic activation, with the integration of motion sensors.



AIR SANITISATION INTEGRATED IN THE LIGHTING

Hybrid luminaires for normal lighting with **integrated air sanitizer**. The sanitisation device is based on a closed chamber UV-C flow cell, without ozone emissions.

The system has adjustable speed and operating timing and, thanks to the exclusive **uvOxy®** technology, it eliminates any risk during operation and allows the **continuous sanitisation of rooms in the presence of people**. Performed tests are available online, and they certify a **sanitising efficacy of over 99%** against Coronavirus and bacteria far more aggressive than COVID-19.



AUTO-DIMMER
NATURAL LIGHT
30% more energy savings

SMART LIGHT SENSOR AUTO-DIMMER NATURAL LIGHT

Each luminaire equipped with a Smart Driver (SD-x or SD-RADIO), if suitable, integrates the Auto-dimmer smart light sensor that makes it autonomous in modulating the luminous flux. Lighting management is achieved by the **automatic adjustment of the light intensity according to the light already present in the room**.

The light sensor can measure the light on the work surface by modulating the power in order not to exceed the required lighting. With this technology, you can achieve **energy savings of up to more than 30%** compared to LED luminaires with fixed luminous intensity.



QUICK-CONNECT EMERGENCY INVERTER

Beghelli has a wide range of high performance LED inverters to **integrate emergency into all normal luminaires**. The **Plug&Light** version has a quick-connection system that allows **it to be installed in all SD-X luminaires without modification to the system**.

Unique connection system that ensures a remarkable speed of installation and, above all, the maintenance of the regulatory compliance characteristics of the luminaire on which it is installed.

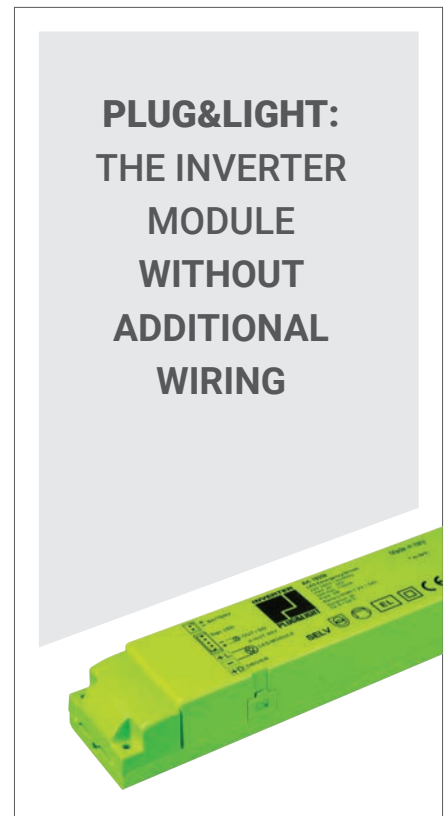





Control and communication systems

FROM STANDARD POWER SUPPLY TO CENTRALISED REMOTE CONTROL

Beghelli luminaires are available in different power supply and control modes.

SD-X, the most advanced driver version, also in terms of flexibility, thanks to the integrated auto-dimmer and the connection port with various expansion modules, can connect to the control unit and take on different configurations. **SD-RADIO** are devices equipped with an auto-dimmer and an integrated radio module for connection to the control unit. The **RD** driver allows adjustment on various steps for luminous flux regulation, **TR** is the standard version, while **DALI** are luminaires that can be interfaced with this system.

POWER SUPPLY AND CONTROL SYSTEMS	AUTO-DIMMER	FLUX ADJUSTMENT	CENTRALISED CONTROL	MAX. NUMBER OF LUMINAIRES PER CONTROL UNIT	RADIO COMMUNICATIONS
 SD-X	✓	✓	✓	Up to 996	Optional with module
 SD-RADIO	✓	✓	✓	Up to 996	✓
 RD - ADJUSTABLE		✓			
					* H-PRO only (0-10V)
 ED - STANDARD					
 DALI		✓	✓	Up to 64	

* H-PRO = Professional high bay light/floodlight page 078

SD DRIVERS, SMART LIGHTING

The integration of the SD Smart Driver marked a quantum leap in lighting systems, both in terms of flexibility and functional expandability. A driver specifically designed for industrial use (according to EN 61000-6-2), resistant to overvoltage pulses ≤ 4 Kvolt. The system can be equipped with an integrated radio transmitter (SD-RADIO) or optional (SD_X), depending on the version, for communications with the control unit. The SD-X version also allows the integration of additional Smart Modules, including the radio module for connection with the SD Logic Control Unit, which can be connected to the appropriate connector and housed inside the luminaire.



SMART MODULES THAT CAN BE CONNECTED TO THE SD-X DRIVER



both local and remote

THE EVOLUTION OF SYSTEMS IS ONE OF INTEGRATION AND SMART CONTROL

Beghelli's idea of a smart lighting system finds its maximum expression when the lighting is integrated with the emergency and the entire system can be managed and programmed remotely. For this purpose, the NuBe Cloud Portal was created, where all system data can be stored and checked at any time.



Internet connection from PC, tablet or smartphone to Beghelli NuBe Cloud portal for the control, programming and activation of luminaires or lighting scenarios

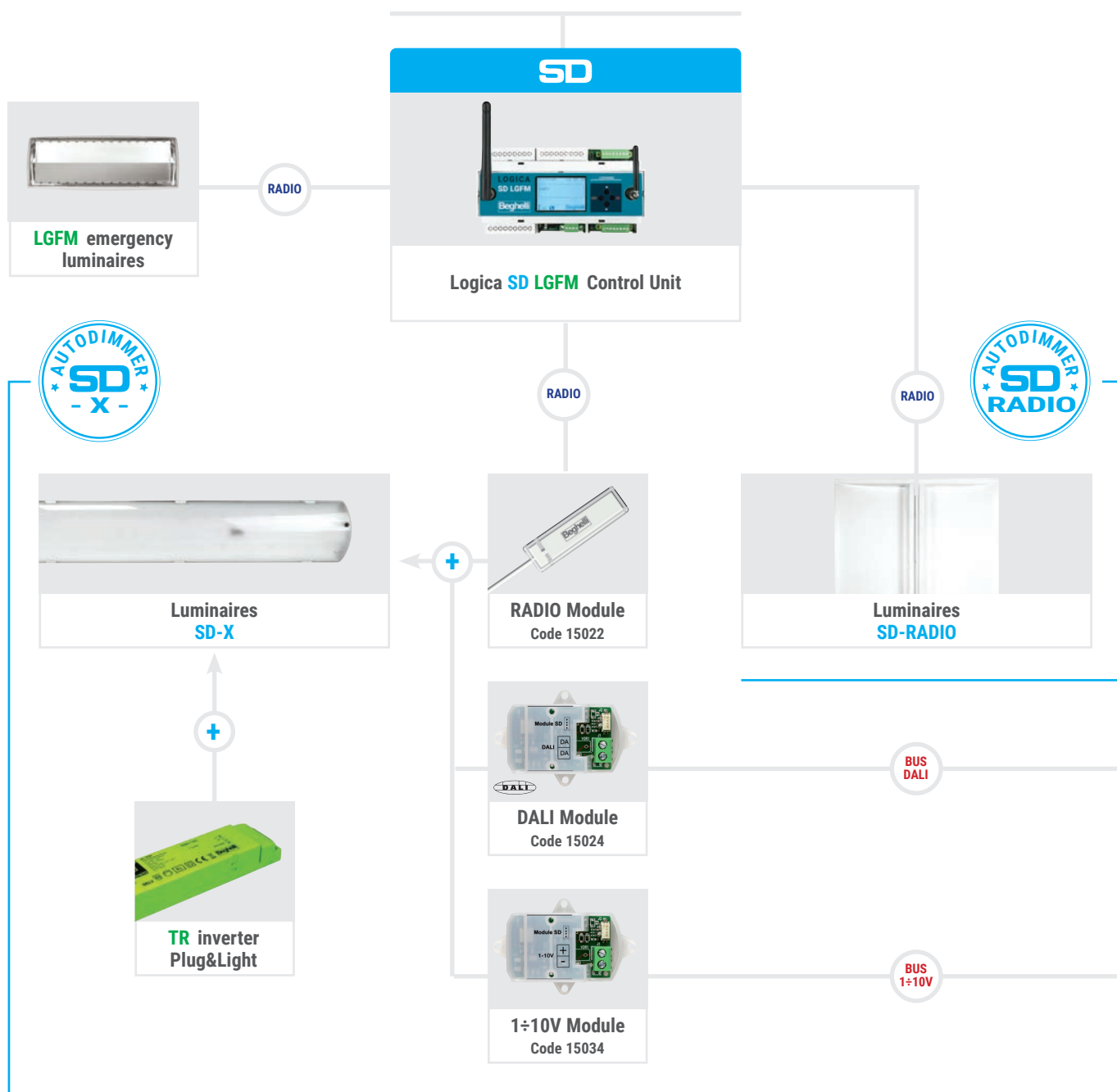

Logica SD LGFM Control Unit



Control unit for SD luminaires and LGFM emergency lighting, with radio control of the luminaires, integrated GSM module and WiFi for the remote management of the system.



Various types of connections possible and simultaneous management of lighting and emergency. Possibility of acting on each luminaire and creating or activating lighting scenarios. Secure radio transmission with a mesh communication network, where each luminaire acts as a repeater for the next luminaire.

Applications

Industry, services

Characteristics

Power supply 230VAC $\pm 10\%$, 50-60Hz

Mounting 9 DIN rail modules

Managed devices up to 996 radio devices that can be managed, including lighting, emergency and building automation devices; if more than one control unit is connected to the NuBe Cloud, the number of devices that can be managed is almost infinite

Connection interface

SFH DSSS Radio Spread Spectrum on 16 channels, UMTS 4G slot mini SD (SIM included), WiFi - AccesPoint (AP) mode and Client (STA) mode, Ethernet, USB (2 ports), Bluetooth, RS485, RS232, 4 x IN ports and 2 x OUT ports

Management software

B.connect App, NuBe, SD Manager, Logica visual

Memory card

SD Card (not included)

Compliance EN60950-1, EN62034, EN50172, 2014/53/EU

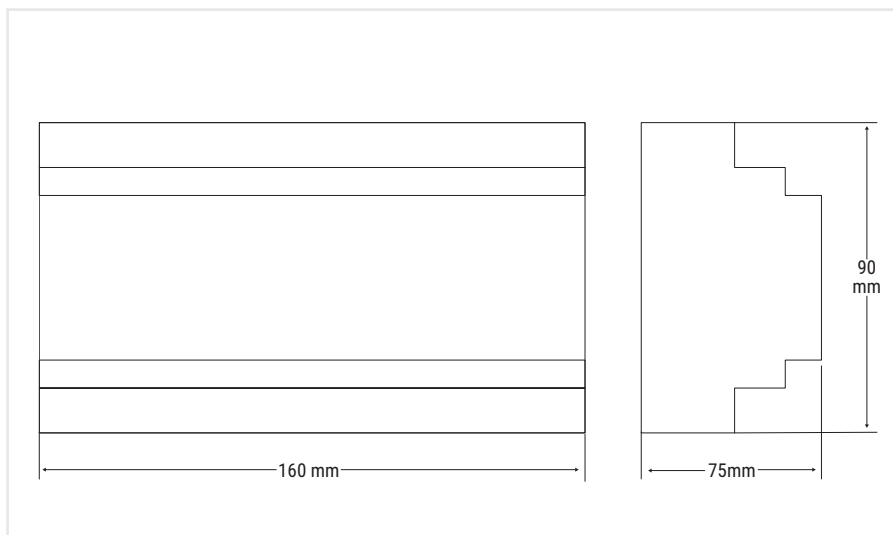

FUNCTIONS: Full control of the lighting system

- Switching on, switching off and dimming of luminaires.
- Management and timing of lighting scenarios in up to 256 luminaire groups.
- Setting of the operating mode (fixed brightness or with Auto-dimmer)
- Diagnostics
- Measurement of instantaneous power and energy consumption
- Compatibility with SD and LGFM emergency lighting systems
- Management of all functions of the emergency system of LGFM devices, as further specified in the emergency section (other side of the Reverso Catalogue)

SD MANAGER AND ON-LINE E-CATALOGUE FOR SETTING UP AND MANAGING LIGHTING SYSTEMS

SD manager is a software designed for the management of lighting and emergency lighting systems, capable of centralising all commands on a PC. The software, through the Logica SD LGFM Control Unit, can control the system, both to set the parameters of a new system and to set up an existing system with the creation of luminaire groups, lighting scenarios and the testing of any connected emergency system. It is also possible to position the luminaires on a plan in DWG format, on which you will have a complete overview of the system.

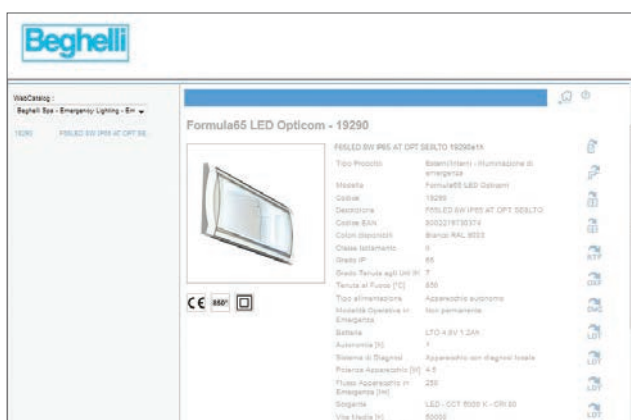
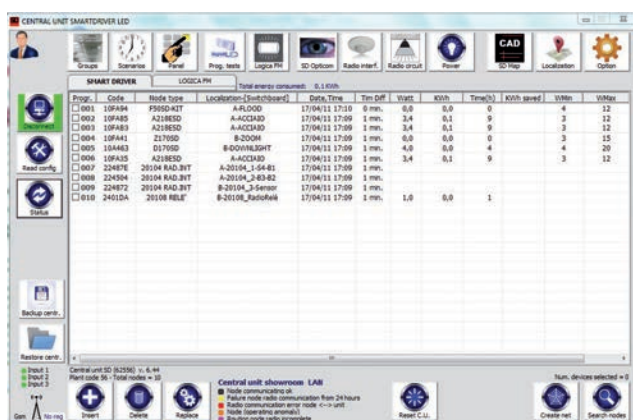

Screen shot with the SD Manager screen showing luminaires and system settings. Another screen allows the luminaires to be displayed on a DWG plan.

The e-catalogue on the beghelli.it website is always up-to-date so that you can check all the technical aspects of each luminaire and view the specific photometry values.



Order Code	Description	Number of luminaires	Number of DIN rail modules	Weight Kg	Packaging Single/Multi pack
 21102	SD LOGIC CONTROL UNIT (SIM included)	996	9	0.6	1

BUILDING AUTOMATION - included



SD MANAGER

Order Code **20109**



RS485/USB CABLE

(For order code 21102)



System modules



SMART DIMMER LIGHT SENSOR

Sensor consisting of a SMD light transistor, which can be connected to the SmartDriver electronic ballast to which it communicates the instantaneous reading of the contribution of daylight to the ambient lighting. This information allows the SmartDriver to correctly calibrate the power supply to the LEDs in order to maintain a constant and uniform lighting on work surfaces.

The Auto-dimmer sensor enables the luminaires on which it is installed to make consumption savings of 30% on an average.

Each luminaire, both SD-X and SD-RADIO, equipped with the new Smart Light Sensor, acquires the Auto-dimmer Natural Light function that allows reading the input of natural light in the environment and calibrating the artificial lighting.

Order code	Description	Packaging
15039	SMART DIMMER LIGHT SENSOR	1



∅ 50x45mm

OUTDOOR SMART DIMMER LIGHT SENSOR

Light sensor to be connected to the SmartDriver electronic ballast to activate the Auto-dimmer function in luminaires that do not have one or to dim groups of luminaires by centralising the reading of the ambient light via the SD Manager software. This device also allows correctly setting a uniform LED power, managing a single level of light intensity and maintaining constant and uniform lighting on worktops.

Order code	Description	Packaging
21100	OUTDOOR SMART DIMMER LIGHT SENSOR	1



33x52x28mm

DALI OR 1÷10V INTERFACE MODULES

Module with DALI port:

A device that can be connected directly to the SD-X Driver to control the luminaire. It also has a "Push to Dim" function, which switches the luminaire off, on and dims it by pressing buttons connected to it.

Module with 1-10V port:

The device enables the SD-X Driver to control the luminaire via a 1÷10V analogue interface.

Order code	Description	Packaging
15024	DALI MODULE	1
15034	1÷10V MODULE	1



BUILDING AUTOMATION RADIO MODULE

Spread spectrum radio transceiver operating in the 2,400-2,483 GHz band according to the Beghelli FH-DSSS protocol. The device enables wireless remote control, the SD-X driver of the luminaire in which it is inserted. The Building automation Radio Module is powered by the SmartDriver and enables the following functions:

- Receiving and implementation of radio commands from the SD-X driver to Control Unit
- Possibility to implement automatic dimming functions or to activate pre-set lighting scenarios via radio messages
- If the SD Logica Control Unit is present in the system, it is possible to manage and control the diagnostics of each individual luminaire remotely, via the NuBe Cloud.

Order code	Description	Packaging
15022	BUILDING AUTOMATION RADIO MODULE	1



BUILDING AUTOMATION RADIO TRANSMITTER

Radio interface device, powered at 230VAC, equipped with a 230V input that can send radio commands to groups of luminaires or individual luminaires equipped with a Building automation Radio Receiver, even without a Control Unit. There are 2 transmitters inside the module that can be used separately or by means of an up/down button to switch on, off or dim via radio the luminaire to which it is connected. The device works with any power supply, it has an antenna and can be mounted in any type of unshielded box or 503 box (it takes up the space of 1 module), and it can also function as an SD signal repeater.

Order code	Description	Packaging
20104	BUILDING AUTOMATION RADIO TRANSMITTER	1



BUILDING AUTOMATION RADIO RECEIVER

Radio interface device, powered at 230VAC, incorporating a relay that can drive luminaires and other electrical loads. The device has an antenna and can be inserted into any type of unshielded box or 503 box (it takes up the space of 1 single module)

Maximum controlled load 260W.

The Building automation Radio Receiver must be associated with one or more Radio Transmitters or a Logical SD Central Unit to implement the corresponding commands.

Order code	Description	Packaging
20108	BUILDING AUTOMATION REMOTE CONTROL RECEIVER	1

LED Panel RTI SanificaAria

lighting



Hybrid device with uvOxy® air sanitization. Adjusting parameters from the SanificaAria APP or from NuBe. HCL version with Colour Temperature (K) adjustment in fixed (CCT) or automatic mode.

Applications

Service sector, public sector, offices, schools

Characteristics

Power supply unit 230VAC ±10%, 50÷60Hz

Power supply - MTBF at 25°C 65,000h

Luminous flux retention at 25°C

>80,000÷120,000h (L80B20)

Colour stability 3 SDCM

Mounting Recessed on Module 600, suspended with the steel cables supplied

Body Pre-galvanised sheet metal RAL 9003 matt

Optics PMMA microstructured lens

Compliance EN60598-1, EN60598-2-22, EN62471 (photobiological risk-free), CAM Minimum Environmental Criteria according to DM 11.01.2017, EN60598-2-2, EN60335-2-65, ISO 15714, 2014/53/EU1

Specifications of the Air Sanitizer

Power supply unit 230VAC ±10%, 50÷60Hz

uvOxy® input power 60÷75 W

UV-C wavelength 254 nm

Sanitization flow rate 200 m³/h

UV-C power 48 W

UV-C radiation power 15 W

Sanitization speed 1-2-3 steps

Timing programmable

Recommended cartridge life 12 months

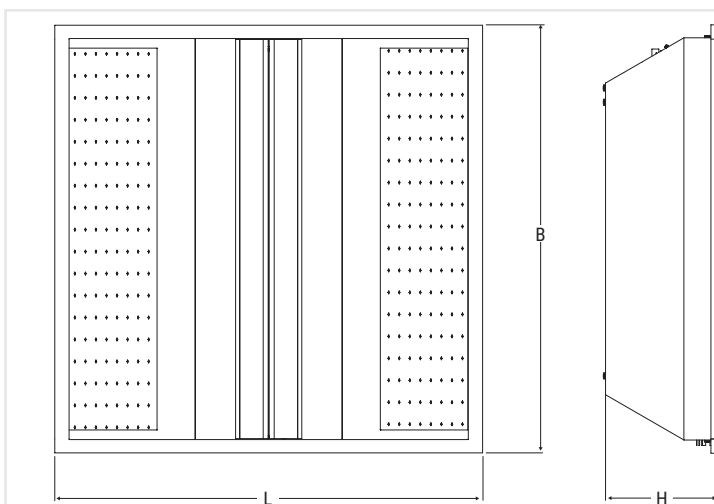

EXAMPLE OF SANITIZATION OF AIR IN AN ENVIRONMENT

Room size		
Volume m³	Surface area m²	Initial sanitization time h
110	40	0.5
200	75	1
320	120	1.5
430	160	2
650	240	3

Version	Dimensions mm		
	L	B	H
600x600	595	595	160

LED PANEL RTI SANIFICAARIA - 600x600

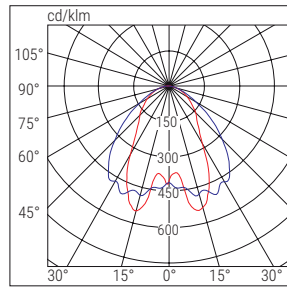

■ C90-C270 ■ C0-C180

	Order Code	Description	Power W	Colour temp. K	Chromatic yield	LED Flux lm (Tj=25°C)	Luminaire flux lm	Sanitisation flow rate m³/h			Brightness efficiency lm/W	Weight Kg	Packaging Single/ Multi pack	HCL CCT	
								1	2	3					
SD	40176UV	P RTI M600 35W U19C90 SDHCL UV	36	HCL 2700 ÷ 6000 CCT 2700-4000-6000	>90	6000	5000	100	150	200	140	7.5	1	GO*	AUTO-DIMMER
	40171UV	P RTI M600 35W U19C90 SD4K UV	36	4000	>90	6000	5000	100	150	200	140	7.5	1		
RD	40166UV	P RTI M600 35W U19C90 RDHCL UV	36	HCL 2700 ÷ 6000 CCT 2700-4000-6000	>90	6000	5000	100	150	200	139	7.5	1	GO*	ADJUSTABLE
	40161UV	P RTI M600 35W U19C90 RD4K UV	36	4000	>90	6000	5000	100	150	200	139	7.5	1		
DALI	MODULAR ENCODING: To create the DALI version device code, select a device in the range RD and add to its code the suffix DL Example: Order Code 40166UV + DL = Order Code 40166UVDL														DALI

	Flow rate up to 200 m³/h	Initial sanitisation time 15 minutes	Initial sanitisation time 40 minutes
	Performance related to a single system in an office of 20 sq m		Performance related to an open space with 1 device per 50 sq m



REMOTE SANITISATION MANAGEMENT, VIA SD LOGICA FM CONTROL UNIT, OR LOCALLY, WITH THE DEDICATED APP

With the integration of the SD Logica Control Unit, the sanitisation system can be connected to a network. The main parameters to regulate the system are the 3 levels of fan speed and the operating time. The system can be accessed from the NuBe portal to adjust all parameters, even remotely.



LOGICA SD LGFM CONTROL UNIT

Order Code **21102**

The Sanifica Aria Beghelli BLE APP (Bluetooth local remote control) has been designed to locally control the sanitisation system built into the luminaire, with the utmost simplicity. Using Bluetooth technology, the smartphone becomes a real remote control for the system, adjusting fan speed and setting the operating times of the air sanitizer.

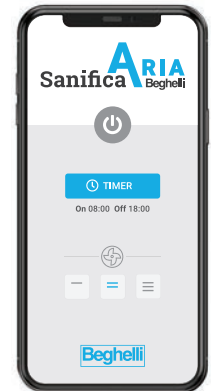

RD VERSIONS, WITH MANUALLY ADJUSTABLE FLUX/POWER IN 3 STEPS



Flux/Power	LED Panel RTI SanificaAria		
	lm	W	lm/W
STEP 1	5000	36	139
STEP 2	4000	28	142
STEP 3	3400	24	142

The lighting system must consider both the required level of lighting obtained from the lighting calculation and the power saving needs. LED Panel RTI SanificaAria allows you to achieve this result thanks to its driver with a 3-step current modulation switch that provides maximum luminous efficiency and, therefore, maximum power savings, while observing the luminous flux set out in the design phase.

NEXT >

LED Panel RTI SanificaAria

lighting

 **HCL-CCT module, both in SD and RD version, for automatic colour temperature variation according to the solar time or to set 2700, 4000, 6000K constants**

The HCL-CCT module equips both RD and SD series luminaires and allows a colour temperature adjustment in 3 steps 2700K - 4000K - 6000K (CCT). It also enables the automatic HCL (Human Centric Lighting - Biodynamic Lighting) mode, which adapts to the human biological cycle. To simply perform this function, a new preconfigured system has been developed, which takes care of the dynamic synchronisation of colour variation corresponding to the time of day with the human biological clock (circadian cycle). Each luminaire has a pre-set clock to synchronise the automatic cycle with the time of day as soon as the luminaire is connected: simply set the selector switch to HCL mode, the luminaire will recognise the time of day and provide the most suitable colour temperature. With the same selector, you can set the luminaire on the HCL or CCT mode (2700K - 4000K - 6000K) and, in the SD Auto-dimmer version, the light output also takes into account the natural light input in the room.

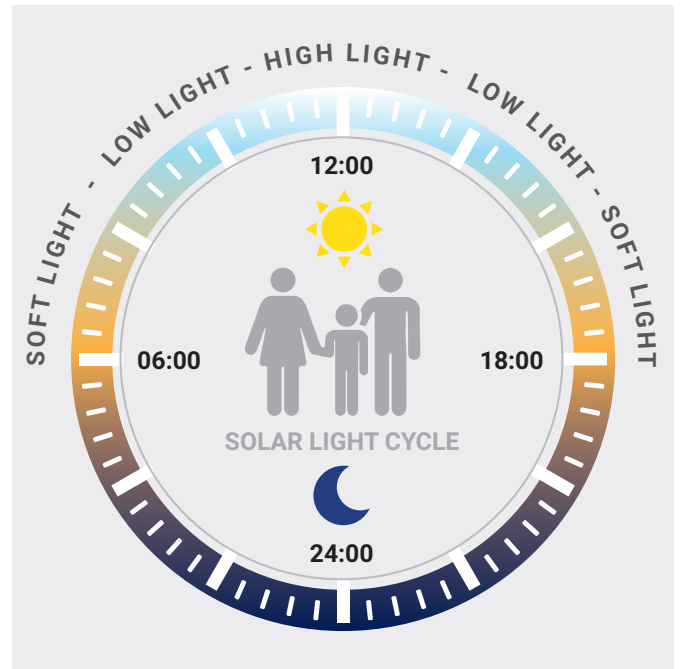

SPECIAL VARIANTS - on request

COLOUR TEMPERATURE 3000K and 6000K, 0-10V

ACCESSORIES - included



SD RADIO / 1 -10V INTERFACE

SD



SMART DIMMER LIGHT SENSOR

Order Code **15039**

SD

ACCESSORIES AND SPARE PARTS - to be ordered separately



SPARE PART PURIFICATION CARTRIDGE uvOxy®

Duration 12 months, at 24h/day use

Order Code **26721**



SanificaAria RADIO TRANSMITTER

Radio control via an external button, of one or more SanificaAria luminaires

Order Code **20104SA**

BUILDING AUTOMATION - to be ordered separately



LOGICA SD LGFM CONTROL UNIT

nuBe

SD

Order Code **21102**



BUILDING AUTOMATION RADIO TRANSMITTER

Order Code **20104**

SD

EMERGENCY LED INVERTERS - to be ordered separately



INVERTER PLUG&LIGHT SE/SA 1-3h 20-60V

Order Code **19358** (1h)

Order Code **19359** (3h)

TR



INVERTER GL AT/LG AR 15W 55V

Order Code **19391** (LiFe battery)

Order Code **19390** (LTO battery)

AT LG



INVERTER AT/LG AR 9W 55V

Order Code **19355L** (LiFe battery)

AT LG



LGFM EMERGENCY MODULE

For AT/LG series inverters only

Order Code **19375**

LGFM



015 hybrid luminaires with air sanitizer

Modulo 600 SanificaAria

lighting



Recessed device for uvOxy® air sanitization. Adjusting parameters from the SanificaAria APP or from NuBe.

Device without a light source, to be used for sanitizing rooms only. Designed for integrating the uvOxy® air sanitization system in a new or existing lighting system.

It can be installed on a support on false ceilings made of Modulo 600 structures.

Applications

Service sector, public sector, offices, schools

Specifications of the Air Sanitizer

Power supply unit 230VAC ±10%, 50÷60Hz

Mounting Recessed on Module 600, suspended with the steel cables supplied

Body Pre-galvanised sheet metal RAL 9003 matt

uvOxy® input power 60÷75 W

UV-C wavelength 254 nm

Sanitization flow rate 200 m³/h

UV-C power 48 W

UV-C radiation power 15 W

Sanitization speed 1-2-3 steps

Timing Programmable

Cartridge life 12 months

Compliance EN60335-2-65, ISO 15714

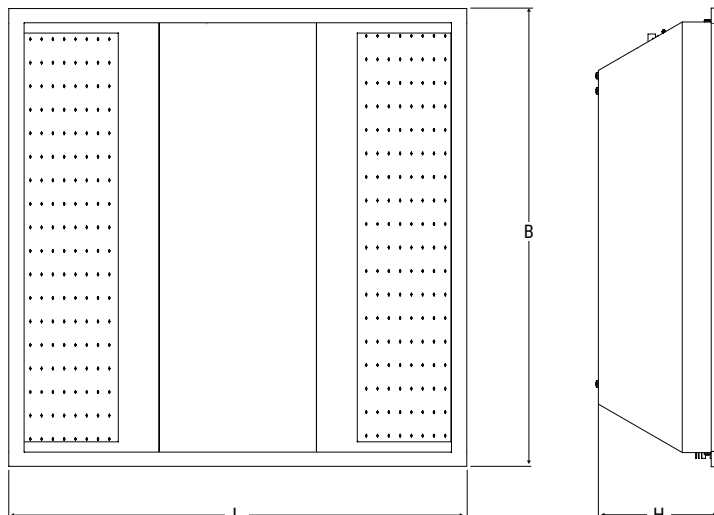

EXAMPLE OF SANITIZATION OF AIR IN AN ENVIRONMENT

Room size		
Volume m³	Surface area m²	Initial sanitization time h
110	40	0.5
200	75	1
320	120	1.5
430	160	2
650	240	3

Version	Dimensions mm		
	L	B	H
600x600	595	595	160

Order Code	Description	Power W	Sanitisation flow rate m ³ /h			Weight Kg	Packaging Single/Multi pack
			1	2	3		
26706	SANIFICA ARIA MODULE 600	36÷60 W	100	150	200	7.5	1

	Flow rate up to 200 m ³ /h	Initial sanitisation time 15 minutes	Initial sanitisation time 40 minutes
	Performance related to a single system in an office of 20 sq m		Performance related to an open space with 1 device per 50 sq m

REMOTE SANITISATION MANAGEMENT, VIA SD LOGICA FM CONTROL UNIT, OR LOCALLY, WITH THE DEDICATED APP

With the integration of the SD Logica Control Unit, the sanitisation system can be connected to a network. The main parameters to regulate the system are the 3 levels of fan speed and the operating time. The system can be accessed from the NuBe portal to adjust all parameters, even remotely.

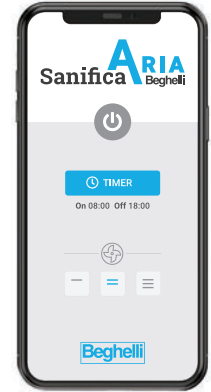

The Sanifica Aria Beghelli BLE APP (Bluetooth local remote control) has been designed to locally control the sanitisation system built into the luminaire, with the utmost simplicity. Using Bluetooth technology, the smartphone becomes a real remote control for the system, adjusting fan speed and setting the operating times of the air sanitizer.





LOGICA SD LGFM CONTROL UNIT

Order Code **21102**

ACCESSORIES AND SPARE PARTS - to be ordered separately



SPARE PART PURIFICATION CARTRIDGE uvOxy®

Duration 12 months, at 24h/day use

Order Code **26721**



SanificaAria RADIO TRANSMITTER

Radio control via an external button, of one or more SanificaAria luminaires

Order Code **20104SA**



017 hybrid luminaires with air sanitizer

LED Panel RTI



- IP20
IP40
- IK05
- ∧ 960°
-
- 🌡️ +40°C
-20°C
- CRI>90
- UGR<19
- FLICKER FREE



Higher quality light diffusion LED panel, made of **90% less plastic** in an environmentally friendly way.



It allows multiple types of mounting and the adjustment of colour temperature (K) in fixed mode (CCT) or automatic mode (HCL).



Micro-structured lens for soft and diffused, direct and indirect light.



Built-in universal bracket for ceiling (without an additional frame) or recessed mounting.

Applications

Services, public sector, offices, schools

Characteristics

Power supply

SD 230VAC ±10%, 50÷60Hz, 168÷280VDC

ED 230VAC ±10%, 50÷60Hz

Power supply - MTBF at 25°C 65,000h

Luminous flux retention at 25°C

>80,000÷120,000h (L80B20)

Colour stability 3 SDCM

Mounting M600, ceiling, suspended

Housing Polyester powder-coated pre-galvanised sheet steel, RAL 9003, matt

Optics PMMA micro-structured lens

Compliance EN60598-1, EN60598-2-2, EN60598-2-22, EN62471 (photobiological risk-free), CAM Minimum Environmental Criteria according to DM 11.01.2017, 2014/53/EU

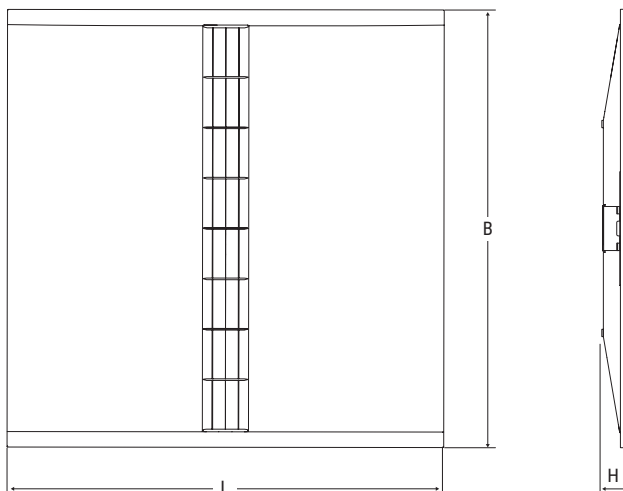

Order code	Dimensions mm		
	L	B	H
40151	595	595	34
40161, 40171, 40166, 40176	595	595	51
40154, 40157	295	1195	34
40164, 40168, 40174, 40178, 40167, 40177, 40181	295	1195	51

LED PANEL RTI - 600x600

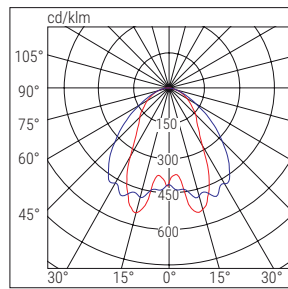

■ C90-C270 ■ C0-C180

LED PANEL RTI - 300x1200

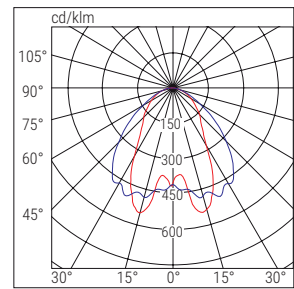

■ C90-C270 ■ C0-C180

	Version	Order Code	Description	Power W	Colour temp. K	Chromatic yield	LED Flux lm (Tj=25°C)	Luminaire flux lm	Brightness efficiency lm/W	Weight Kg	Packaging Single/ Multi pack	HCL CCT
SD	600x600	40171	PAN RTI M600 35W U19C90 SD4K	36	4000	>90	6000	5000	139	2.5	1/4	
	300x1200	40174	PAN RTI 30x120 35W U19C90 SD4K	35	4000	>90	6000	5000	143	3.9	1/4	
	300x1200	40181	PAN RTI 30x120 50W U19C90 SD4K	50	4000	>90	8400	7000	140	3.9	1/4	
	600x600	40176	PAN RTI M600 35W U19C90 SD HCL	36	HCL 2700 ÷ 6000 CCT 2700-4000-6000	>90	6000	5000	139	2.6	1/4	☀️ 🌙
	300x1200	40177	PAN RTI 30x120 35W U19C90 SD HCL	35	HCL 2700 ÷ 6000 CCT 2700-4000-6000	>90	6000	5000	143	4.0	1/4	☀️ 🌙
	300x1200	40178	PAN RTI 30x120 50W U19C90 SD HCL	50	HCL 2700 ÷ 6000 CCT 2700-4000-6000	>90	8400	7000	140	4.0	1/4	☀️ 🌙
ED	600x600	40151	PAN RTI M600 25W U19C90 ED4K	24	4000	>90	4000	3400	142	1.9	1/6	
	300x1200	40154	PAN RTI 30x120 25W U19C90 ED4K	23	4000	>90	4000	3400	148	2.7	1/6	
	300x1200	40157	PAN RTI 30x120 50W U19C90 ED4K	48	4000	>90	8200	6800	142	2.7	1/6	
	600x600	40161	PAN RTI M600 35W U19C90 ED4K	36	4000	>90	6000	5000	139	2.4	1/4	
	300x1200	40164	PAN RTI 30x120 35W U19C90 ED4K	35	4000	>90	6000	5000	143	3.8	1/4	
	600x600	40166	PAN RTI M600 25W U19C90 HCL	25	HCL 2700 ÷ 6000 CCT 2700-4000-6000	>90	4200	3500	140	2.5	1/4	☀️ 🌙
	300x1200	40167	PAN RTI 30x120 25W U19C90 HCL	24	HCL 2700 ÷ 6000 CCT 2700-4000-6000	>90	4200	3500	146	3.9	1/4	☀️ 🌙
	300x1200	40168	PAN RTI 30x120 50W U19C90 HCL	50	HCL 2700 ÷ 6000 CCT 2700-4000-6000	>90	8400	7000	140	3.9	1/4	☀️ 🌙
DALI	MODULAR ENCODING: To create the DALI version device code, select a device in the range ED and add to its code the suffix DL Example: Order Code 40157 + DL = Order Code 40157DL											

☀️🌙 HCL-CCT module, both in SD and ED version, for automatic colour temperature variation according to the solar time or to set 2700, 4000, 6000K constants

The HCL-CCT module allows you to adjust the colour temperature in 3 steps 2700K - 4000K - 6000K (CCT) that can also be activated in HCL (Human Centric Lighting) mode, with automatic light variations, to adapt the lighting to the human biological cycle (biodynamic lighting). A pre-set clock, built-in in each luminaire, deals with the synchronisation of colour variations according to the hour of the solar day, to provide the most suitable colour temperature (K). With the same selector, you can set the luminaire on HCL mode, with controlled colour variations, or on CCT mode, by setting a fixed chosen value (2700K - 4000K - 6000K). In addition, in the SD Auto-dimmer version, the light output also takes into account the existing supply of natural light.

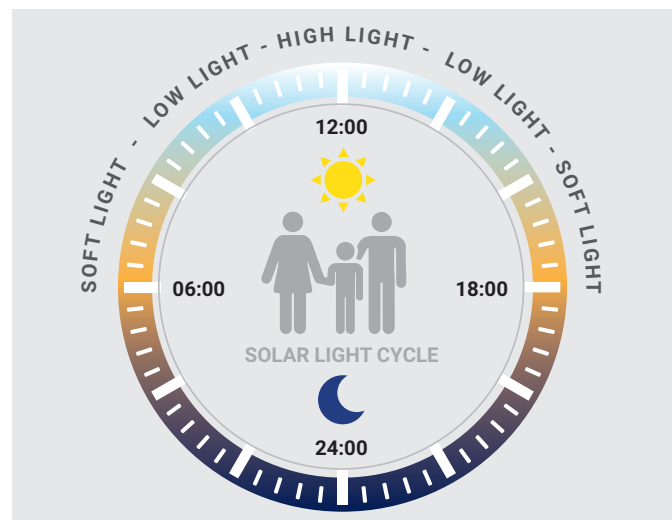

NEXT >

019 recessed

LED Panel RTI

SPECIAL VARIANTS - on request

COLOUR TEMPERATURE 3000K and 6000K, 0-10V

ACCESSORIES - included



SD RADIO / 1 -10V INTERFACE

SD



SMART DIMMER LIGHT SENSOR

Order Code **15039**

SD



CEILING MOUNTING BRACKET
Supplied on all models

ACCESSORIES - to be ordered separately



INVERTER MOUNTING BRACKET
Only for Order Codes 40151, 40154, 40157

Order Code **40190** (600x600) - **40191** (300x1200)



SUSPENDED MOUNTING KIT

Order Code **70033**

BUILDING AUTOMATION - to be ordered separately



LOGICA SD LGFM CONTROL UNIT

Order Code **21102**

SD



BUILDING AUTOMATION RADIO TRANSMITTER

Order Code **20104**

SD

EMERGENCY LED INVERTERS - to be ordered separately

LUMINAIRE/INVERTER COMPATIBILITY ACCORDING TO THE TYPE OF MOUNTING			
LUMINAIRES Order Code	COMPATIBLE INVERTERS	TYPE OF MOUNTING	MOUNTING ACCESSORIES
40151	19367 - 19371	M600	Bracket Code 40190
		ceiling/suspended	
40154 40157	19367 - 19371	M600	Bracket Code 40191
		ceiling/suspended	
40161	19358 - 19359- 19355L 19390 - 19391	M600	
		ceiling/suspended	
40164	19358 - 19359- 19355L 19390 - 19391	M600	
		ceiling/suspended	
40166	19367 - 19371	M600	
		ceiling/suspended	
40167	19367 - 19371	M600	
		ceiling/suspended	
40176	19358 - 19359	M600	on request
		ceiling/suspended	
	19355L - 19390 - 19391	M600	Inverter Cover IP65 Code 19376 on request
40177 40178 40168	19358 - 19359- 19355L 19390 - 19391	M600	
		ceiling/suspended	
40171	19358 - 19359	M600	on request
		ceiling/suspended	
	19355L 19390 - 19391	M600	Inverter Cover IP65 Code 19376 on request
		ceiling/suspended	
40174 40181	19358 - 19359- 19355L 19390 - 19391	M600	
		ceiling/suspended	



INVERTER PLUG&LIGHT SE/SA 1-3h 20-60V

Order Code **19358** (1h)
Order Code **19359** (3h)

TR



INVERTER PLUG&LIGHT SE/SA 1-3h 60-180V

Order Code **19367** (1h)
Order Code **19371** (3h)

TR



INVERTER AT/LG AR 9W 55V

Order Code **19355L** (LiFe battery)

AT LG



INVERTER GL AT/LG AR 15W 55V

Order Code **19391** (LiFe battery)
Order Code **19390** (LTO battery)

AT LG



LGFM EMERGENCY MODULE
For LG series inverters only

Order Code **19375**

LGFM





INVERTER COVER

Order Code **19376**

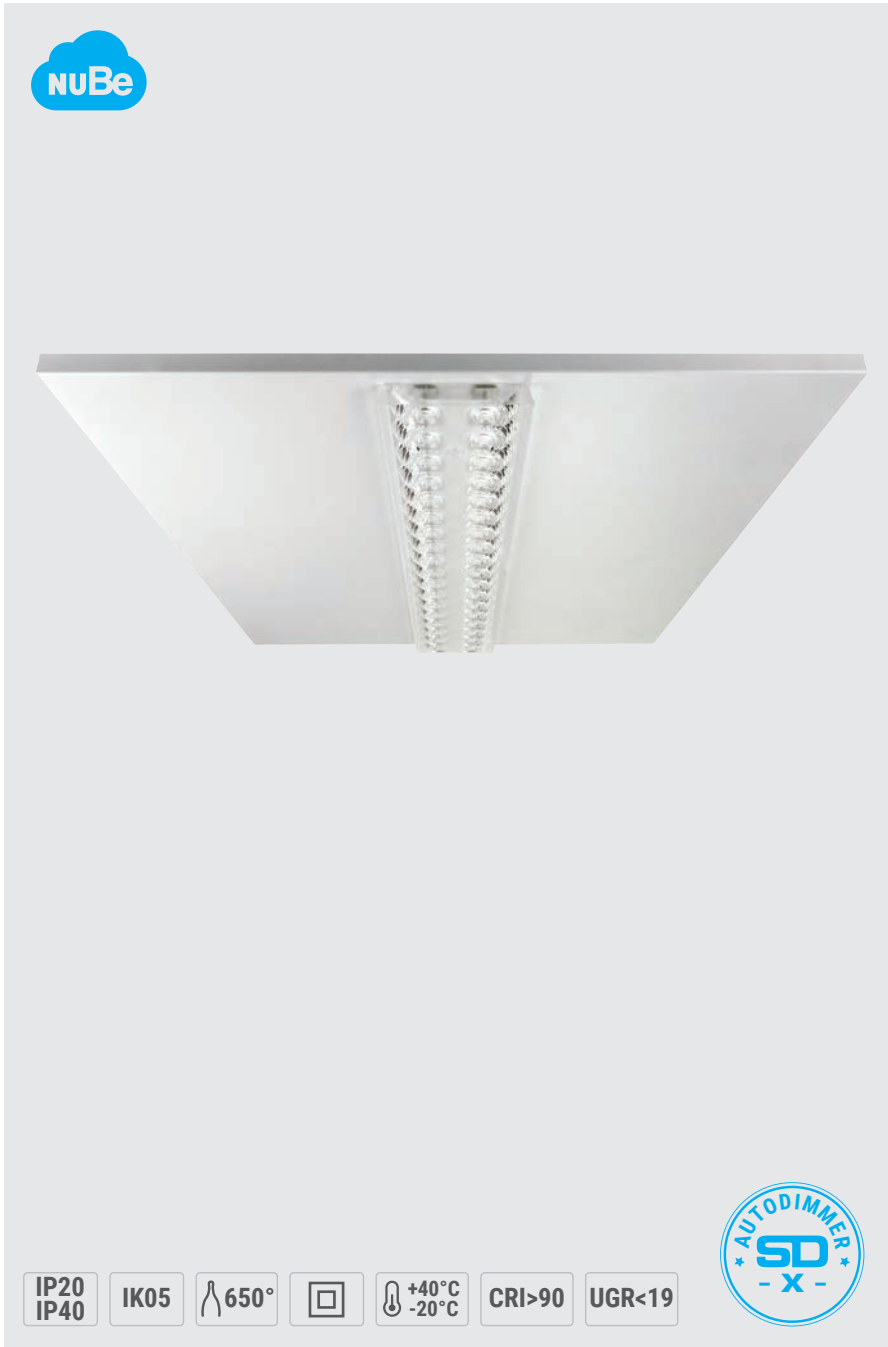

Lens Panel



 Brightness efficiency of more than 130lm/W with a flux of up to 7000lm.

 Anti-glare multi-lens optics (UGR<19). Colour rendering index Ra>90 to faithfully render the colours of an illuminated object.

 Ceiling mounting with reduced thickness, the ED version does not require accessories.

Applications

Services, retail, offices, schools, hospitals

Characteristics

Power supply

SD Universal Multi Voltage

93÷265VAC, 50÷60Hz, 176÷250VDC

ED 230VAC ±10% 50Hz

Power supply - MTBF at 25°C 80,000h

Luminous flux retention at 25°C

60,000h (L80B20)

Colour stability 3 SDCM

Mounting recessed, M600, ceiling, suspended

Housing Polyester powder-coated pre-galvanised sheet steel, RAL 9003

Optics Clear PMMA lenses

Compliance EN 60598-1, EN60598-2-2, EN 60598-2-22, EN62471 (photobiological risk-free), CAM Minimum Environmental Criteria according to DM 11.01.2017, 2014/53/EU

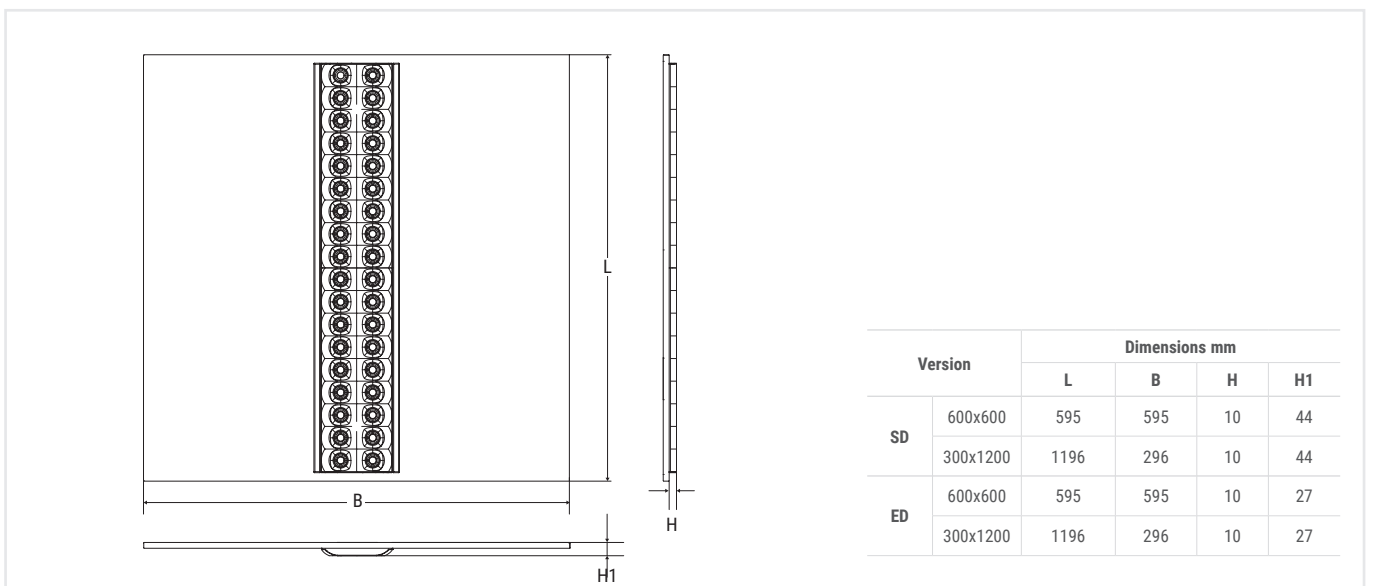

Version		Dimensions mm			
		L	B	H	H1
SD	600x600	595	595	10	44
	300x1200	1196	296	10	44
ED	600x600	595	595	10	27
	300x1200	1196	296	10	27

LENS PANEL - 600x600

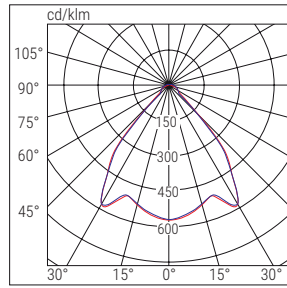

■ C0-C180 ■ C90-C270

LENS PANEL - 300x1200

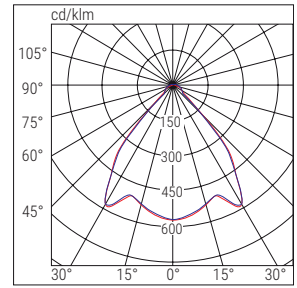

■ C0-C180 ■ C90-C270

	Version	Order Code	Description	Power W	Colour temp. K	Chromatic yield	LED Flux lm (Tj=25°C)	Luminaire flux lm	Brightness efficiency lm/W	Weight Kg	Packaging Single/ Multi pack	Notes	
SD	600x600	40140	LENS PAN 418 M600 UGR19 CRI90 SD 4K	35	4000	>90	4700	4400	126	3.5	1/3	☐	AUTO-DIMMER
	300x1200	40143	LENS PAN 236 300x1200 UGR19 CRI90 SD4K	41	4000	>90	6100	5300	129	3.5	1/3	☐	
	300x1200	40146	LENS PAN 258 300x1200 UGR19 CRI90 SD4K	56	4000	>90	7500	7000	125	3.5	1/3	☐	
ED	600x600	40131	LENS PAN 418 M600 UGR19 CRI90 ED4K	25	4000	>90	3700	3400	136	3.5	1/3		ON / OFF
	300x1200	40134	LENS PAN 236 300x1200 UGR19 CRI90 ED4K	32	4000	>90	5400	4500	141	3.5	1/3		
	300x1200	40137	LENS PAN 258 300x1200 UGR19 CRI90 ED4K	50	4000	>90	7100	6500	130	3.5	1/3		
DALI	INTERFACING WITH ACCESSORY TO BE ORDERED SEPARATELY: It is possible to create DALI luminaires by integrating the version SD with the accessory Dali Module Order Code 15024 Example: Order Code 40146 + 15024 = Luminaire 40146 in the DALI version												DALI

ACCESSORIES - included



SMART DIMMER LIGHT SENSOR

Order Code **15039**



ACCESSORIES - to be ordered separately



SUSPENDED MOUNTING KIT

Order Code **70033**

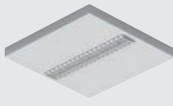

CEILING FRAME

SD versions only or combined with the Plug&Light inverter

Order Code **20089** (600x600)

Order Code **20101** (300x1200)

Lens Panel

lighting

BUILDING AUTOMATION - to be ordered separately



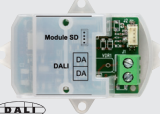

LOGICA SD LGFM CONTROL UNIT 

Order Code **21102** 



DALI MODULE

Order Code **15024** 



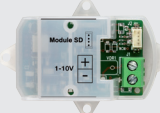

BUILDING AUTOMATION RADIO TRANSMITTER

Order Code **20104** 



1-10V MODULE

Order Code **15034** 



BUILDING AUTOMATION RADIO MODULE

Order Code **15022** 

EMERGENCY LED INVERTERS - to be ordered separately





INVERTER PLUG&LIGHT SE/SA 1-3h 20-60V

Order Code **19358** (1h)
Order Code **19359** (3h) 



LGFM EMERGENCY MODULE
For AT/LG series inverters only

Order Code **19375** 





INVERTER AT/LG AR 9W 55V
Inverter cover (19376) required for installation

Order Code **19355L** (LiFe battery) 



INVERTER COVER IP65

Order Code **19376** 



INVERTER GL AT/LG AR 15W 55V
Inverter cover (19376) required for installation

Order Code **19391** (LiFe battery)
Order Code **19390** (LTO battery) 



025 recessed

Led Panel IP65



IP65 LED panel with high LED efficiency of up to over 110 lm/W. Colour rendering index CRI>90, minimal body thickness (9mm).



Anti-glare micro-prismatic screen UGR<19.

Applications

Services, retail, offices, schools, hospitals

Characteristics

Power supply

SD 93÷265VAC, 50÷60Hz, 176÷250VDC

ED 230VAC ±10%, 50Hz

Power supply - MTBF at 25°C 65,000h

Luminous flux retention at 25°C
>50,000h (L80B20)

Colour stability 3 SDCM

Mounting recessed, M600

Housing Aluminium, white

Optics UV-stabilised, self-extinguishing, micro-prismatic screen, anti-reflective, PMMA light guide

Compliance EN60598-1, EN60598-2-2, EN60598-2-22, EN62471 (photobiological risk-free), CAM Minimum Environmental Criteria according to DM 11.01.2017, 2014/53/EU

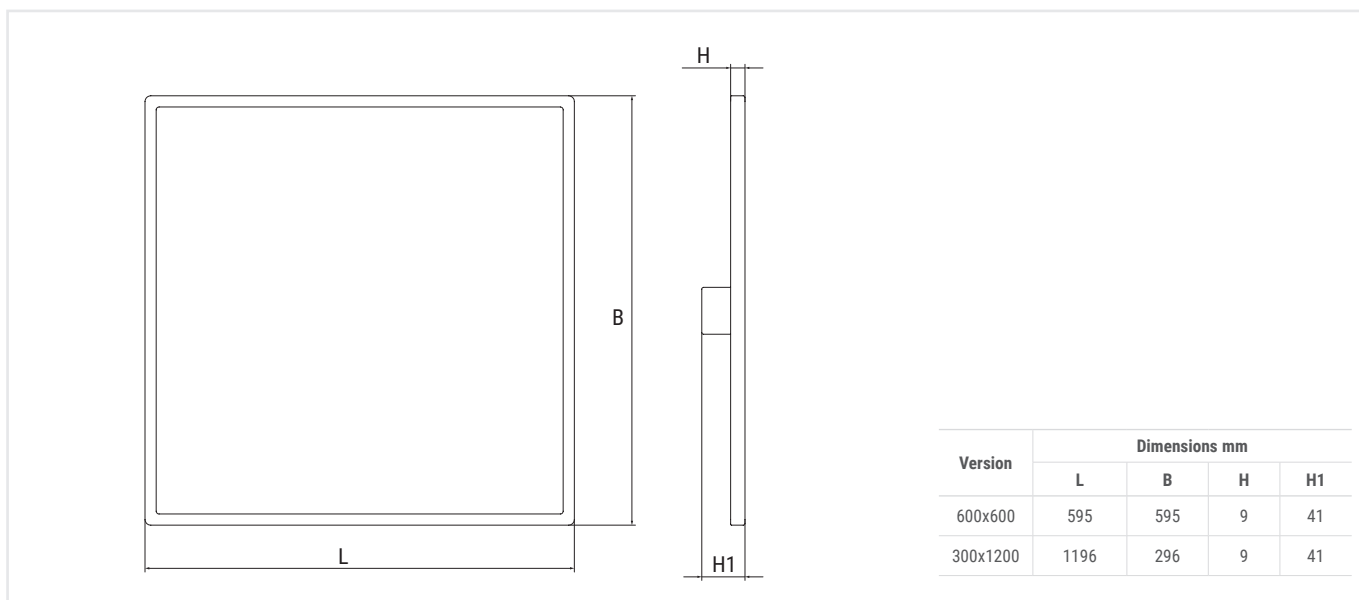

LED PANEL IP65 - 600x600

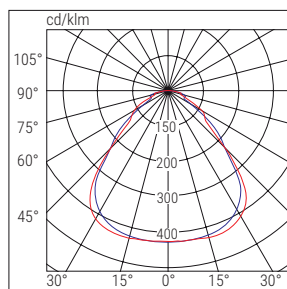

■ C90-C270 ■ C0-C180

LED PANEL IP65 - 300x1200

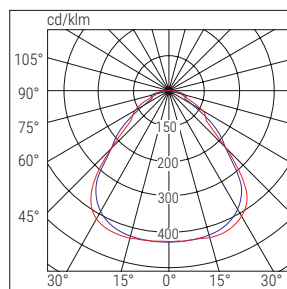

■ C90-C270 ■ C0-C180

	Version	Order Code	Description	Power W	Colour temp. K	Chromatic yield	LED Flux lm (Tj=25°C)	Luminaire flux lm	Brightness efficiency lm/W	Weight Kg	Packaging Single/Multi pack	
SD	600x600	40119	LED PANEL 418 M600 U19 C90 SD 4K IP65	36	4000	>90	4800	4000	110	3.5	1	AUTO-DIMMER (*)
	300x1200	40122	LED PANEL 30X120 U19 C90 SD 4K IP65	36	4000	>90	4800	4000	110	4.9	1	
ED	600x600	40113	LED PANEL M600 U19 C90 ED 4K IP65	36	4000	>90	4800	4000	110	3.5	1	ON / OFF
	300x1200	40116	LED PANEL 30X120 U19 C90 ED 4K IP65	36	4000	>90	4800	4000	110	4.9	1	

DALI **INTERFACING WITH ACCESSORY TO BE ORDERED SEPARATELY:**
 It is possible to create DALI luminaires by integrating the version **SD** with the accessory **Dali Module** Order Code **15024**
 Example: Order Code **40119+ 15024** = Luminaire **40119** in the DALI version **DALI**

(*) Function that can be activated by integrating the optional external light sensor Code 21100

BUILDING AUTOMATION - to be ordered separately



LOGICA SD LGFM CONTROL UNIT  

Order Code **21102**



OUTDOOR SMART DIMMER LIGHT SENSOR 

Order Code **21100**



BUILDING AUTOMATION RADIO MODULE 

Order Code **15022**

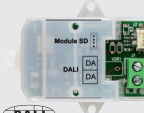

DALI MODULE 

Order Code **15024**



BUILDING AUTOMATION RADIO TRANSMITTER 

Order Code **20104**

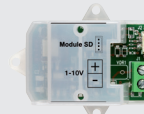



1-10V MODULE 

Order Code **15034**

EMERGENCY LED INVERTERS - to be ordered separately



INVERTER PLUG&LIGHT SE/SA 1-3h 20-60V IP65  

Order Code **19368** (3h)



LGFM EMERGENCY MODULE
For AT/LG series inverters only 

Order Code **19375**



INVERTER AT/LG AR 9W 55V
Inverter cover (19376) required for installation  



Order Code **19355L** (LiFe battery)



INVERTER COVER IP65 

Order Code **19376**



INVERTER GL AT/LG AR 15W 55V
Inverter cover (19376) required for installation
Order Code **19391** (LiFe battery)
Order Code **19390** (LTO battery)  

027 recessed

Led Panel

lighting



High LED efficiency of up to more than 110 lm/W. Colour rendering index CRI>90, minimum body thickness (9mm)



Both recessed and ceiling mounting with ceiling frame adapter, to be ordered separately



Anti-glare micro-prismatic screen UGR<19

Applications

Services, retail, offices, schools

Characteristics

Power supply

SD 93÷265VAC, 50÷60Hz, 176÷250VDC

ED 230VAC ±10% 50Hz

Power supply - MTBF at 25°C 65,000h

Luminous flux retention at 25°C

>50,000h (L80B20)

Colour stability 3 SDCM

Mounting recessed, M600, ceiling, suspended, plasterboard

Housing Aluminium, white

Optics UV-stabilised, self-extinguishing, micro-prismatic screen, anti-reflective, PMMA light guide

Compliance EN60598-1, EN60598-2-2, EN60598-2-22, EN62471 (photobiological risk-free), CAM Minimum Environmental Criteria according to DM 11.01.2017, 2014/53/EU

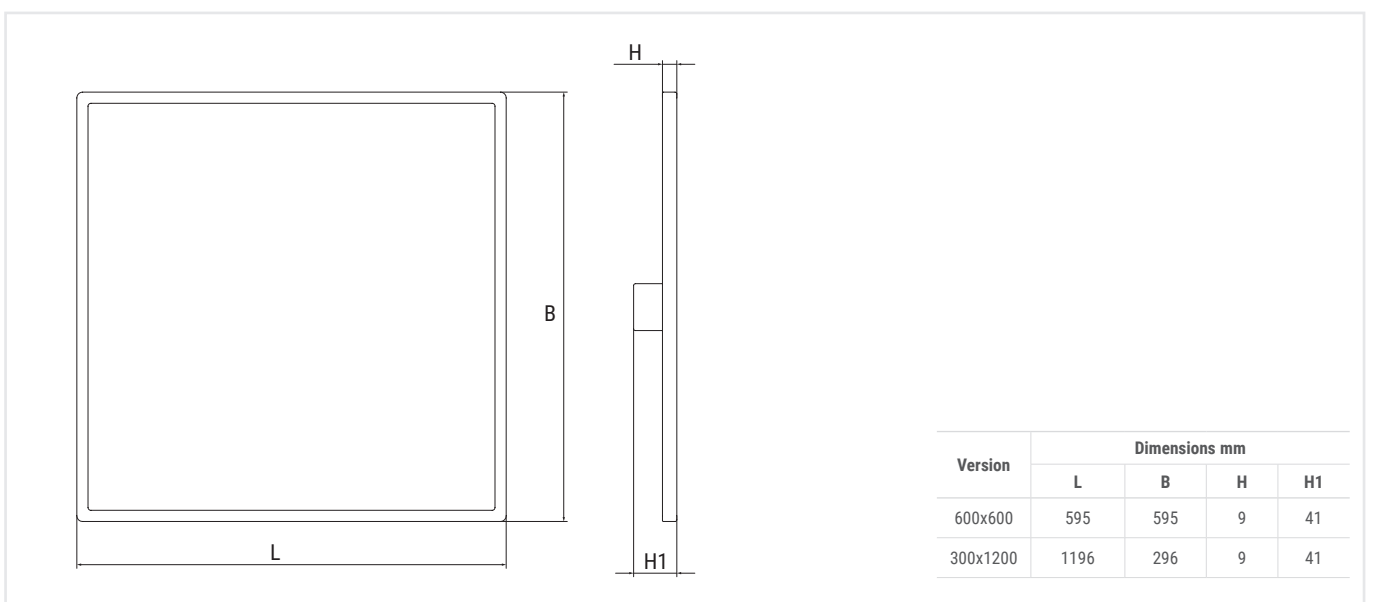

LED PANEL - 600x600

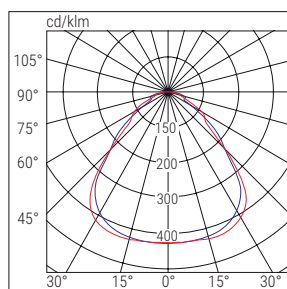

■ C90-C270 ■ C0-C180

LED PANEL - 300x1200

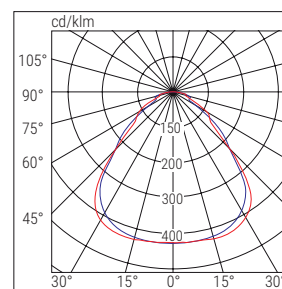

■ C90-C270 ■ C0-C180

	Version	Order Code	Description	Power W	Colour temp. K	Chromatic yield	LED Flux lm (Tj=25°C)	Luminaire flux lm	Brightness efficiency lm/W	Weight Kg	Packaging Single/ Multi pack	
SD	600x600	40107	LED PANEL 418 M600 U19 C90 SD 4K	36	4000	>90	4800	4000	110	3.5	1/5	AUTO-DIMMER
	300x1200	40110	LED PANEL 30X120 U19 C90 SD 4K	36	4000	>90	4800	4000	110	4.9	1/5	
ED	600x600	40101	LED PANEL 418 M600 U19 C90 ED 4K	36	4000	>90	4800	4000	110	3.5	1/5	ON / OFF
	300x1200	40104	LED PANEL 30X120 U19 C90 ED 4K	36	4000	>90	4800	4000	110	4.9	1/5	

DALI **INTERFACING WITH ACCESSORY TO BE ORDERED SEPARATELY:**
 It is possible to create **DALI** luminaires by integrating the version **SD** with the accessory **Dali Module** Order Code **15024**
 Example: Order Code **40107+ 15024** = Luminaire **40107** in the **DALI** version **DALI**

ACCESSORIES - included



SMART DIMMER LIGHT SENSOR

Order Code **15039**



ACCESSORIES - to be ordered separately



SUSPENDED MOUNTING KIT

Order Code **70033**

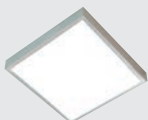

CEILING FRAME

Order Code **20097** (600x600)
 Order Code **20100** (1200x300)



PLASTERBOARD BRACKETS

4 pieces

Order Code **70048**













Led Panel

lighting

BUILDING AUTOMATION - to be ordered separately

	<p>LOGICA SD LGFM CONTROL UNIT </p> <p>Order Code 21102 </p>		<p>DALI MODULE</p> <p>Order Code 15024 </p>
	<p>BUILDING AUTOMATION RADIO MODULE</p> <p>Order Code 15022 </p>		<p>1÷10V MODULE</p> <p>Order Code 15034 </p>
	<p>BUILDING AUTOMATION RADIO TRANSMITTER</p> <p>Order Code 20104 </p>		

EMERGENCY LED INVERTERS - to be ordered separately

	<p>INVERTER PLUG&LIGHT SE/SA 1-3h 20-60V</p> <p>Order Code 19358 (1h) Order Code 19359 (3h) </p>		<p>LGFM EMERGENCY MODULE For AT/LG series inverters only</p> <p>Order Code 19375 </p>
	<p>INVERTER AT/LG AR 9W 55V Inverter cover (19376) required for installation</p> <p>Order Code 19355L (LiFe battery)  </p>		<p>INVERTER COVER IP65</p> <p>Order Code 19376 </p>
	<p>INVERTER GL AT/LG AR 15W 55V Inverter cover (19376) required for installation</p> <p>Order Code 19391 (LiFe battery) Order Code 19390 (LTO battery)  </p>		



I 418

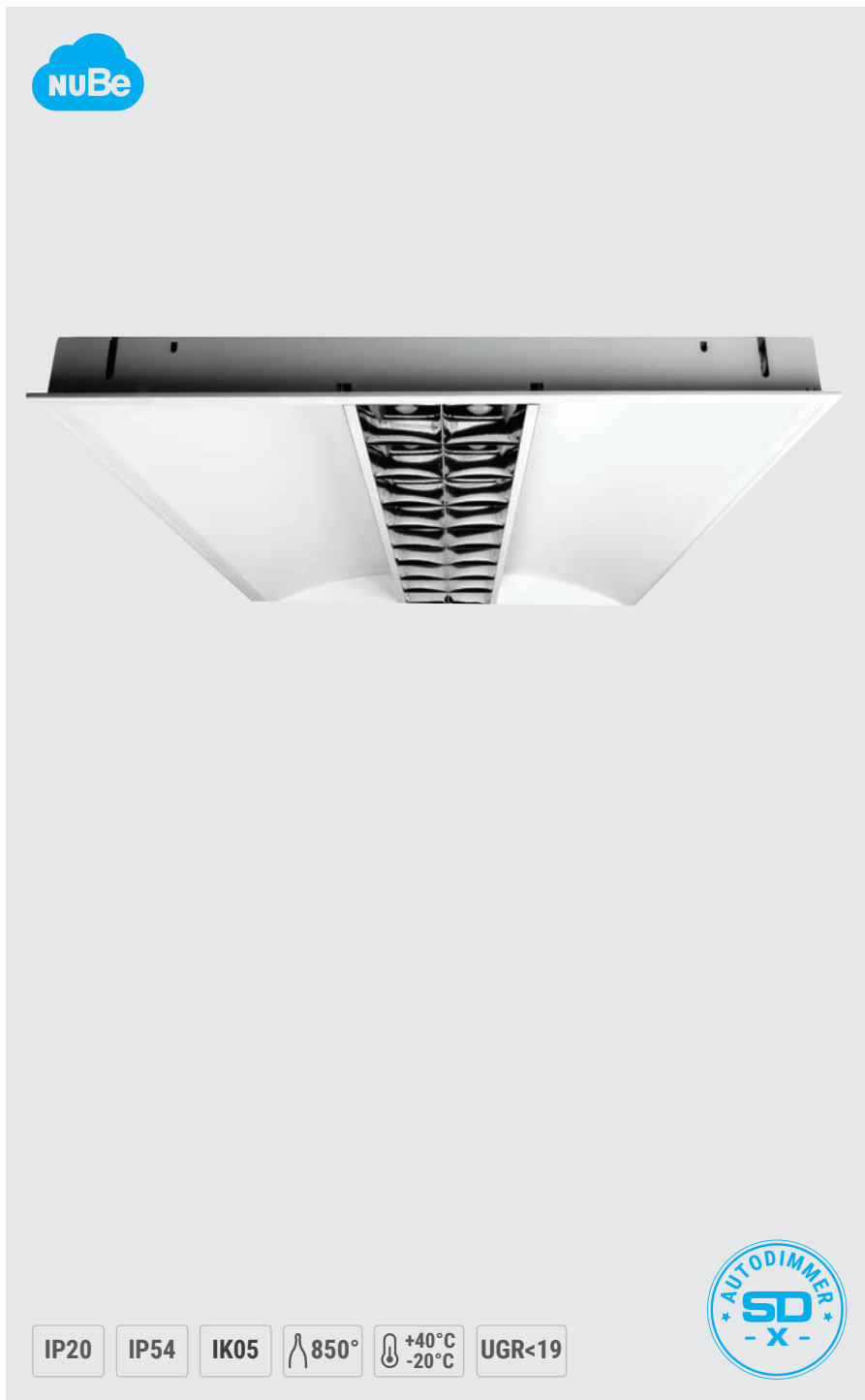

Luminaire with a high visual comfort as well as a high luminous flux of up to 4000lm.



Both recessed and ceiling mounting with ceiling frame adapter, to be ordered separately. IP54 version with additional glass or polycarbonate screen.



The high bay light with direct and indirect light diffuses the lighting in the room with an effective result of soft, but also direct light on the worktop.

Applications

Workplaces with VDTs in both public and private sectors, offices, schools, hospitals

Characteristics

Power supply

SD Universal Multi Voltage 93÷265VAC
50÷60Hz, 176÷250VDC

Power supply - MTBF at 25°C 65,000h

Luminous flux retention at 25°C

>70,000h (L80B20)

Colour stability 3 SDCM

Mounting recessed, slat, plasterboard, ceiling

Housing Polyester powder-coated pre-galvanised sheet metal, RAL 9003

Optics Dark light sheet metal

Compliance EN 60598-1, EN 60598-2-2, EN 60598-2-22, EN 62471 (biological risk-free) 2014/53/EU

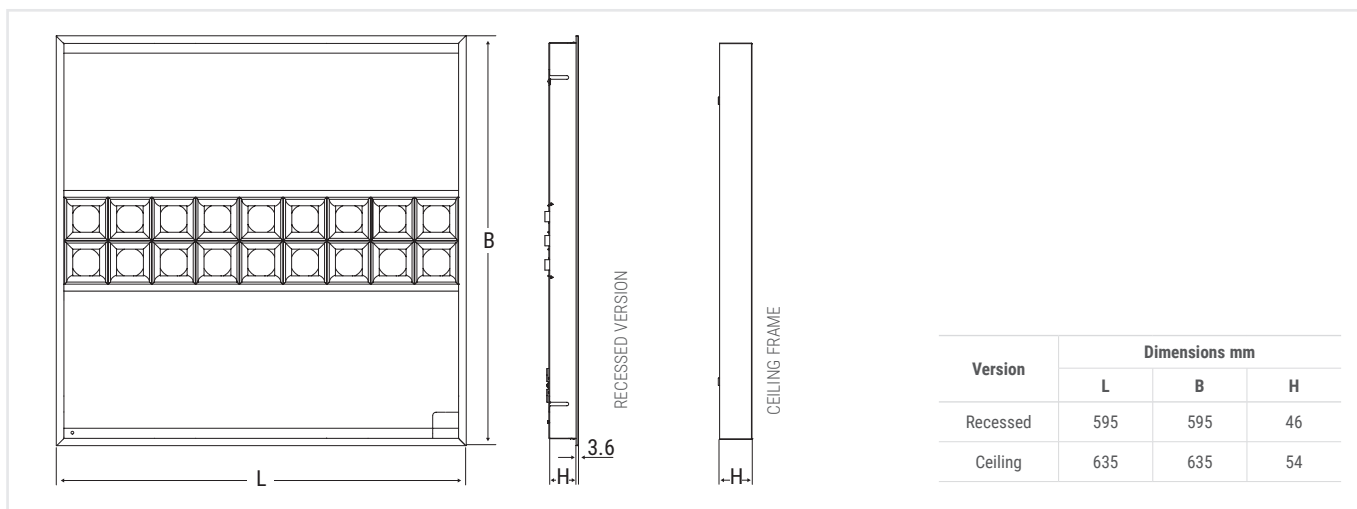

Version	Dimensions mm		
	L	B	H
Recessed	595	595	46
Ceiling	635	635	54

I 418

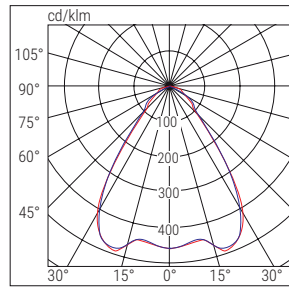

■ C90-C270 ■ C0-C180

I 418 - IP54

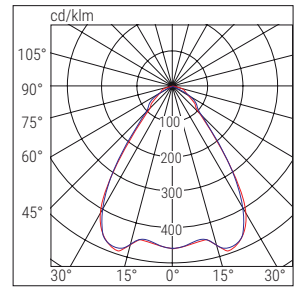

■ C90-C270 ■ C0-C180

	Order Code	Description	Power W	Colour temp. K	Chromatic yield	LED Flux lm (Tj=25°C)	Luminaire flux lm	Brightness efficiency m/W	Weight Kg	Packaging Single/ Multi pack	Notes and compliance
SD	I418SD	INC M600 4X18 LED SD 4K	36	4000	>80	4400	4000	110	3.2	1	AUTO-DIMMER
	I418SDPC	INC M600 4X18 LED SD P IP54 4K	36	4000	>80	4400	3700	100	3.2	1	
	I418SDVT	INC M600 4X18 LED SD V IP54 4K	36	4000	>80	4400	3700	100	3.2	1	

DALI **INTERFACING WITH ACCESSORY TO BE ORDERED SEPARATELY:**
 It is possible to create DALI luminaires by integrating the version **SD** with the accessory **Dali Module** Order Code **15024**
 Example: Order Code **I418SD+ 15024** = Luminaire **I418SD** in the DALI version **DALI**

ACCESSORIES - included



SMART DIMMER LIGHT SENSOR

Order Code **15039**



ACCESSORIES - to be ordered separately

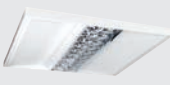

CEILING FRAME

Order Code **1232**

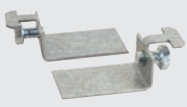

PLASTERBOARD FIXING BRACKETS
4 pieces

Order Code **10404**

BUILDING AUTOMATION - to be ordered separately



LOGICA SD LGFM CONTROL UNIT

Order Code **21102**

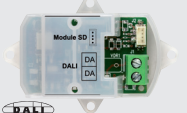

DALI MODULE

Order Code **15024**





BUILDING AUTOMATION RADIO MODULE

Order Code **15022**



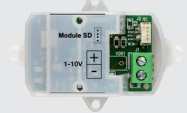

1-10V MODULE

Order Code **15034**





BUILDING AUTOMATION RADIO TRANSMITTER

Order Code **20104**



EMERGENCY LED INVERTERS - to be ordered separately



INVERTER PLUG&LIGHT SE/SA 1-3h 20-60V

Order Code **19358** (1h)
Order Code **19359** (3h)





INVERTER GL AT/LG AR 15W 55V

Order Code **19391** (LiFe battery)
Order Code **19390** (LTO battery)





INVERTER AT/LG AR 9W 55V

Order Code **19355L** (LiFe battery)





LGFM EMERGENCY MODULE
For AT/LG series inverters only

Order Code **19375**



Downlight IP54

nuBe



IP54

IK05

650°



+40°C
-20°C

CRI>90

UGR<19



Downlight with high-efficiency LEDs using SMD technology.



Satin-finish aluminium reflector with a beam aperture angle of 75°, optionally available in white painted or mirror aluminium.

Applications

Services, retail, offices, schools

Characteristics

Power supply

SD 93÷265VAC, 50÷60Hz, 176÷250VDC

ED 230VAC ±10% 50Hz

Power supply - MTBF at 25°C

SD 80,000h ED 70,000h

Luminous flux retention at 25°C

>50,000h (L70B20)

Colour stability 3 SDCM

Mounting recessed, plasterboard

Housing Die-cast aluminium RAL 9016

Optics High-efficiency, satin-finish aluminium (75°)

Compliance EN60598-1, EN60598-2-2, EN 60598-2-22, EN 62471, CAM Minimum Environmental Criteria according to DM 11.01.2017, 2014/53/EU

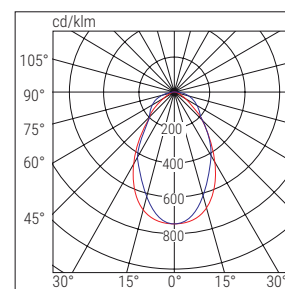

■ C0-C180
■ C90-C270

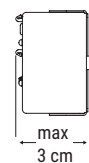
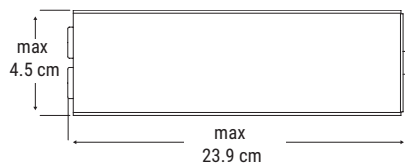
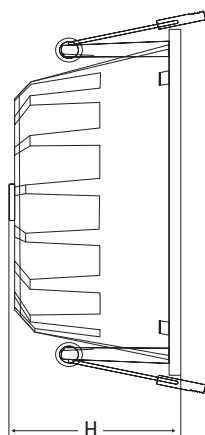
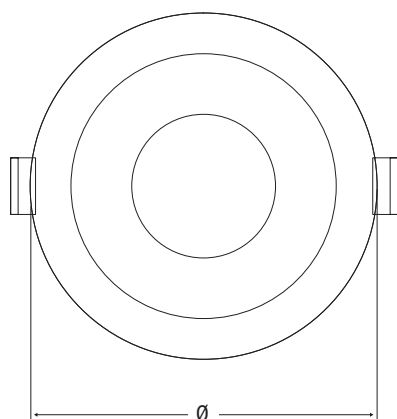



Order code	Recessed mounting hole mm	Dimensions mm	
		Ø	H
40324-40304	Ø90	102	68
40325-40305	Ø120	140	68
40326-40306	Ø150	180	90
40327-40307	Ø200	230	120

	Order Code	Description	Power W	Colour temp. K	Chromatic yield	LED Flux lm (Tj=25°C)	Luminaire flux lm	Brightness efficiency lm/W	Weight Kg	Packaging Single/Multi pack	Notes and compliance	
SD	40324	DWL IP54 10W 75°C90 SAT SD 4K	10	4000	>90	1300	1000	100	0.3	1	75° Optics	AUTO-DIMMER (*)
	40325	DWL IP54 15W 75°C90 SAT SD 4K	15	4000	>90	2000	1500	100	0.5	1	75° Optics	
	40326	DWL IP54 25W 75°C90 SAT SD 4K	25	4000	>90	3300	2500	100	0.7	1	75° Optics	
	40327	DWL IP54 35W 75°C90 SAT SD 4K	35	4000	>90	4600	3500	100	1.2	1/4	75° Optics	
ED	40304	DWL IP54 10W 75°C90 SAT ED 4K	10	4000	>90	1300	1000	100	0.3	1/4	75° Optics	ON / OFF
	40305	DWL IP54 15W 75°C90 SAT ED 4K	15	4000	>90	2000	1500	100	0.5	1/4	75° Optics	
	40306	DWL IP54 25W 75°C90 SAT ED 4K	25	4000	>90	3300	2500	100	0.7	1/4	75° Optics	
	40307	DWL IP54 35W 75°C90 SAT ED 4K	35	4000	>90	4600	3500	100	1.2	1/4	75° Optics	
DALI	INTERFACING WITH ACCESSORY TO BE ORDERED SEPARATELY: It is possible to create DALI luminaires by integrating the version SD with the accessory Dali Module Order Code 15024 Example: Order Code 40324+ 15024 = Luminaire 40324 in the DALI version											DALI

(*) Function that can be activated by integrating the optional external light sensor Code 21100

BUILDING AUTOMATION - to be ordered separately





LOGICA SD LGFM CONTROL UNIT 

Order Code **21102** 



OUTDOOR SMART DIMMER LIGHT SENSOR

Order Code **21100** 



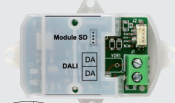

BUILDING AUTOMATION RADIO MODULE

Order Code **15022** 



DALI MODULE

Order Code **15024** 



BUILDING AUTOMATION RADIO TRANSMITTER

Order Code **20104** 



1-10V MODULE

Order Code **15034** 

EMERGENCY LED INVERTERS - to be ordered separately





INVERTER PLUG&LIGHT SE/SA 1-3h 20-60V

Order Code **19358** (1h)
Order Code **19359** (3h) 





LGFM EMERGENCY MODULE
For AT/LG series inverters only

Order Code **19375** 





INVERTER AT/LG AR 9W 55V
Inverter cover (19376) required for installation

Order Code **19355L** (LiFe battery) 



INVERTER COVER IP65

Order Code **19376** 



INVERTER GL AT/LG AR 15W 55V
Inverter cover (19376) required for installation

Order Code **19391** (LiFe battery)
Order Code **19390** (LTO battery) 

Funzione3



- IP20
IP40
- IK05
- 650°
-
- +40°C
-20°C
- CRI>90
- UGR<19



Multi-purpose downlight with a revolutionary design and high luminous flux.



Power supply system adjustable in 4 luminous flux steps to adapt the product to all requirements.



Variable geometry multi-lens screen with 3 different light beams.



Decomposable body for recessed or ceiling mounting without accessories. The ED version has the power supply integrated in the luminaire.

Applications

Services, retail, offices, schools

Characteristics

Power supply

SD 93÷265VAC, 50÷60Hz, 176÷250VDC

ED 230VAC ±10% 50Hz

Power supply - MTBF at 25°C 70,000h

Luminous flux retention at 25°C

>70,000h (L80B20)

Colour stability 3 SDCM

Mounting plasterboard, ceiling, suspended

Housing Polycarbonate, RAL 9003

Optics PMMA Multi-lens

Compliance EN 60598-1, EN 60598-2-2, EN60598-2-22, EN62471 (photobiological risk-free), CAM Minimum Environmental Criteria according to DM 11.01.2017, 2014/53/EU

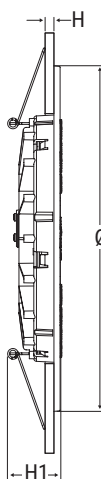
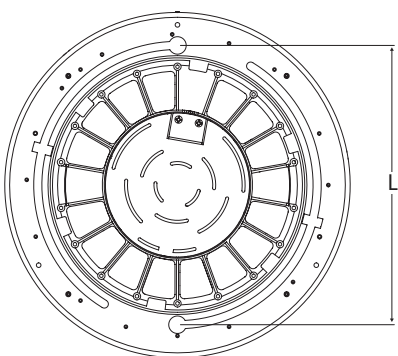

Recessed mounting hole mm	Dimensions mm				
	Ø	H	H1	L	H2
Ø 170÷200	235	6÷25	36	190	32

ONE PRODUCT 27 SOLUTIONS

By combining three types of mounting with the possibility of having three built-in optics on a single product, we offer you nine different combinations with a single device, each featuring 3 different colour temperatures: 3000, 4000, 5000K

WALL WASHER ASYMMETRICAL LENS

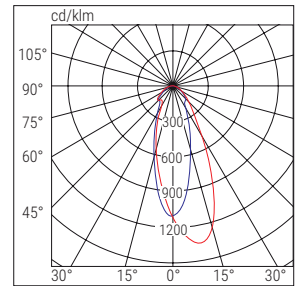

■ C0-C180 ■ C90-C270

CONCENTRATING LENS TYPE DARK LIGHT UGR <19

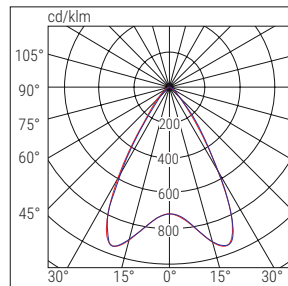

■ C0-C180 ■ C90-C270

DIFFUSING LENS UGR <25

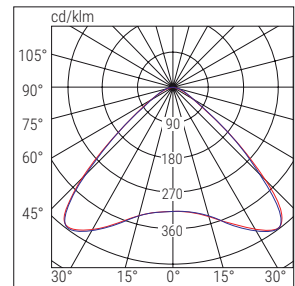

■ C0-C180 ■ C90-C270

MOUNTING



	Order Code	Description	Power W	Colour temp. K	Chromatic yield	LED Flux lm (Tj=25°C)	Luminaire flux lm	Brightness efficiency lm/W	Weight Kg	Packaging Single/ Multi pack	Notes and compliance
SD	226SD4	FUNZIONE3 226 SD 4000K CRI90	13.5	4000	>90	1900	1500	110	0.5	1	AUTO-DIMMER
	170SD3	FUNZIONE3 170 SD 3000K CRI90	24	3000	>90	3400	2700	110	0.5	1	
ED	226ED4	FUNZIONE3 226 ED 4000K CRI90	13.5	4000	>90	1900	1500	110	0.5	1	ON / OFF
	170ED3	FUNZIONE3 170 ED 3000K CRI90	24	3000	>90	3400	2700	110	0.5	1	
	226EDMC	FUNZIONE3 226 ED MULTICOLOUR CRI90	13.5	3000/4000/5000	>90	1900	1500	110	0.5	1	
	170EDMC	FUNZIONE3 170 ED MULTICOLOR CRI90	24	3000/4000/5000	>90	3400	2700	A++	0.5	1	

DALI **INTERFACING WITH ACCESSORY TO BE ORDERED SEPARATELY:**
 It is possible to create DALI luminaires by integrating the version **SD** with the accessory **Dali Module** Order Code **15024**
 Example: Order Code **226SD4+ 15024** = Luminaire **226SD4** in the **DALI** version

NEXT >

Funzione3

lighting

ACCESSORIES - included

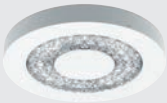

	SMART DIMMER LIGHT SENSOR Order Code 15039	SD
---	---	-----------

ACCESSORIES - to be ordered separately

	CEILING FRAME (included in the ED version) Order Code 20129	
---	---	--

	3-CABLE SUSPENSION Order Code 20128	
--	--	--

BUILDING AUTOMATION - to be ordered separately

	LOGICA SD LGFM CONTROL UNIT Order Code 21102	 SD
---	---	--

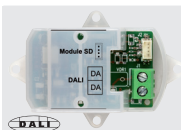
	DALI MODULE Order Code 15024	SD
--	---	-----------

	BUILDING AUTOMATION RADIO MODULE Order Code 15022	SD
---	--	-----------

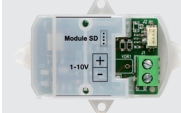
	1-10V MODULE Order Code 15034	SD
--	--	-----------

	BUILDING AUTOMATION RADIO TRANSMITTER Order Code 20104	SD
---	---	-----------

EMERGENCY LED INVERTERS - to be ordered separately (SD version only)

SD

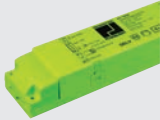
	INVERTER PLUG&LIGHT SE/SA 1-3h 60-180V (SD version only) Order Code 19367 (1h) Order Code 19371 (3h)	TR
---	--	-----------



039 downlight

Rail System Iron

lighting



IP40 IK05 650° +40°C -20°C



Modular system for 8-pole lighting with the possibility of inserting spotlights for three-phase electrified track.



SD version with integrated radio module available. All modules include the LG Emergency Lighting Bus.



Seven lighting modules are available with different beam angles, both symmetrical and asymmetrical.



Complete components for fast and precise installation. The all-steel connection joints are designed with a precision mechanical coupling.

Applications

Medium to large-sized premises for public sales, large-scale retail trade, retail, offices, showrooms

Characteristics

Power supply

230 VAC $\pm 10\%$ 50Hz (Cos $j \geq 0,90$)

Power supply - MTBF at 25°C 80,000h

Luminous flux retention at 25°C

>60,000h (L80B20)

Colour stability 3 SDCM

Mounting ceiling, suspended

Housing Polyester powder-coated pre-galvanised sheet steel, RAL 9010

Optics Clear PMMA lens

Compliance EN 60598-1, EN 60598-2-1, EN 60598-2-22, EN 62471 (biological risk-free) 2014/53/EU

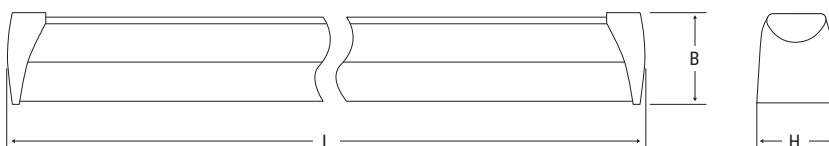

EXAMPLE OF A SINGLE COMPOSITION

- Carrier profile Code 4502
- Double asymmetrical lighting module 50W Code 40520
- 2 x End caps Code 40612

Dimensions mm

L	B	H
1500	73	80

For the dimensions of the individual components in the various versions, please refer to the individual sections below

8-POLE PRE-WIRED MODULAR SYSTEM

The project includes pre-wired modular profiles in a single continuous row and a three-phase electrified track, lighting modules with differentiated light emissions, connections and suspension accessories to create all kinds of routes.

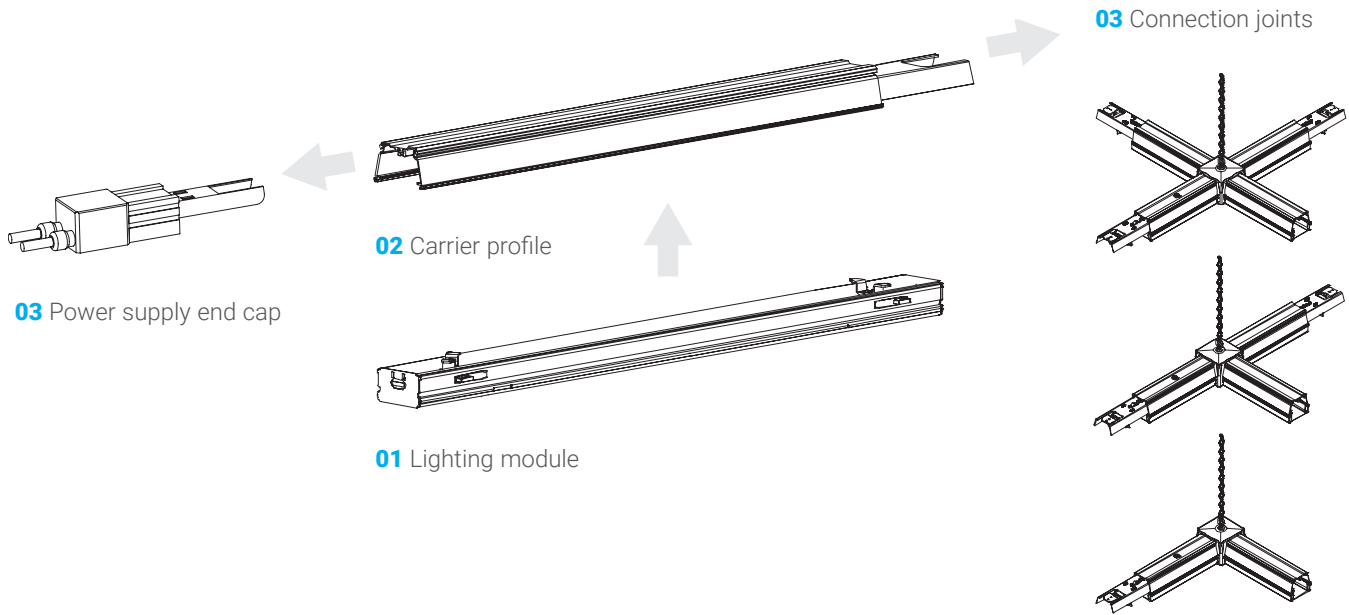

01 LIGHTING MODULE

7 different optics to meet most lighting requirements

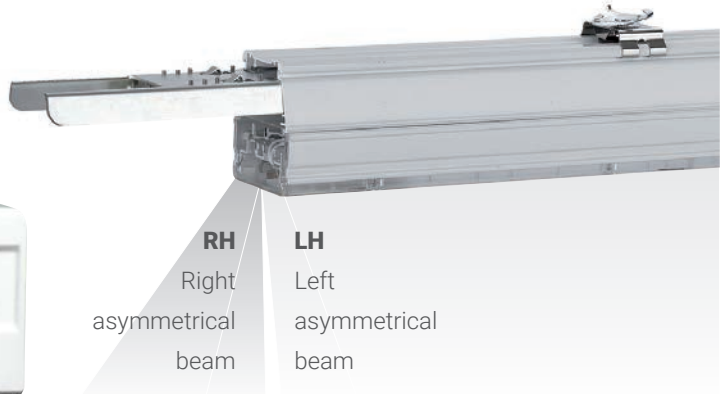

25° - SP

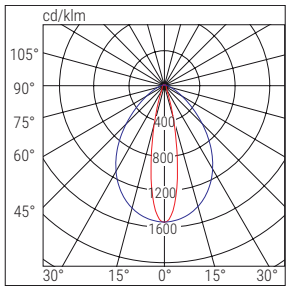

60° - NR

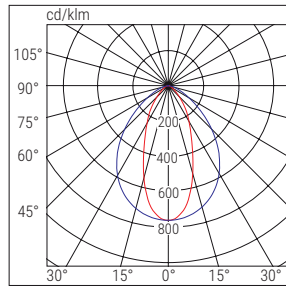

90° - WD

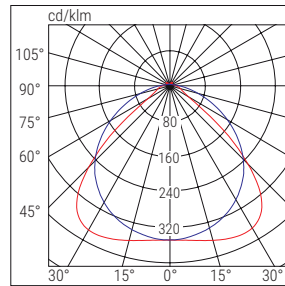

120° - FF

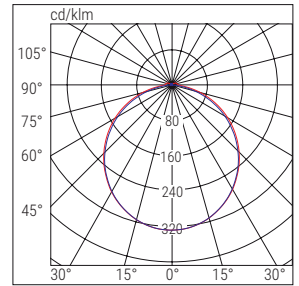

■ C0-C180 ■ C90-C270

ASYMMETRICAL LH - LS

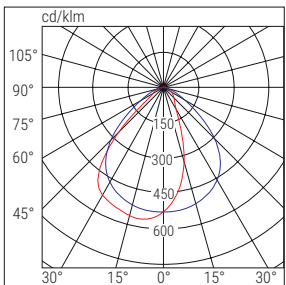

ASYMMETRIC RH - RS

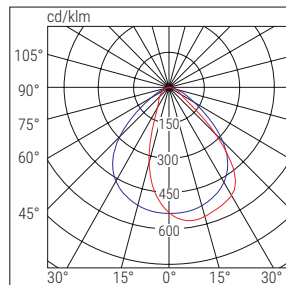

DOUBLE ASYMM - DS

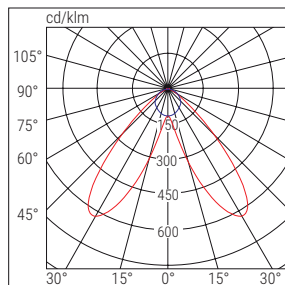

NEXT >

Rail System Iron

lighting

01	Order Code	Description	Optics	Power W	Colour temp. K	Chromatic yield	LED Flux lm (Tj=25°C)	Luminaire flux lm	Brightness efficiency lm/W	Weight Kg	Packaging Single/ Multi pack
SD	40533	RAIL IRON 1500 DS 50W SD 4K	DOUBLE ASYMM.	50	4000	>80	9600	8000	160	1.7	1/10
	40536	RAIL IRON 1500 FF 50W SD 4K	120°	50	4000	>80	9600	8000	160	1.7	1/10
	40530	RAIL IRON 1500 WD 50W SD 4K	90°	35	4000	>80	6700	5600	160	1.7	1/10
	40531	RAIL IRON 1500 SP 50W SD 4K	25°	50	4000	>80	9600	8000	160	1.7	1/10
	40532	RAIL IRON 1500 NR 50W SD 4K	60°	35	4000	>80	6700	5600	160	1.7	1/10
	40534	RAIL IRON 1500 RS 50W SD 4K	ASYMM. RH	50	4000	>80	9600	8000	160	1.7	1/10
	40535	RAIL IRON 1500 LS 50W SD 4K	ASYMM. LH	35	4000	>80	6700	5600	160	1.7	1/10
ED	40513	RAIL IRON 1500 DS 35W ED 4K 0-10V	DOUBLE ASYMM.	35	4000	>80	6700	5600	160	1.7	1/10
	40516	RAIL IRON 1500 FF 35W ED 4K 0-10V	120°	35	4000	>80	6700	5600	160	1.7	1/10
	40520	RAIL IRON 1500 DS 50W ED 4K 0-10V	DOUBLE ASYMM.	50	4000	>80	9600	8000	160	1.7	1/10
	40523	RAIL IRON 1500 FF 50W ED 4K 0-10V	120°	50	4000	>80	9600	8000	160	1.7	1/10
	40510	RAIL IRON 1500 WD 35W ED 4K 0-10V	90°	35	4000	>80	6700	5600	160	1.7	1/10
	40511	RAIL IRON 1500 SP 35W ED 4K 0-10V	25°	35	4000	>80	6700	5600	160	1.7	1/10
	40512	RAIL IRON 1500 NR 35W ED 4K 0-10V	60°	50	4000	>80	9600	8000	160	1.7	1/10
	40514	RAIL IRON 1500 RS 35W ED 4K 0-10V	ASYMM. RH	50	4000	>80	9600	8000	160	1.7	1/10
	40515	RAIL IRON 1500 LS 35W ED 4K 0-10V	ASYMM. LH	35	4000	>80	6700	5600	160	1.7	1/10
	40517	RAIL IRON 1500 WD 50W ED 4K 0-10V	90°	35	4000	>80	6700	5600	160	1.7	1/10
	40518	RAIL IRON 1500 SP 50W ED 4K 0-10V	25°	50	4000	>80	9600	8000	160	1.7	1/10
	40519	RAIL IRON 1500 NR 50W ED 4K 0-10V	60°	50	4000	>80	9600	8000	160	1.7	1/10
	40521	RAIL IRON 1500 RS 50W ED 4K 0-10V	ASYMM. RH	35	4000	>80	6700	5600	160	1.7	1/10
	40522	RAIL IRON 1500 LS 50W ED 4K 0-10V	ASYMM. LH	35	4000	>80	6700	5600	160	1.7	1/10

AUTO-DIMMER (*)

ON / OFF

(*) Function that can be activated by integrating the optional external light sensor Code 21100

02	Type	Order Code	Description	Cable section* mm ²	Dimensions mm			Weight Kg	Packaging Single/ Multi pack
					L	B	H		
CARRIER PROFILES	SIDE-FEED EC TRACK 600mm	40500	RAIL IRON 600 8 WIRE EC	2.5	600	70.2	-	0.7	1/10
	SIDE-FEED EC TRACK 1500mm	40501	RAIL IRON 1500 8 WIRE EC	2.5	1500	70.2	-	1.8	1/10
	SIDE-FEED EC TRACK 3000mm	40504	RAIL IRON 3000 8 WIRE EC	2.5	3000	70.2	-	3.6	1/10
	CENTRAL-FEED CC TRACK 1500mm	40503	RAIL IRON 1500 8 WIRE CC	2.5	1500	70.2	-	1.8	1/10
	CENTRAL-FEED CC TRACK 3000mm	40505	RAIL IRON 3000 8 WIRE CC	2.5	3000	70.2	-	3.6	1/10
	ELECTRIFIED TRACK	40611	SPOT RAIL IRON 1500 7 WIRE		1518	68	21	1.7	1/10

03	Type	Order Code	Description	Weight Kg	Packaging Single/ Multi pack
END CAP AND JOINT CONNECTIONS	40601	RAIL IRON L INL OUTR 8 WIRE			
END CAP AND JOINT CONNECTIONS	40602	RAIL IRON L INR OUTL 8 WIRE S			
END CAP AND JOINT CONNECTIONS	40603	RAIL IRON L POWER 2OUT 8 WIRE			
T-JOINT	40604	RAIL IRON T 1INL 2OUTR 8 WIRE			
T-JOINT	40605	RAIL IRON T 1INR 2OUTL 8 WIRE			
T-JOINT	40606	RAIL IRON T 1INC 2OUTS 8 WIRE			
T-JOINT	40607	RAIL IRON T POWER 3OUT 8 WIRE			
X-JOINT	40608	RAIL IRON X 1 IN 3OUT 8 WIRE			
X-JOINT	40609	RAIL IRON X POWER 4OUT 8 WIRE			

042



Continuous row installation

02 CARRIER PROFILES



PRE-WIRED CARRIER PROFILE

Male-female plug-in system with steel interlocking and through-wiring installed. Available in various lengths: 600, 1500, 3000 mm

The indicated quantities and length values refer to each phase. The electrified track consists of 3 phases, 1 neutral, Ground + 3 wires that can be used to power an emergency lighting system and/or a BUS (Dali or Logica LG)

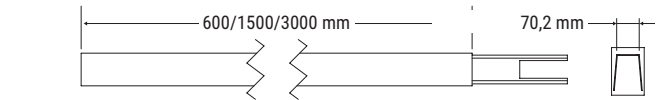

EC track

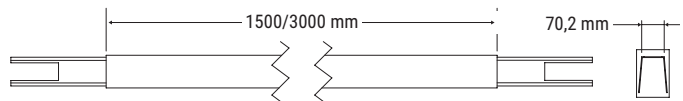

CC track

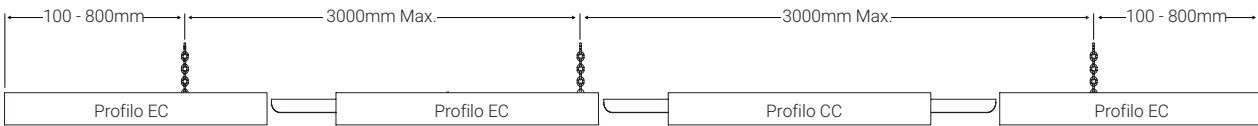

ELECTRIFIED TRACK MODULE

Pre-wired module complete with three-phase electrified track. For this use, UPLED and UPLED BANDIERA is available - a range of emergency luminaires prepared for electrical and mechanical wiring by means of an accessory to be ordered separately (Order Code 4319).

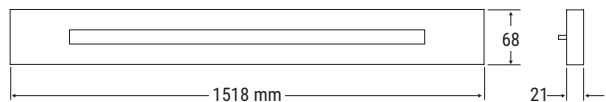

Emergency lighting with Up Led

Rail System Iron

03 END CAP AND CONNECTION JOINTS

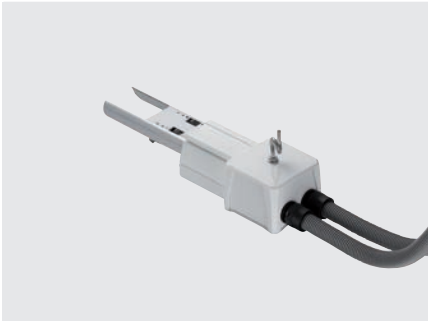

POWER SUPPLY END CAP

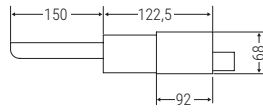

Order Code **40600**



JOINT CONNECTIONS

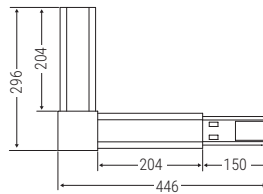

Order Code **40601**

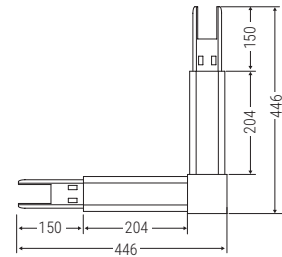

Order Code **40603**

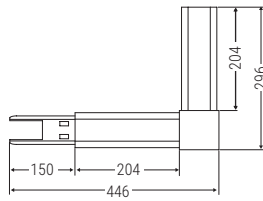

Order Code **40602**



T-JOINT

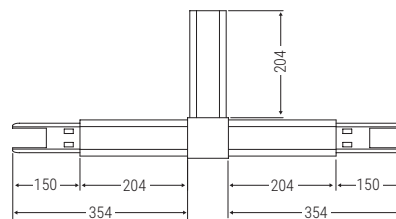

Order Code **40606**

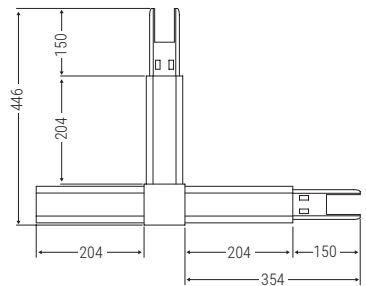

Order Code **40604**

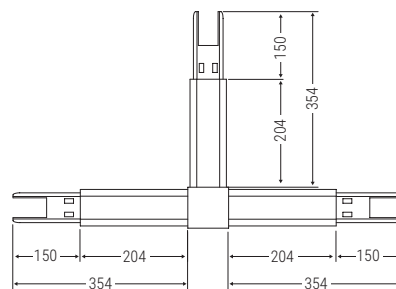

Order Code **40607**

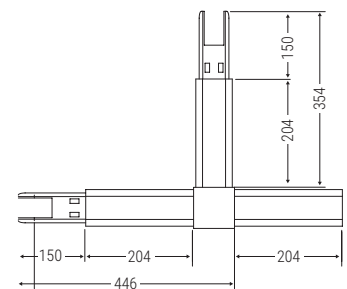

Order Code **40605**



X-JOINT

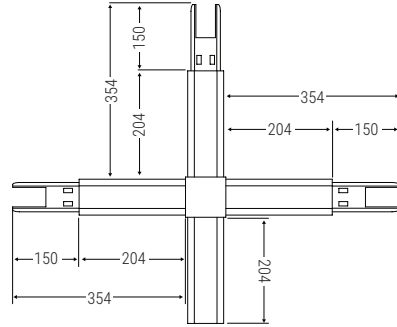

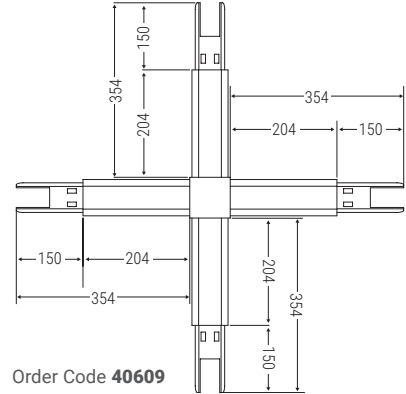

Order Code **40608**





Order Code **40609**

ACCESSORIES - included

	<p>SD RADIO / 1 -10V INTERFACE</p> 
---	--

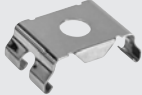
ACCESSORIES - to be ordered separately

	<p>CEILING BRACKET</p> <p>Order Code 40618</p>
--	--

	<p>SLATTED BRACKET</p> <p>Order Code 40617</p>
---	--

	<p>BRACKET WITH 3M STEEL CABLE</p> <p>Order Code 40615</p>
--	--

	<p>BRACKET WITH 3M CABLE</p> <p>Order Code 40616</p>
---	--



	<p>COVER PC 1500</p> <p>Order Code 40614</p>
--	--



	<p>END CAP</p> <p>Order Code 40612</p>
---	--



	<p>THREE-PHASE TRACK END CAP</p> <p>Order Code 40613</p>
--	--

	<p>8-PIN POWER CONNECTOR</p> <p>Order Code 40610</p>
---	--

BUILDING AUTOMATION - to be ordered separately



	<p>LOGICA SD LGFM CONTROL UNIT</p>   <p>Order Code 21102</p>
---	--

	<p>BUILDING AUTOMATION RADIO TRANSMITTER</p>  <p>Order Code 20104</p>
---	--

	<p>OUTDOOR SMART DIMMER LIGHT SENSOR</p>  <p>Order Code 21100</p>
--	--

Lens Fila



-  Continuous row with high luminous flux.
-  Emission-controlled multi-lens system.
-  Feed-through wiring and quick access to the terminal block.

Applications

Services, retail

Characteristics

Power supply

SD 93÷265VAC 50÷60Hz 176÷250VDC

ED 230VAC ±10% 50Hz

Power supply - MTBF at 25°C 80,000h

Luminous flux retention at 25°C

>60,000h (L80B20)

Colour stability 3 SDCM

Mounting ceiling, suspended

Housing Steel painted RAL 9003

Optics Clear PMMA

Compliance EN60598-1, EN60598-2-1, EN 60598-2-22, EN 62471 (biological risk-free) 2014/53/EU

* Single luminaire

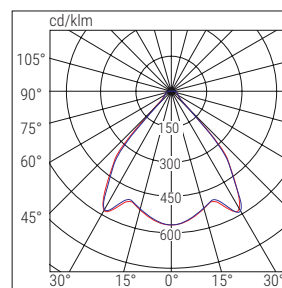

■ C0-C180
■ C90-C270

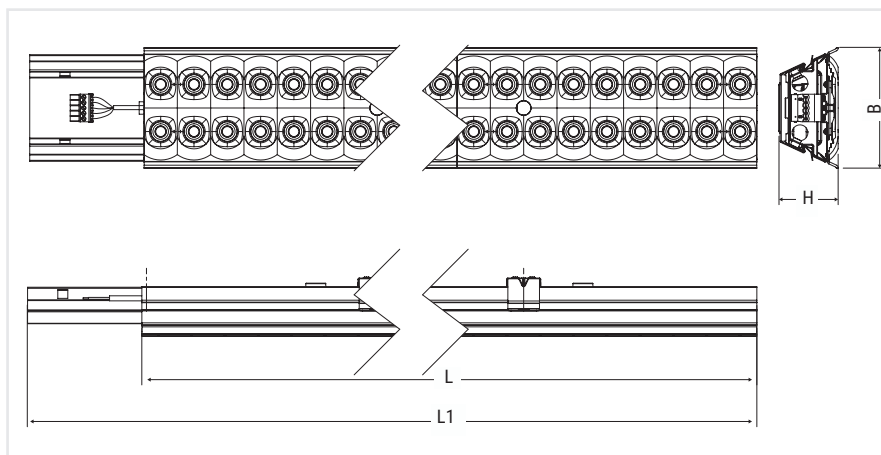

NUMBER OF LAMPS IN CONTINUOUS ROW PER PHASE

Size	No. of lamps 230VAC	Cable cross-section mm ²	Line length m 230VAC
S	-	2.5	-
M	46	2.5	52
L	37	2.5	52

Size	Dimensions mm			
	L	L1	B	H
S	569	719	114	56
M	1138	1288	114	56
L	1422	1572	114	56

	Size	Order Code	Description	Power W	Colour temp. K	Chromatic yield	LED Flux lm (Tj=25°C)	Luminaire flux lm	Brightness efficiency lm/W	Weight Kg	Packaging Single/ Multi pack	Notes and compliance
SD	S	LF218SD*	LENS FILA LED 2x18 SD 4K	30	4000	≥80	4700	4000	133	1.3	1	
	M	LF236SD	LENS FILA LED 2x36 SD 4K	60	4000	≥80	9300	8000	133	2.5	1	
	L	LF280SD	LENS FILA LED 2x80 SD 4K	74	4000	≥80	11600	9900	134	3.5	1	
ED	S	LF218ED*	LENS FILA LED 2x18 ED 4K	27	4000	≥80	4200	3600	134	1.3	1	
	M	LF236ED	LENS FILA LED 2x36 ED 4K	54	4000	≥80	8600	7300	136	1	1	
	L	LF280ED	LENS FILA LED 2x80 ED 4K	67	4000	≥80	10500	9000	135	1	1	
DALI	INTERFACING WITH ACCESSORY TO BE ORDERED SEPARATELY: It is possible to create DALI luminaires by integrating the version SD with the accessory Dali Module Order Code 15024 Example: Order Code LF218SD+ 15024 = Luminaire LF218SD in the DALI version											

* Products can be installed ONLY at the beginning of a row and ALWAYS with code 20138 - NOT with codes 20126 and 20134

ACCESSORIES - included



SMART DIMMER LIGHT SENSOR

Order Code **15039**



BUILDING AUTOMATION - to be ordered separately



LOGICA SD LGFM CONTROL UNIT

Order Code **21102**



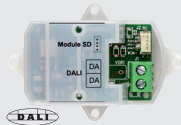

DALI MODULE

Order Code **15024**





BUILDING AUTOMATION RADIO MODULE

Order Code **15022**



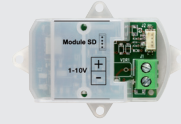

1÷10V MODULE

Order Code **15034**





BUILDING AUTOMATION RADIO TRANSMITTER

Order Code **20104**



ACCESSORIES - to be ordered separately

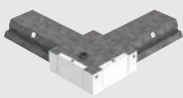

JUNCTION BOX

Order Code **20126**

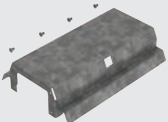

JUNCTION BOX BRACKET

Order Code **20134**



SUSPENDED MOUNTING KIT

Order Code **20127** (1,5m)
Order Code **20133** (3m)

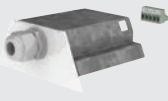

POWER SUPPLY END CAP

Order Code **20138**



5-POLE DUMMY MODULE

Order Code **20135** (600mm)
Order Code **20136** (1200mm)
Order Code **20137** (1500mm)

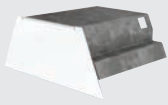

END CAP

Order Code **20139**



5-PIN CONNECTOR F 90° L1 N L2 T L3

Order Code **20141** (male)
Order Code **20140** (female)



5-POLE CONNECTOR F-DP 90° L1 N L2 T L3

Order Code **20142** (female)

NEXT >

Lens Fila

ACCESSORIES - to be ordered separately



CABLE WITH 5-PIN F-CONNECTOR

Order Code **20144** (female)



CABLE WITH 5-PIN M/F CONNECTOR

Order Code **20146** (male-female)



CABLE WITH 5-PIN DOUBLE F CONNECTOR

Order Code **20145** (female)



CABLE WITH 5-PIN CONNECTOR 2X F/F

Order Code **20147** (female-female)

EMERGENCY LED INVERTERS - to be ordered separately



INVERTER PLUG&LIGHT SE/SA 1-3h 20-60V

Order Code **19358** (1h)
Order Code **19359** (3h)

TR



INVERTER GL AT/LG AR 15W 55V

Order Code **19391** (LiFe battery)
Order Code **19390** (LTO battery)

AT LG



INVERTER AT/LG AR 9W 55V

Order Code **19355L** (LiFe battery)

AT LG



LGFM EMERGENCY MODULE
For AT/LG series inverters only

Order Code **19375**

LGFM

COMPONENTS REQUIRED FOR DIFFERENT MOUNTING CONFIGURATIONS

Single luminaire powered from one side

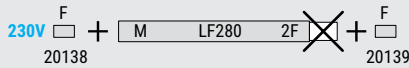

Single luminaire powered from above

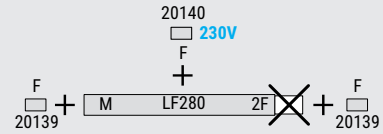

"T" configuration powered from one side

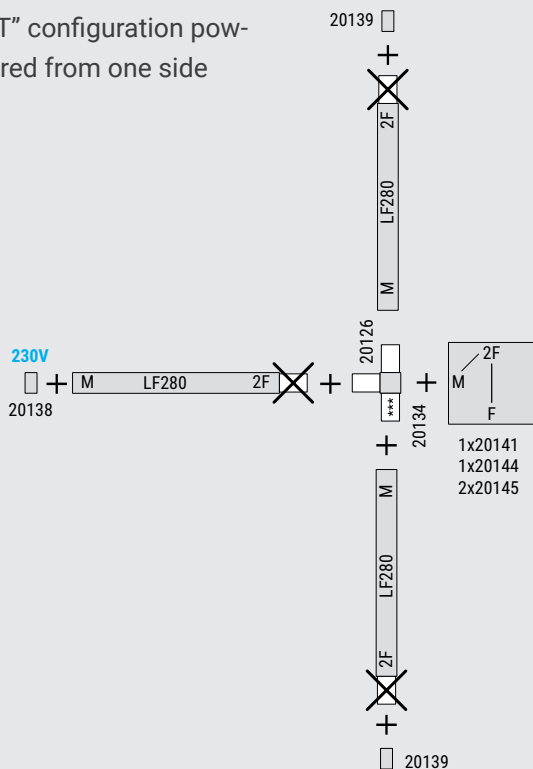

"T" configuration powered by the junction box

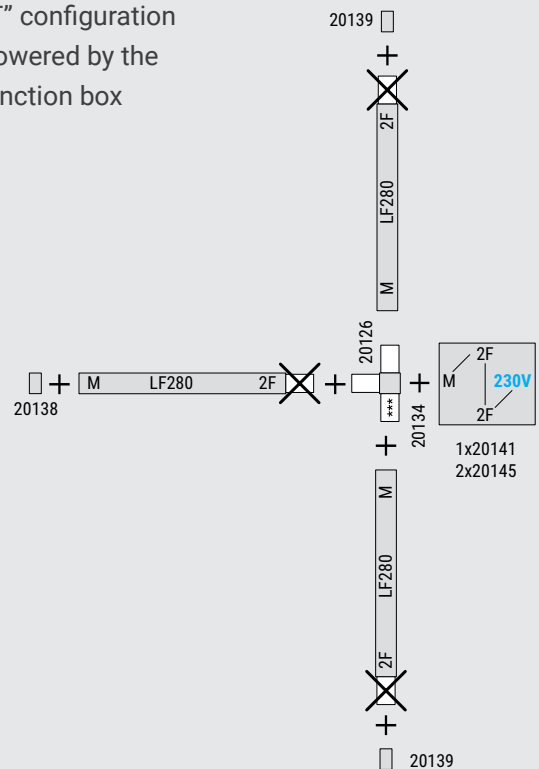

In-line configuration powered from one side

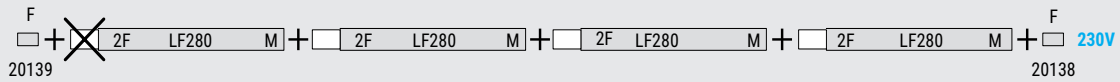

In-line configuration powered from above

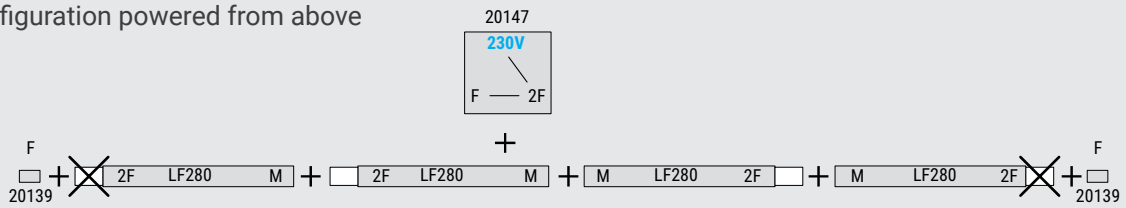

"L" configuration powered from one side

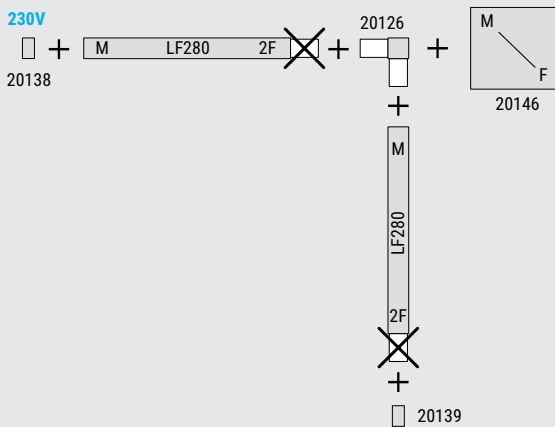

"L" configuration powered by the junction box

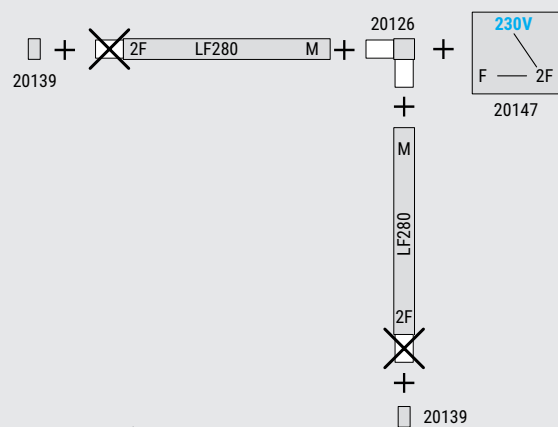

"X" configuration powered from one side

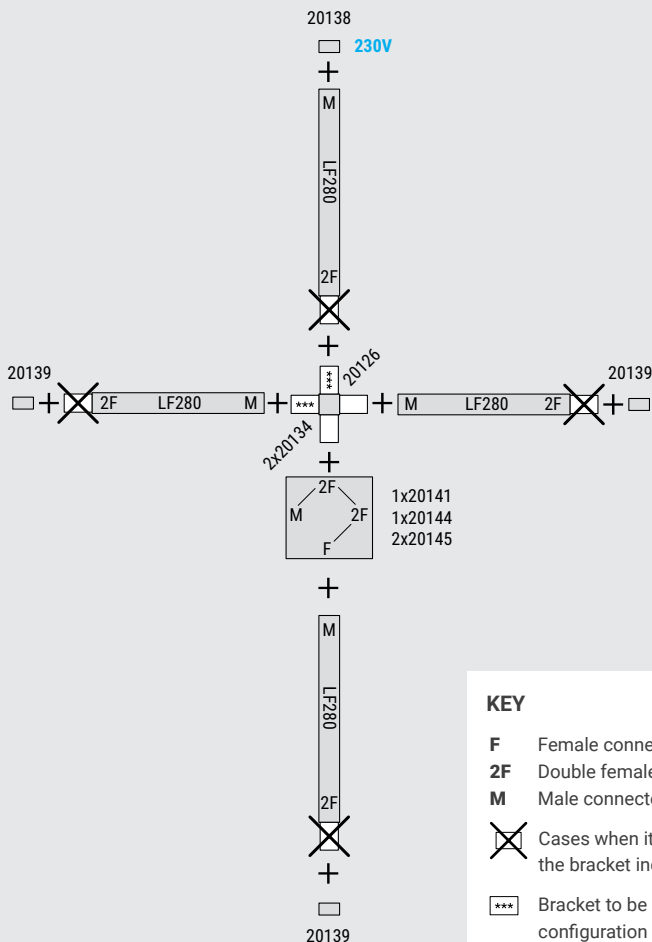

"X" configuration powered by the junction box

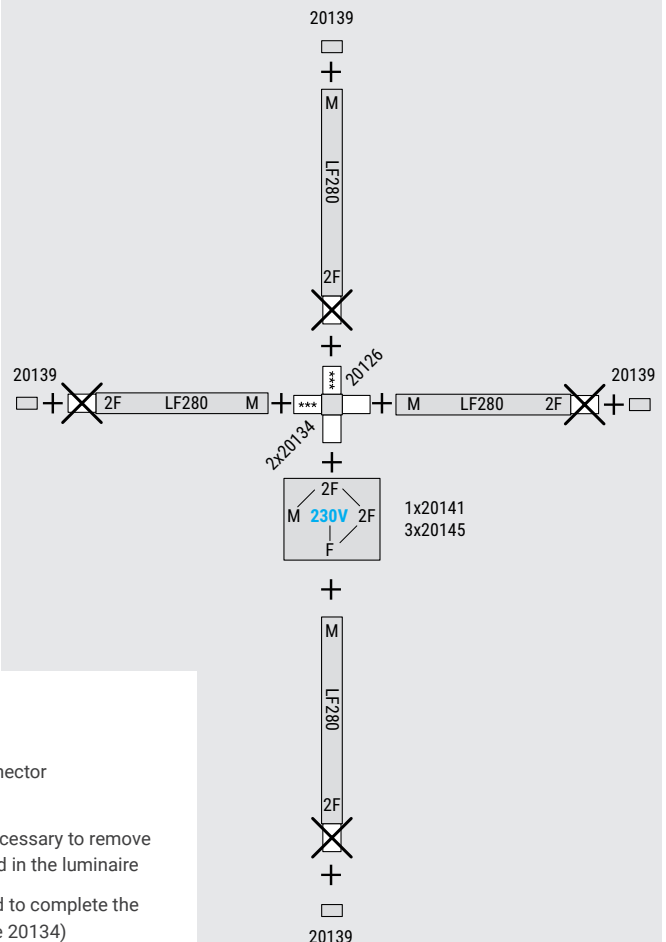

KEY

- F** Female connector
- 2F** Double female connector
- M** Male connector
- Cases when it is necessary to remove the bracket included in the luminaire
- Bracket to be added to complete the configuration (Code 20134)

P236/258

lighting



LED efficiency of up to more than 110 lm/W.



Anti-glare polished aluminium blade optics UGR<19.



Feed-through wiring and accessories for mechanical fastening in continuous rows.

Applications

Services, retail, offices, schools

Characteristics

Power supply

SD Universal Multi Voltage 93÷265VAC
50÷60Hz, 176÷250VDC

Power supply - MTBF at 25°C 65,000h

Luminous flux retention at 25°C

>70,000h (L80B20)

Colour stability 3 SDCM

Mounting ceiling, suspended

Housing Polyester powder-coated pre-galvanised sheet steel, RAL 9003

Optics Dark light blades

Compliance EN 60598-1, EN 60598-2-2, EN 60598-2-22, EN 62471 (biological risk-free) 2014/53/EU

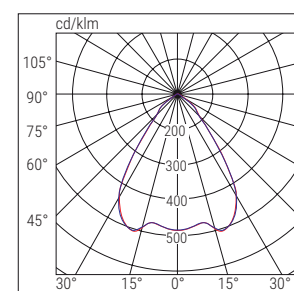

■ C90-C270
■ C0-C180

IP20

IK05

960°

+40°C
-20°C

UGR<19

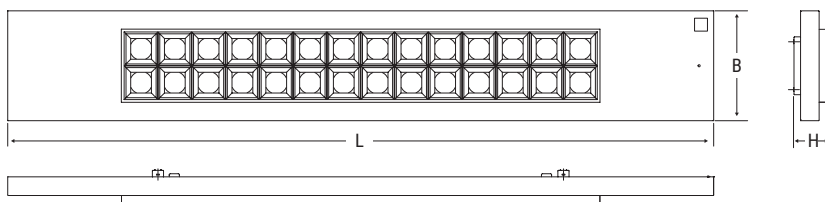

Dimensions mm

L	B	H
1327	202	70

050

	Order Code	Description	Power W	Colour temp. K	Chromatic yield	LED Flux lm (Tj=25°C)	Luminaire flux lm	Brightness efficiency lm/W	Weight Kg	Packaging Single/ Multi pack	Notes and compliance
SD	P236SD	CEILING LED 2x36 SD 4K	36	4000	>80	4800	4000	111	4.6	1	
	P258SD	CEILING LED 2x58 SD 4K	47	4000	>80	6160	5100	109	4.6	1	

AUTO-DIMMER

DALI **INTERFACING WITH ACCESSORY TO BE ORDERED SEPARATELY:**
 It is possible to create DALI luminaires by integrating the version **SD** with the accessory **Dali Module** Order Code **15024**
 Example: Order Code **P236SD+ 15024** = Luminaire **P236SD** in the DALI version

DALI

ACCESSORIES - included



SMART DIMMER LIGHT SENSOR

Order Code **15039**



ACCESSORIES - to be ordered separately



SINGLE SUSPENSION

Order Code **20080**



SUSPENSION+SINGLE MAINS CABLE

Order Code **20081**



CONTINUOUS ROW BRACKET SUSPENSION/BRACKET + CABLE

Order Code **20087**



THREE-PHASE FEED-THROUGH CABLE

Order Code **20088**

BUILDING AUTOMATION - to be ordered separately



LOGICA SD LGFM CONTROL UNIT

Order Code **21102**



DALI MODULE

Order Code **15024**





BUILDING AUTOMATION RADIO MODULE

Order Code **15022**





1÷10V MODULE

Order Code **15034**





BUILDING AUTOMATION RADIO TRANSMITTER

Order Code **20104**



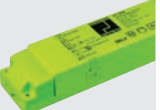

EMERGENCY LED INVERTERS - to be ordered separately



INVERTER PLUG&LIGHT SE/SA 1-3h 20-60V

Order Code **19358** (1h)
 Order Code **19359** (3h)





INVERTER GL AT/LG AR 15W 55V

Order Code **19391** (LiFe battery)
 Order Code **19390** (LTO battery)





INVERTER AT/LG AR 9W 55V

Order Code **19355L** (LiFe battery)





LGFM EMERGENCY MODULE
 For AT/LG series inverters only

Order Code **19375**







BS 100

lighting



IP65 IK05 850° +40°C -20°C



-  Polycarbonate housing with best-in-class mechanical properties, luminous flux up to over 9,600 lm.
-  Power supply system adjustable in 4 luminous flux steps to adapt the product to all requirements.
-  Anti-glare screen for the control of the luminous flux. Specific version for places with particularly low ceilings such as car parks (Parking).
-  Polyurethane sealing gasket with technopolymer snap hooks.

Applications

Industry, garages, gymnasiums, outdoor areas, HACCP areas

Characteristics

- Power supply**
- SD** Universal Multi Voltage 93÷265VAC 50÷60Hz, 176÷250VDC
- ED** 230VAC ± 10% 50/60Hz
- Power supply - MTBF at 25°C** 65,000 h
- Luminous flux retention at 25°C** 60,000 (L80B20)
- Colour stability** 3 SDCM
- Mounting** Ceiling, suspended, electrified track
- Housing** Polycarbonate, RAL 7035
- Optics** Reflective white powder-coated steel
- Compliance** EN 60598-1, EN 60598-2-1, EN 60598-2-22, DIN 18032-3:1997-04, EN 62471 (Photobiological risk-free), 2014/53/EU

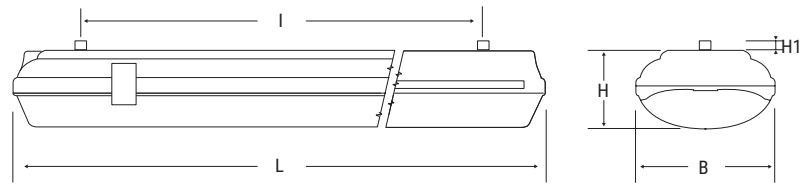

Size	Dimensions mm				
	L	B	H	H1	I
S	671	170	95	10	475
M	1280	170	95	10	660
L	1581	170	95	10	900

BS 100

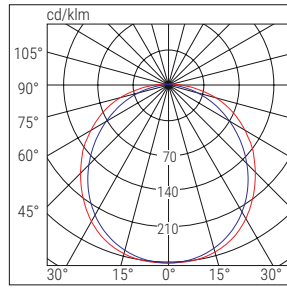

■ C180-C270 ■ C90-C270

BS 100 PARKING

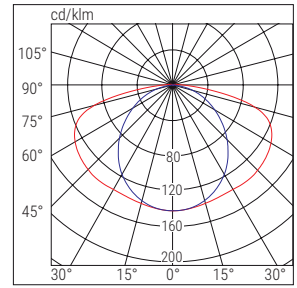

■ C0-C180 ■ C90-C270

	Size	Order Code	Description	Power W	Colour temp. K	Chromatic yield	LED Flux lm (Tj=25°C)	Luminaire flux lm	Brightness efficiency m/W	Weight Kg	Packaging Single/Multi pack	Notes and compliance
SD	S	118SD	BS100 LED 1X18 SD 4K	11	4000	>80	1900	1560	142	1.4	1	
	S	218SD	BS100 LED 2X18 SD 4K	22	4000	>80	3300	3000	136	1.4	1	
	M	136SD	BS100 LED 1X36 SD 4K	23	4000	>80	4000	3300	143	2.3	1	
	M	236SD	BS100 LED 2X36 SD 4K	46	4000	>80	7000	6100	133	2.3	1	
	L	158SD	BS100 LED 1X58 SD 4K	32	4000	>80	5000	4500	141	2.7	1	
	L	258SD	BS100 LED 2X58 SD 4K	64	4000	>80	9250	8350	130	2.7	1	
	L	280SD	BS100 LED 2X80 SD 4K	74	4000	>80	11000	9600	130	2.7	1	
M	236PSD	BS100 LED PARKING 2X36 SD 4K	52	4000	>80	7750	6200	119	2.3	1	Parking	
RD	S	40003	BS100 LED ADJUSTABLE S670 4K	41	4000	>80	6650	5500	134	1.4	1	
	M	40004	BS100 LED ADJUSTABLE M1280 4K	53	4000	>80	8100	7000	132	2.3	1	
	L	40005	BS100 LED ADJUSTABLE L1580 4K	59	4000	>80	9150	8000	136	2.7	1	
DALI	INTERFACING WITH ACCESSORY TO BE ORDERED SEPARATELY: It is possible to create DALI luminaires by integrating the version SD with the accessory Dali Module Order Code 15024 Example: Order Code 118SD + 15024 = Luminaire 118SD in the DALI version											

RD VERSIONS, MANUALLY ADJUSTABLE FLUX/POWER AT 4 STEPS

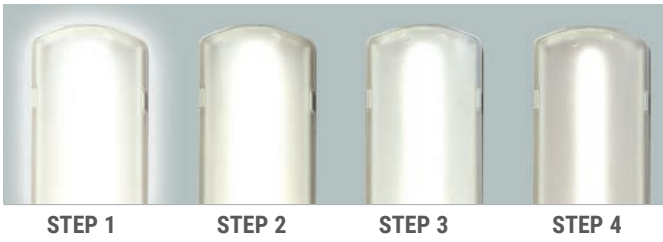

Flux/Power	S			M			L		
	lm	W	lm/W	lm	W	lm/W	lm	W	lm/W
STEP 1	5500	41	134	7000	53	132	8000	59	136
STEP 2	5000	36	139	6500	47	138	7500	53	142
STEP 3	4500	32	141	6000	44	136	7000	50	140
STEP 4	3500	25	140	5500	39	141	6500	45	144

The lighting system must consider both the required level of lighting obtained from the lighting calculation and the power saving needs. BS100 LED Adjustable allows you to achieve this result thanks to its driver equipped with a 4-step current modulation switch that provides maximum luminous efficiency and, therefore, maximum power saving, while respecting the luminous flux determined in the design phase.

BS 100

lighting

SPECIAL VARIANTS - on request

COLOUR TEMPERATURE 3000K and 6000K - CHROMATIC YIELD >90 - MICROWAVE MOTION SENSOR

ACCESSORIES - included



CABLE GLAND M20



SMART DIMMER LIGHT SENSOR

Order Code **15039**



ACCESSORIES - to be ordered separately

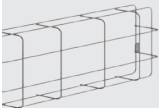

PROTECTIVE GRILLE

Order Code **3905** Vers. S - 685 x 182 x 110 mm
Order Code **8063** Vers. M/L - 1700 x 291 x 135 mm

Installation note
When installing grilles with the luminaire installed on a bus bar, use: Bracket **8063/1** for the M version - Bracket **8063/2** for the L version



STEEL HOOK KIT

Order Code **3505** Vers. S - 4 pieces
Order Code **3506** Vers. M - 8 pieces
Order Code **3507** Vers. L - 10 pieces



WALL-MOUNTED BRACKETS



Order Code **3504**

BUILDING AUTOMATION - to be ordered separately



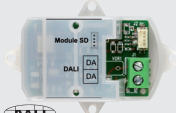

LOGICA SD LGFM CONTROL UNIT

Order Code **21102**

DALI MODULE

Order Code **15024**



BUILDING AUTOMATION RADIO MODULE

Order Code **15022**





1-10V MODULE

Order Code **15034**





BUILDING AUTOMATION RADIO TRANSMITTER

Order Code **20104**



EMERGENCY LED INVERTERS - to be ordered separately



INVERTER PLUG&LIGHT SE/SA 1-3h 20-60V

Order Code **19358** (1h)
Order Code **19359** (3h)





INVERTER GL AT/LG AR 15W 55V

Order Code **19391** (LiFe battery)
Order Code **19390** (LTO battery)

INVERTER AT/LG AR 9W 55V

Order Code **19355L** (LiFe battery)

LGFM EMERGENCY MODULE
For AT/LG series inverters only

Order Code **19375**



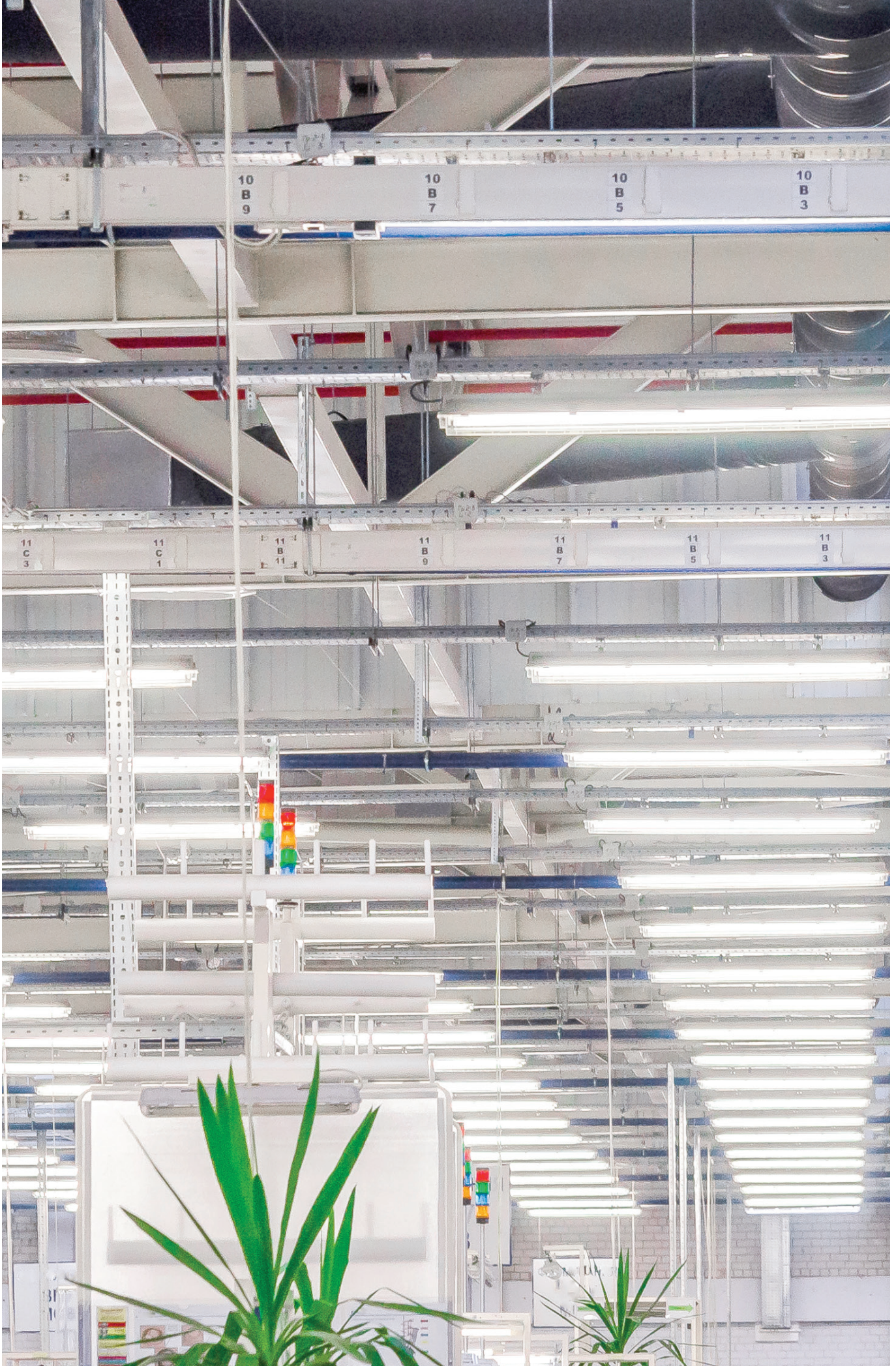

055 waterproof ceiling lights

Acciaio

lighting



IP66 **IK09** **950°** **SD DERATING** **RD**



- High robustness for applications in high-risk areas
- Independent cell optical design to increase beam control and maximise illuminance levels up to 20% higher than conventional optics

Applications

Industry - for heavy-duty and high-risk installations, outdoor environments

Characteristics

- Power supply**
- SD** Universal Multi Voltage
93÷265 VAC - 50/60Hz 176÷250 VDC
- RD** 230VAC ±10% 50 Hz
- Power supply - MTBF a 25°C** 80,000 h
- Luminous flux retention at 25°C**
- >60,000h (2x versions) (L80B20)
- >70,000h (1x versions) (L80B20)
- Colour stability** 3 SDCM
- Mounting** Ceiling, suspended, electrified track
- Housing** Painted steel, RAL7035
- Optics** Anti-glare aluminium cells
- Screen** Tempered glass prism
- Compliance** EN 60598-1, EN 60598-2-1, EN 60598-2-22, DIN 18031-3, EN 62471 (photobiological risk-free), ATEX 2014/34/EU, 2014/53/EU

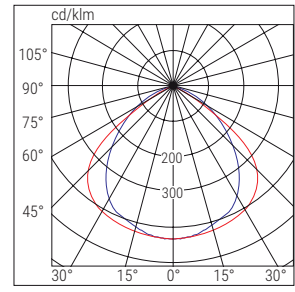

■ C0-C180
■ C09-C270

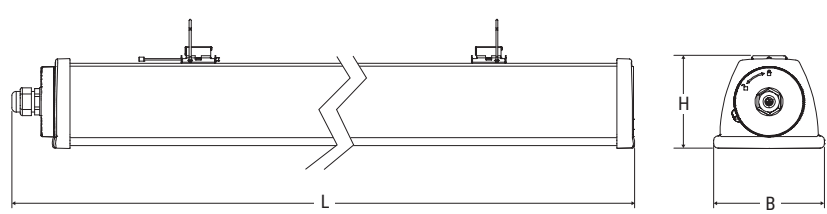

Size	Dimensions mm		
	L	B	H
M	1225	108	90
L	1565	108	90

	Size	Order Code	Description	Power W	Colour temp. K	Chromatic yield	LED Flux lm (Tj=25°C)	Luminaire flux lm	Brightness efficiency lm/W	Weight Kg	Packaging Single/Multi pack	Notes and compliance
SD	M	A136ESD	STEEL AND LED 1X36 SD 4K	20	4000	>80	3150	2700	135	3.2	1	
	M	A236ESD	STEEL AND LED 2X36 SD 4K	35	4000	>80	5570	4700	135	3.2	1	
	M	A158ESD	STEEL AND LED 1X58 SD 4K	29	4000	>80	4400	3800	131	3.2	1	
	M	A258ESD	STEEL AND LED 2X58 SD 4K	52	4000	>80	8350	7000	135	3.2	1	
	L	A280ESD	STEEL TOP LED 2X80 SD 4K	74	4000	>80	11800	9900	135	3.9	1	
RD	M	A236ED	STEEL LED ADJUSTABLE 2x36 4K	36	4000	>80	5400	4400	122	3.2	1	
	M	A258ED	STEEL LED ADJUSTABLE 2x58 4K	52	4000	>80	8050	6400	123	3.2	1	
DALI	INTERFACING WITH ACCESSORY TO BE ORDERED SEPARATELY: It is possible to create DALI luminaires by integrating the version SD with the accessory Dali Module Order Code 15024 Example: Order Code A136ESD + 15024 = Luminaire A136ESD in the DALI version											

RD VERSIONS, MANUALLY ADJUSTABLE FLUX/POWER AT 4 STEPS



Flux/Power	Order A236ED			Order A258ED		
	lm	W	lm/W	lm	W	lm/W
STEP 1	4400	36	122	6400	52	123
STEP 2	3800	31	122	5500	45	122
STEP 3	3200	26	123	4600	37	124
STEP 4	2600	21	124	3700	30	123

The lighting system must consider both the required level of lighting obtained from the lighting calculation and the power saving needs. Steel Adjustable allows you to achieve this result thanks to its driver equipped with a 4-step current modulation switch that provides maximum luminous efficiency and, therefore, maximum power saving, while respecting the luminous flux determined in the design phase.

SPECIAL VARIANTS - on request

CHROMATIC YIELD ≥ 90 - COLOUR TEMPERATURE - THREE-PHASE ELECTRIFIED FEED-THROUGH - POLYCARBONATE DIFFUSER (HACCP)

ACCESSORIES - included



SMART DIMMER LIGHT SENSOR

Order Code **15040**



ACCESSORIES - to be ordered separately



DIFFUSING SCREEN 1200 - 1500

Order Code **20107** (1200) - **20113** (1500)



SWIVEL BRACKET
2 pieces

Order Code **20122**



DOUBLE INLET FITTING M20

Order Code **15019**



ATEX STEEL KIT
(Included in the 2x80 version)

Order Code **15018**

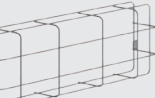

PROTECTIVE GRILLE

Order Code **8063** Vers. M/L - 1700 x 291 x 135 mm

Installation note
When installing grilles with the luminaire installed on a bus bar, use: Bracket **8063/1** for the M version - Bracket **8063/2** for the L version

NEXT >

Acciaio









lighting

BUILDING AUTOMATION - to be ordered separately

	<p>LOGICA SD LGFM CONTROL UNIT </p> <p>Order Code 21102 </p>	 <p>DALI MODULE</p> <p>Order Code 15024 </p>
	<p>BUILDING AUTOMATION RADIO TRANSMITTER</p> <p>Order Code 20104 </p>	 <p>1÷10V MODULE</p> <p>Order Code 15034 </p>
	<p>BUILDING AUTOMATION RADIO MODULE</p> <p>Order Code 15022 </p>	



EMERGENCY LED INVERTERS - to be ordered separately (SD version only)



 <p>INVERTER PLUG&LIGHT SE/SA 1-3h 20-60V</p> <p>Order Code 19358 (1h) Order Code 19359 (3h) </p>	 <p>INVERTER GL AT/LG AR 15W 55V</p> <p>Order Code 19391 (LiFe battery)  Order Code 19390 (LTO battery)</p>
 <p>INVERTER AT/LG AR 9W 55V</p> <p>Order Code 19355L (LiFe battery) </p>	 <p>LGFM EMERGENCY MODULE For AT/LG series inverters only</p> <p>Order Code 19375 </p>

EMERGENCY LED INVERTERS - to be ordered separately (RD version only)



 <p>INVERTER PLUG&LIGHT SE/SA 1-3h 60-180V</p> <p>Order Code 19367 (1h) Order Code 19371 (3h) </p>



059 waterproof ceiling lights

Acciaio Extreme

lighting



IP66
IK09
950°
DERATING +50°C -30°C
Ex



Maximum mechanical and chemical resistance. Luminaire designed to withstand vibration and magnetic disturbance



Anti-glare system with aluminium cells and micro-prismatic glass screen

Applications

Industry, also outdoor, for particularly heavy and high-risk systems, also resistant to mechanical vibrations and electromagnetic disturbances

Characteristics

- Power supply** Universal Multi Voltage 93÷265 VAC - 50/60Hz 176÷250 VDC
- Power supply - MTBF a 25°C** 80,000 h
- Luminous flux retention at 25°C** >60,000h (L80B20)
- Colour stability** 3 SDCM
- Mounting** Ceiling, suspended, electrified track
- Housing** Stainless Steel AISI 304
- Optics** Anti-glare aluminium cells
- Screen** Tempered glass prism
- Compliance** EN 60598-1, EN 60598-2-1, EN 60598-2-22, DIN 18031-3, EN 62471 (photobiological risk-free), ATEX 2014/34/EU (Zone 02 and 22), 2014/53/EU

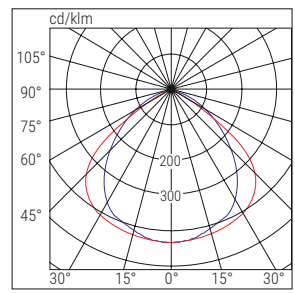

■ C0-C180
■ C90-C270

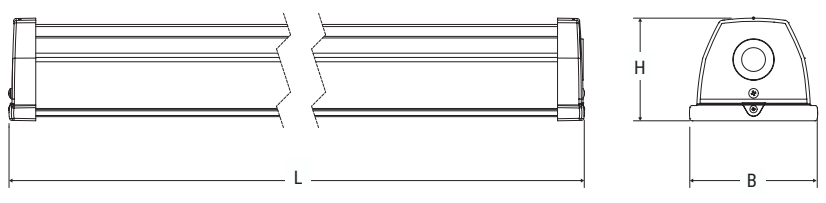

Size	Dimensions mm		
	L	B	H
M	1199	109	88
L	1484	109	88

060

	Size	Order Code	Description	Power W	Colour temp. K	Chromatic yield	LED Flux lm (Tj=25°C)	Luminaire flux lm	Brightness efficiency lm/W	Weight Kg	Packaging Single/Multi pack	Notes and compliance
SD	M	A236EXSD	STEEL EX LED 2x36 SD 4K	35	4000	≥80	5500	4700	135	3.3	1	Ex
	M	A258EXSD	STEEL EX LED 2x58 SD 4K	52	4000	≥80	8200	7000	135	3.3	1	Ex
	L	A280EXSD	STEEL EX LED 2x80 SD 4K	74	4000	≥80	11600	9900	135	4	1	Ex

AUTO-DIMMER

DALI **INTERFACING WITH ACCESSORY TO BE ORDERED SEPARATELY:**
 It is possible to create DALI luminaires by integrating the version **SD** with the accessory **Dali Module** Order Code **15024**
 Example: Order Code **A236EXSD + 15024** = Luminaire **A236EXSD** in the DALI version

DALI

SPECIAL VARIANTS - on request

CHROMATIC YIELD ≥90 - COLOUR TEMPERATURE ON REQUEST - VERSION WITH POLYCARBONATE DIFFUSER FOR HACCP ENVIRONMENTS

ACCESSORIES - included



SMART DIMMER LIGHT SENSOR

Order Code **15040**



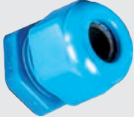

ATEX CABLE GLAND - FEED-THROUGH KIT

ACCESSORIES - to be ordered separately

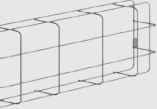

PROTECTIVE GRILLE

Order Code **8063** Vers. M/L - 1700 x 291 x 135 mm

Installation note

To mount grilles with the luminaire installed on a bus bar, use: Bracket **8063/1** for the M version - Bracket **8063/2** for the L version



DOUBLE INLET FITTING M20

Order Code **15019**

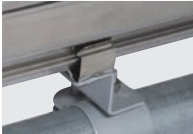

POLE BRACKET

Order Code **20125**



SWIVEL BRACKET

Order Code **20123**

BUILDING AUTOMATION - to be ordered separately



LOGICA SD LGFM CONTROL UNIT

Order Code **21102**



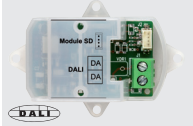



DALI MODULE

Order Code **15024**





BUILDING AUTOMATION RADIO MODULE

Order Code **15022**



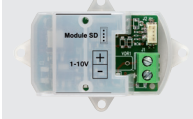

1÷10V MODULE

Order Code **15034**





BUILDING AUTOMATION RADIO TRANSMITTER

Order Code **20104**



EMERGENCY LED INVERTERS - to be ordered separately

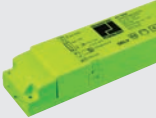

INVERTER PLUG&LIGHT SE/SA 1-3h 20-60V

Order Code **19358** (1h)
Order Code **19359** (3h)





INVERTER GL AT/LG AR 15W 55V

Order Code **19391** (LiFe battery)
Order Code **19390** (LTO battery)





INVERTER AT/LG AR 9W 55V

Order Code **19355L** (LiFe battery)





LGFM EMERGENCY MODULE

For AT/LG series inverters only

Order Code **19375**



BS240

lighting



IP66

IK18

850°

DERATING

+50°C
-20°C



Great robustness of a luminaire with a luminous flux of up to more than 21,000lm. Extremely compact dimensions.



Large symmetrical beam angle on 4 sides, especially for locations with particularly low ceilings (Parking version)

Applications

Industry, services, gyms, car parks, warehouses, shopping centres, areas subject to HACCP

Characteristics

Power supply Universal Multi Voltage
93÷265 VAC - 50/60Hz 176÷250 VDC

Power supply - MTBF a 25°C 80,000 h

Luminous flux retention at 25°C
>70,000h (L80B20)

Colour stability 3 SDCM

Mounting Ceiling, suspended, electrified track

Housing Polyester powder-coated die-cast aluminium, RAL 7040

Optics Anti-glare aluminium, diffusing

Compliance EN 60598-1, EN 60598-2-1, EN 60598-2-22, DIN 18031-3, EN 62471 (photobiological risk-free), 2014/53/EU

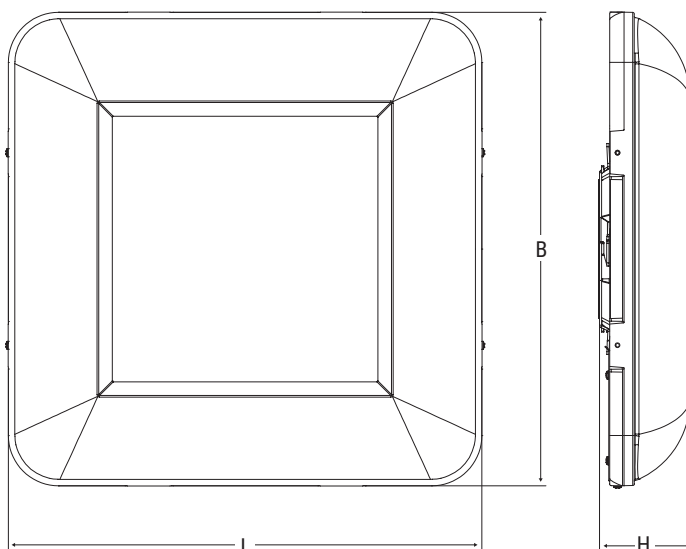

Dimensions mm

L	B	H
443	443	85

062

BS240

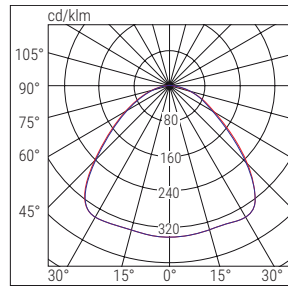

■ C0-C180 ■ C90-C270

BS240 PARKING

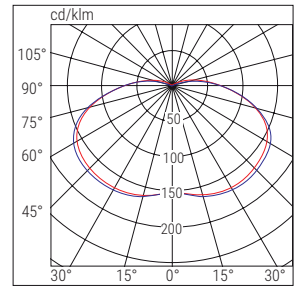

■ C0-C180 ■ C90-C270

	Order Code	Description	Power W	Colour temp. K	Chromatic yield	LED Flux lm (Tj=25°C)	Luminaire flux lm	Brightness efficiency lm/W	Weight Kg	Packaging Single/ Multi pack	Notes and compliance	
SD	11288SD	BS240 LED 455 SD 4K	100	4000	≥80	15500	13300	133	5.5	1		AUTO-DIMMER
	11289SD	BS240 LED 655 SD 4K	160	4000	≥80	23300	21300	133	5.5	1		
	11288PSD	BS240 LED 255 SD 4K	50	4000	≥80	7800	6650	133	5	1	Parking	
ED	11288ED	BS240 LED 455 ED 4K	100	4000	≥80	15500	13300	133	5.5	1		ON / OFF
	11289ED	BS240 LED 655 ED 4K	160	4000	≥80	23300	21300	133	5.5	1		
	11288PED	BS240 LED PARK ED 4K	50	4000	≥80	7800	6650	133	5	1	Parking	
DALI	INTERFACING WITH ACCESSORY TO BE ORDERED SEPARATELY: It is possible to create DALI luminaires by integrating the version SD with the accessory Dali Module Order Code 15024 Example: Order Code 11288SD + 15024 = Luminaire 11288SD in the DALI version											DALI

ACCESSORIES - included



SMART DIMMER LIGHT SENSOR

Order Code **15039**





CEILING MOUNTING BRACKET



CONDUIT FIXING BRACKET

Order Code **12665**



EYE-BOLTS FOR SUSPENDED MOUNTING

ACCESSORIES - to be ordered separately



SUSPENDED MOUNTING KIT

Order Code **12663**









BS240

lighting

BUILDING AUTOMATION - to be ordered separately

	<p>LOGICA SD LGFM CONTROL UNIT </p> <p>Order Code 21102 </p>	 <p>DALI MODULE</p> <p>Order Code 15024 </p>
	<p>BUILDING AUTOMATION RADIO TRANSMITTER</p> <p>Order Code 20104 </p>	 <p>1÷10V MODULE</p> <p>Order Code 15034 </p>
	<p>BUILDING AUTOMATION RADIO MODULE</p> <p>Order Code 15022 </p>	

EMERGENCY LED INVERTERS - to be ordered separately

	<p>INVERTER PLUG&LIGHT SE/SA 1-3h 20-60V</p> <p>Order Code 19358 (1h) Order Code 19359 (3h) </p>	 <p>INVERTER GL AT/LG AR 15W 55V</p> <p>Order Code 19391 (LiFe battery)  Order Code 19390 (LTO battery)</p>
	<p>INVERTER AT/LG AR 9W 55V</p> <p>Order Code 19355L (LiFe battery) </p>	 <p>LGFM EMERGENCY MODULE For AT/LG series inverters only</p> <p>Order Code 19375 </p>



065 waterproof ceiling lights

Flood Mini

lighting



IP66

IK09

960°

+40°C
-20°C



Maximum mechanical and chemical resistance. Luminaire designed to withstand the most extreme outdoor conditions.



Removable aluminium cell high bay light for a single symmetrical or asymmetrical luminaire.

Applications

Industry, services, residential

Characteristics

Power supply 230VAC ±10% 50 Hz

Power supply - MTBF at 25°C 65,000 h

Luminous flux retention at 25°C

>50,000h (F70) (L80B20)

>60,000h (F30-F50) (L80B20)

Colour stability 3 SDCM

Mounting Floor, wall

Housing Polyester powder-coated die-cast aluminium, RAL 7040

Optics Parabolic blades, made of anti-iridescent polished anodised aluminium. Symmetrical, Asymmetrical

Screen Tempered glass prism, 4mm thick

Compliance EN 60598-1, EN 60598-2-22, EN 62471 (photobiological risk-free), EN 60598-2-2, 2014/30/EU, 2014/35/EU

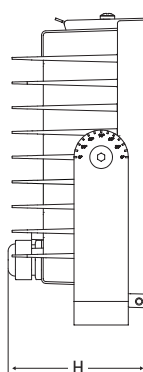
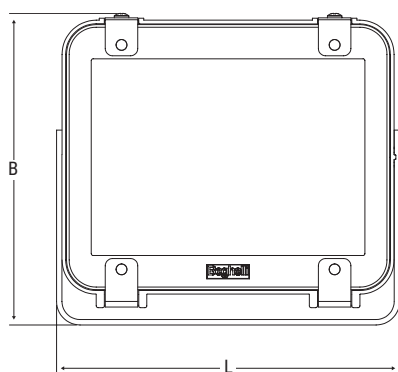

Dimensions mm

L	B	H
190	173	75.5

066

FLOOD MINI ASYMMETRICAL OPTICS

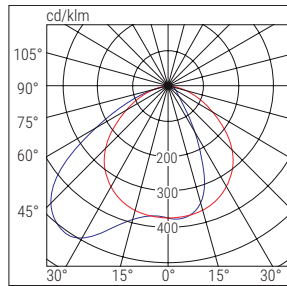

■ C90-C270 ■ C0-C180

FLOOD MINI SYMMETRICAL OPTICS

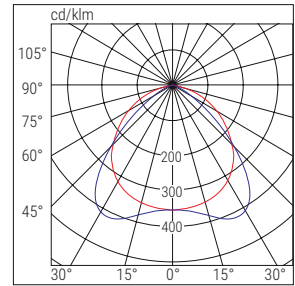

■ C90-C270 ■ C0-C180

	Order Code	Description	Optics	Power W	Colour temp. K	Chromatic yield	LED Flux lm (Tj=25°C)	Luminaire flux lm	Brightness efficiency lm/W	Weight Kg	Packaging Single/Multi pack	
LED	F30LED	PRO LED 1x30W 4K	SYM / ASYM	17	4000	>80	2100	1800	105	1.2	1/8	ON / OFF
	F50LED	PRO LED 1x50W 4K	SYM / ASYM	26	4000	>80	3500	3000	115	1.2	1/8	
	F70LED	PRO LED 1x70W 4K	SYM / ASYM	37	4000	>80	4600	4000	108	1.2	1/8	

ACCESSORIES - included

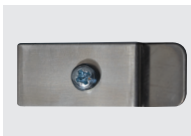

VANDAL-PROOF SCREWS



GONIOMETRIC BRACKET



M20 CABLE GLAND WITH VENT VALVE

ACCESSORIES - to be ordered separately



BUILDING AUTOMATION REMOTE CONTROL RECEIVER

Order Code **20108**

EMERGENCY LED INVERTERS - to be ordered separately



INVERTER PLUG&LIGHT SE/SA 1-3h 20-60V IP65

Order Code **19368** (3h)

TR



LGFM EMERGENCY MODULE
For AT/LG series inverters only

Order Code **19375**

LGFM



INVERTER AT/LG AR 9W 55V
Inverter cover (19376) required for installation

Order Code **19355L** (LiFe battery)

AT LG



INVERTER COVER IP65

Order Code **19376**



INVERTER GL AT/LG AR 15W 55V
Inverter cover (19376) required for installation

Order Code **19391** (LiFe battery)

Order Code **19390** (LTO battery)

AT LG

FH-M



IP66
IK09
960°
SD DERATING +60°C -30°C
RD +40°C -20°C
EMERGENCY +40°C 0°C



Outdoor floodlight with goniometric fixing bracket. Luminous flux up to over 17000 lm.



Available in Smart Driver Auto-dimmable version, controllable from the Central Unit, or with an RD system that has a selector to set 4 steps of luminous flux.



Double aluminium high bay light, both symmetrical and asymmetrical (by removing the deflector).

Applications

Industry, services, residential

Characteristics

Power supply

SD 93÷265 VAC - 50/60Hz 176÷250 VDC

RD 230VAC ±10% 50 Hz

Power supply - MTBF at 25°C 100,000 h

Luminous flux retention at 25°C

>60,000h (110W and 100W) (L80B20)

>70,000h (75W) (L80B20)

>80,000h (50W) (L80B20)

Colour stability 3 SDCM

Mounting Floor, wall, lighthouse towers, suspended, ceiling

Housing Polyester powder-coated die-cast aluminium, RAL 7040

Optics Parabolic blades, made of anti-iridescent polished anodised aluminium. Symmetrical, asymmetrical.

Screen Tempered glass prism, 4mm

Compliance EN 60598-1, EN 60598-2-1, EN 60598-2-22, DIN 18031-3, EN 62471 (photobiological risk-free), 2014/53/EU

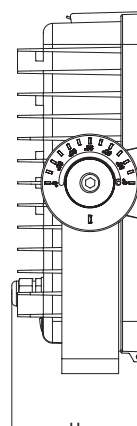
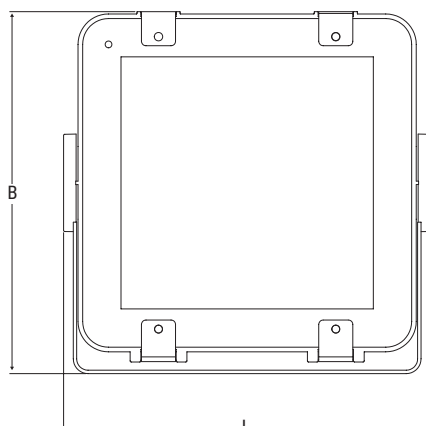

Dimensions mm		
L	B	H
323	319	116

FH-M ASYMMETRIC OPTICS

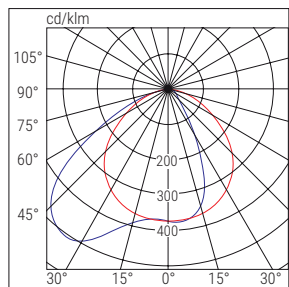

■ C90-C270 ■ C0-C180

FH-M SYMMETRIC OPTICS

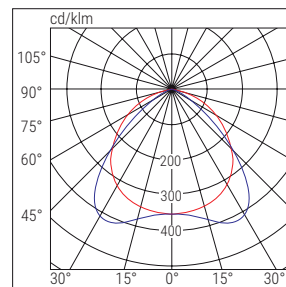

■ C90-C270 ■ C0-C180

	Order Code	Description	Optics	Power W	Colour temp. K	Chromatic yield	LED Flux lm (Tj=25°C)	Luminaire flux lm	Brightness efficiency lm/W	Weight Kg	Packaging Single/ Multi pack	
SD	40807	PRO/RIF 75W SD 4K	Symmetrical/asymmetrical	74	4000	>80	12000	11984	162	4	1	AUTO-DIMMER
	40810	PRO/RIF 110W SD 4K	Symmetrical/asymmetrical	110	4000	>80	18000	16800	153	4	1	
RD	40801	PRO/RIF 50W ADJUSTABLE 4K	Symmetrical/asymmetrical	50	4000	>80	7800	7430	149	4	1	ADJUSTABLE
	40804	PRO/RIF 100W ADJUSTABLE 4K	Symmetrical/asymmetrical	100	4000	>80	15600	14073	141	4	1	

DALI **MODULAR ENCODING:**
 To create the DALI version device code, select a device in the range **RD** and add to its code the suffix **DL**
 Example: Order Code **40801 + DL** = Order Code **40801DL** - NOTE: The power of these luminaires, in the DALI version, is increased as compared to the version **RD**: Order Code 40801DL = 74W; Order Code

RD VERSIONS, MANUALLY ADJUSTABLE FLUX/POWER AT 4 STEPS



Flux/Power	Code 40801			Code 40804		
	lm	W	lm/W	lm	W	lm/W
STEP 1	7430	50	149	14073	100	141
STEP 2	6496	42	155	12464	84	148
STEP 3	5586	35	160	10777	70	154
STEP 4	4561	28	163	8893	56	159

The lighting system must consider both the required level of lighting obtained from the lighting calculation and the power saving needs. The FH-M floodlight allows you to achieve this result thanks to its driver equipped with a 4-step current modulation switch that provides maximum luminous efficiency and, therefore, maximum power saving, while respecting the luminous flux determined in the design phase.

SPECIAL VARIANTS - on request

CHROMATIC YIELD ≥90 - COLOUR TEMPERATURE ON REQUEST
 VERSION WITH POLYCARBONATE DIFFUSER FOR HACCP ENVIRONMENTS (IP54)

ACCESSORIES - included



SD RADIO / 1 -10V INTERFACE

SD



SMART DIMMER LIGHT SENSOR

Order Code **15039**

SD



VANDAL-PROOF SCREWS



GONIOMETRIC BRACKET









M20 CABLE GLAND WITH VENT VALVE

NEXT >

FH-M

lighting

ACCESSORIES - to be ordered separately



	MOUNTING BRACKET FOR ELECTRIFIED BAR Order Code 12659		CEILING MOUNTING BRACKET Order Code 12664
	POLE END CAP 2X 60-76 Order Code 12661		POLE END CAP 4X 60-76 Order Code 12662
	HIGH BAY LIGHT SUSPENSION CABLE Order Code 12663		PROTECTIVE GRID Order Code 12657

BUILDING AUTOMATION - to be ordered separately

	LOGICA SD LGFM CONTROL UNIT Order Code 21102		BUILDING AUTOMATION RADIO TRANSMITTER Order Code 20104
---	---	--	---

LUMINAIRE + EMERGENCY WITH PRE-WIRED LED INVERTER - modular coding

SD

BUILT-IN INVERTER	SUFFIX	EMERGENCY SYSTEM	BATTERY	AUTONOMY (h)	LED POWER (W)
	TR1	STANDARD	NiCd 7.2V 0.75Ah	1	3
	TR3	STANDARD	NiMH 7.2V 1.5Ah	3	3
	ATLG	AT-LG	LiFe 9.6V 1.5Ah	0.75/1/2/3/8	9/7/4/2/1
	LGFM	LGFM	LiFe 9.6V 1.5Ah	0.75/1/2/3/8	9/7/4/2/1
	ATLGGL	AT-LG	LiFe 12.8V 1.5Ah HT	0.75/1/2/3/8	15/10/5/3.3/1.25
	LGFMGL	LGFM	LiFe 12.8V 1.5Ah HT	0.75/1/2/3/8	15/10/5/3.3/1.25

LUMINAIRE + EMERGENCY WITH PRE-WIRED LED INVERTER - modular coding

RD

BUILT-IN INVERTER	SUFFIX	EMERGENCY SYSTEM	BATTERY	AUTONOMY (h)	LED POWER (W)
	TR1	STANDARD	NiCd 7.2V 0.75Ah	1	3
	TR3	STANDARD	NiMH 7.2V 1.5Ah	3	3

Each unit in this series can be **configured and pre-wired directly in Beghelli**, ready for installation.

For orders, create the code by specifying the control system using the following tables:

Order Code LUMINAIRE + SUFFIX, for example, to order an Autotest Logic GranLuce (AT-LG) 110W FH-M floodlight, add to the Order Code 40810 the ending ATLGGL = Order Code 40810ATLGGL



071 outdoor floodlights

FH-L



IP66 **IK09** **960°**
 SD DERATING **+60°C** **-30°C**
 RD **+40°C** **-20°C**
 EMERGENCY **+40°C** **0°C**



Outdoor floodlight with goniometric fixing bracket. Luminous flux up to over 32000lm.



Available in Smart Driver Auto-dimmable version, controllable from the Central Unit, or with an RD system that has a selector to set the LED power at 4 steps of luminous flux.



Double aluminium high bay light, both symmetrical and asymmetrical (by removing the deflector).

Applications

Industry, services, residential

Characteristics

Power supply

SD 93÷265 VAC - 50/60Hz 176÷250 VDC

RD 230VAC ±10% 50 Hz

Power supply - MTBF at 25°C 100,000 h

Luminous flux retention at 25°C

>70,000h (L80B20)

Colour stability 3 SDCM

Mounting Floor, wall, lighthouse towers, suspended

Housing Polyester powder-coated die-cast aluminium, RAL 7040

Optics Parabolic blades, made of anti-iridescent polished anodised aluminium. Symmetrical/asymmetrical.

Screen Tempered glass prism, 4mm

Compliance EN 60598-1, EN 60598-2-1, EN 60598-2-22, DIN 18031-3, EN 62471 (photobiological risk-free), EN 61493, 2014/53/EU

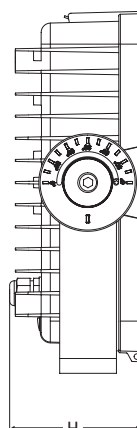
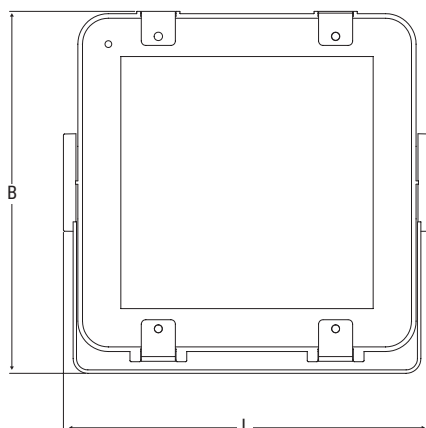

Dimensions mm		
L	B	H
348	434	121

FH-L ASYMMETRIC OPTICS

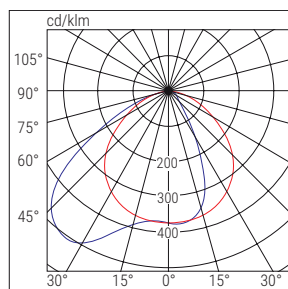

■ C90-C270 ■ C0-C180

FH-L SYMMETRICAL DIFFUSING OPTICS

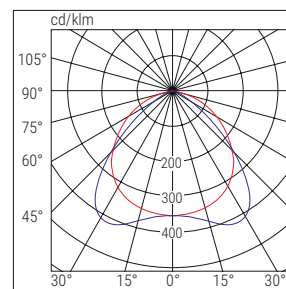

■ C90-C270 ■ C0-C180

	Order Code	Description	Optics	Power W	Colour temp. K	Chromatic yield	LED Flux lm (Tj=25°C)	Luminaire flux lm	Brightness efficiency lm/W	Weight Kg	Packaging Single/Multi pack	
SD	40867	PRO/RIF 150W SD 4K	Symmetrical/asymmetrical	150	4000	>80	27000	24907	166	8.8	1	AUTO-DIMMER
	40870	PRO/RIF 200W SD 4K	Symmetrical/asymmetrical	200	4000	>80	35500	32400	162	8.8	1	
RD	40861	PRO/RIF 150W ADJUSTABLE 4K	Symmetrical/asymmetrical	151	4000	>80	25000	23143	153	8.8	1	ADJUSTABLE
	40864	PRO/RIF 200W ADJUSTABLE 4K	Symmetrical/asymmetrical	203	4000	>80	30500	27878	137	8.8	1	

DALI **MODULAR ENCODING:**
To create the DALI version device code, select a device in the range **RD** and add to its code the suffix **DL**
Example: Order Code **40861 + DL** = Order Code **40861DL**

RD VERSIONS, MANUALLY ADJUSTABLE FLUX/POWER AT 4 STEPS



Flux/Power	Order 40861			Order 40864		
	lm	W	lm/W	lm	W	lm/W
STEP 1	23143	151	153	27878	203	137
STEP 2	20266	128	158	24754	172	144
STEP 3	17380	107	162	21497	143	150
STEP 4	14229	85	167	17769	114	156

The lighting system must consider both the required level of lighting obtained from the lighting calculation and the power saving needs. The FH-L floodlight allows you to achieve this result thanks to its driver equipped with a 4-step current modulation switch that provides maximum luminous efficiency and, therefore, maximum power saving, while respecting the luminous flux determined in the design phase.

SPECIAL VARIANTS - on request

CHROMATIC YIELD ≥ 90 - COLOUR TEMPERATURE ON REQUEST
VERSION WITH POLYCARBONATE DIFFUSER FOR HACCP ENVIRONMENTS (IP54)

ACCESSORIES - included

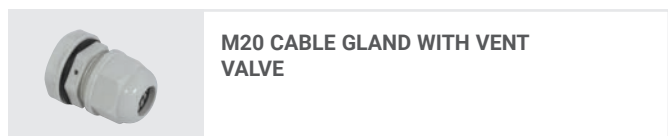
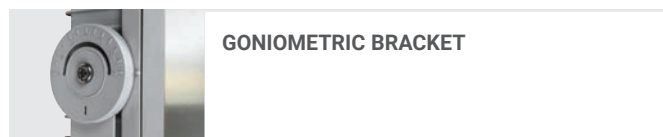
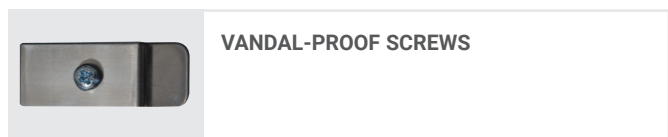
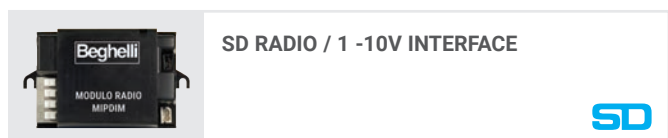







NEXT >

FH-L

lighting

ACCESSORIES - to be ordered separately



	MOUNTING BRACKET FOR ELECTRIFIED BAR Order Code 12659		CEILING MOUNTING BRACKET Order Code 12664
	POLE END CAP 2X 60-76 Order Code 12661		POLE END CAP 4X 60-76 Order Code 12662
	HIGH BAY LIGHT SUSPENSION CABLE Order Code 12663		PROTECTIVE GRID Order Code 12658

BUILDING AUTOMATION - to be ordered separately

	LOGICA SD LGFM CONTROL UNIT Order Code 21102		BUILDING AUTOMATION RADIO TRANSMITTER Order Code 20104
---	---	--	---

LUMINAIRE + EMERGENCY WITH PRE-WIRED LED INVERTER - modular coding

SD

BUILT-IN INVERTER	SUFFIX	EMERGENCY SYSTEM	BATTERY	AUTONOMY (h)	LED POWER (W)
	TR1	STANDARD	NiCd 7.2V 0.75Ah	1	3
	TR3	STANDARD	NiMH 7.2V 1.5Ah	3	3
	ATLG	AT-LG	LiFe 9.6V 1.5Ah	0.75/1/2/3/8	9/7/4/2/1
	LGFM	LGFM	LiFe 9.6V 1.5Ah	0.75/1/2/3/8	9/7/4/2/1
	ATLGGL	AT-LG	LiFe 12.8V 1.5Ah HT	0.75/1/2/3/8	15/10/5/3.3/1.25
	LGFMGL	LGFM	LiFe 12.8V 1.5Ah HT	0.75/1/2/3/8	15/10/5/3.3/1.25

LUMINAIRE + EMERGENCY WITH PRE-WIRED LED INVERTER - modular coding

RD

BUILT-IN INVERTER	SUFFIX	EMERGENCY SYSTEM	BATTERY	AUTONOMY (h)	LED POWER (W)
	TR1	STANDARD	NiCd 7.2V 0.75Ah	1	3
	TR3	STANDARD	NiMH 7.2V 1.5Ah	3	3

Each unit in this series can be **configured and pre-wired directly in Beghelli**, ready for installation.

For orders, create the code by specifying the control system using the following tables:

Order Code LUMINAIRE + SUFFIX, for example, to order an Autotest Logica GranLuce (AT-LG) 200W FH-L floodlight, add to the Order Code 40870 the ending ATLGGL = Order Code 40870ATLGGL

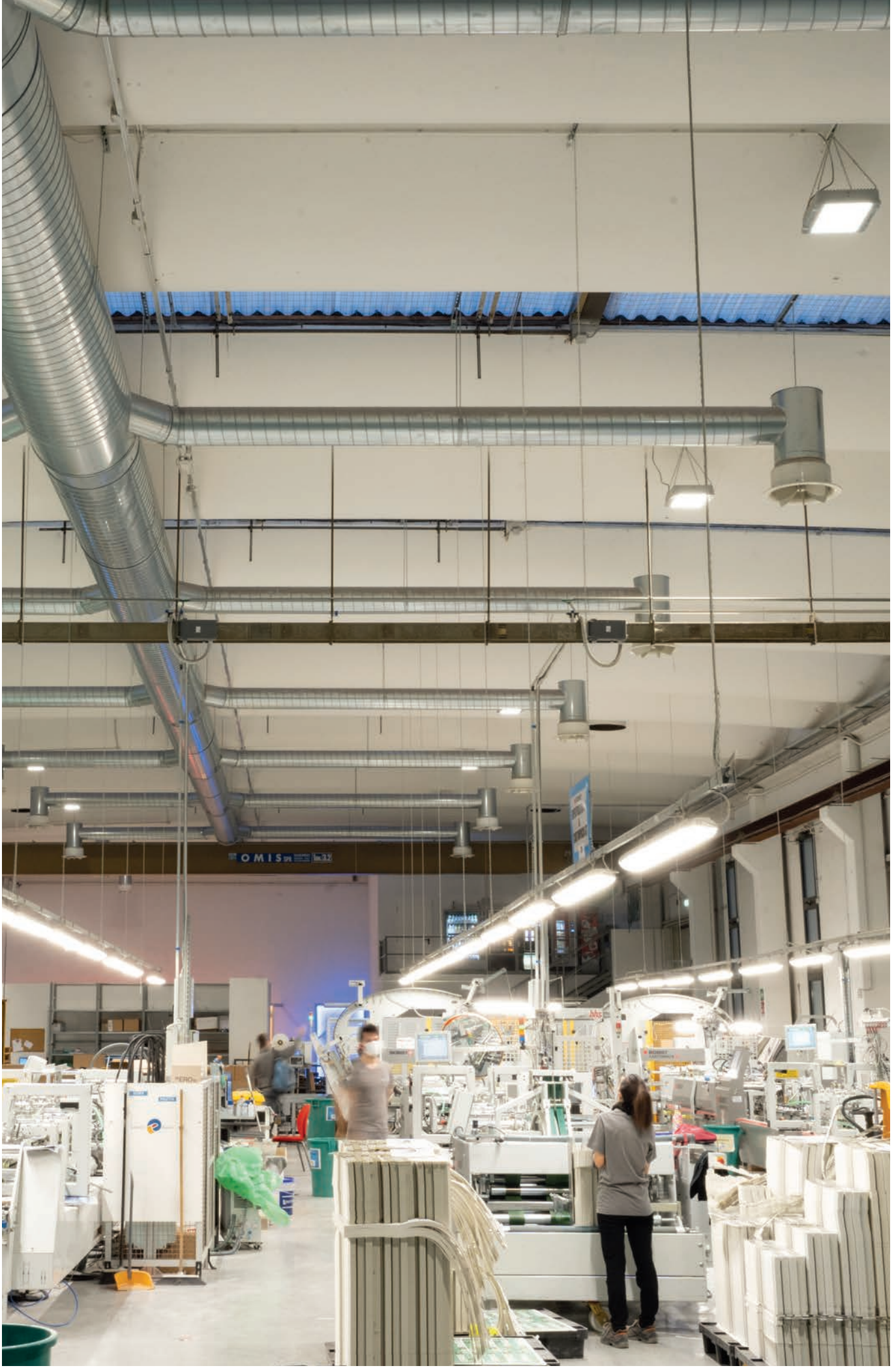

075 outdoor floodlights

Power Light

nuBe



IP66

IK09

960°

+40°C
-20°C



Modular luminaire for lighting large areas. Luminous flux up to 63,000lm.



ED versions with luminous flux control and 0÷10V dimming.



Standard 120° optics, 10°, 30°, 60° optics can be installed on request to meet any design requirement.

Applications

Sports fields, road sections, industrial yards, outdoor car parks

Characteristics

Power supply 100~305 VAC 50/60 Hz with 10KV overvoltage protection

Power supply - MTBF at 25°C 100,000h

Luminous flux retention at 25°C
>50,000h (L70B20)

Colour stability 3 SDCM

Mounting Lighthouse tower, wall, pole, floor

Housing Polyester powder-coated die-cast aluminium, black

Lenses clear PMMA

Compliance EN 60598-1, EN 60598-2-22 DIN 18031-3, EN 62471 (Biological risk-free), EN 60598-2-5, 2014/53/EU

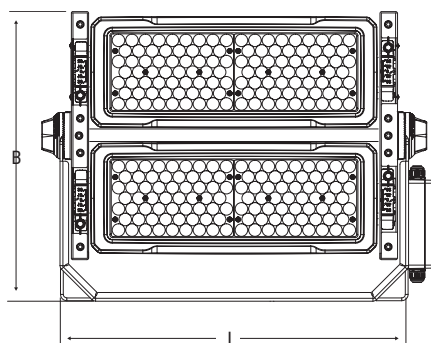

300-400W VERSION

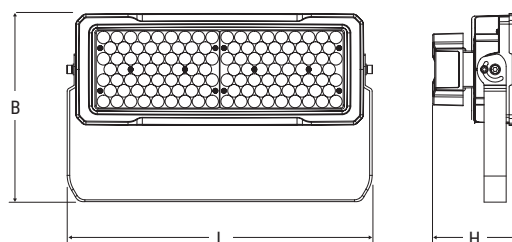
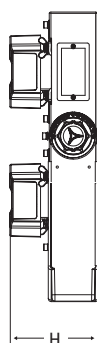

250W Version

Version	Dimensions mm		
	L	B	H
250-300W	438	296	135
400W	510	453	137

250W VERSION

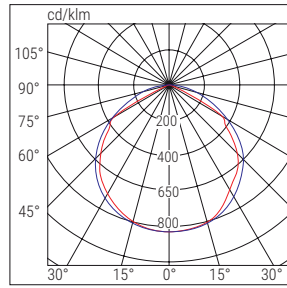

■ C0-C180 ■ C90-C270

300-400W VERSION

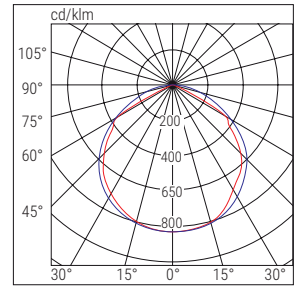

■ C180-C270 ■ C90-C270

	Order Code	Description	Optics	Power W	Colour temp. K	Chromatic yield	LED Flux lm (Tj=25°C)	Luminaire flux lm	Brightness efficiency lm/W	Weight Kg	Packaging Single/Multi pack	Notes and compliance
SD	40748	POWER L 250W 120° C70 SD 4K	120°	250	4000	>70	39000	32500	130	6.6	1	AUTO-DIMMER
	40749	POWER L 300W 120° C70 SD 4K	120°	300	4000	>70	47000	39000	130	18.5	1	
	40750	POWER L 400W 120° C70 SD 4K	120°	400	4000	>70	62500	52000	130	18.5	1	
ED	40716	POWER L 250W 120° C70 ED 4K 0-10V	120°	250	4000	>70	39000	32500	130	6.6	1	ON / OFF - 0 -10V
	40717	POWER L 300W 120° C70 ED 4K 0-10V	120°	300	4000	>70	47000	39000	130	18.5	1	
	40718	POWER L 400W 120° C70 ED 4K 0-10V	120°	400	4000	>70	62500	52000	130	18.5	1	
DALI	MODULAR ENCODING: To create the DALI version device code, select a device in the range ED and add to its code the suffix DL Example: Order Code 40716 + DL = Order code 40716DL											DALI

SPECIAL VARIANTS - on request

COLOUR TEMPERATURE ON REQUEST (5000K) - WATTAGES (500-600-750-1000-1250W-1500W) - OPTICS COLOUR RENDERING (10°, 30°, 60°, ASYMMETRICAL, ELLIPTICAL)

ACCESSORIES - included



SD RADIO / 1 -10V INTERFACE





M20 CABLE GLAND WITH VENT VALVE



GONIOMETRIC BRACKET

ACCESSORIES - to be ordered separately



250-300W CURVED BRACKET

Order Code **40930**



POLE MOUNT

Order Code **40932**



400W CURVED BRACKET

Order Code **40931**



LASER POINTER



Order Code **40933**

BUILDING AUTOMATION - to be ordered separately



LOGICA SD LGFM CONTROL UNIT

Order Code **21102**



BUILDING AUTOMATION RADIO TRANSMITTER

Order Code **20104**



H-PRO

lighting



IP66

IK09

960°

SD DERATING
+60°C
-30°C

RD
+40°C
-20°C

EMERGENCY
+40°C
0°C



High luminous flux high bay light with a luminous flux of more than 40000 lm, equipped with an eye bolt for suspension.



Available in Self-dimming Smart Driver version, controllable from the control unit, or 0÷10V preconfigured to manage 4 classes of luminous flux.



Blade optics with three different beam patterns: Diffusing, Concentrating, Elliptical.

Applications

Industry, logistics warehouses, hangars

Characteristics

Power supply

93÷265 VAC - 50/60Hz 176÷250 VDC

Power supply - MTBF at 25°C 100,000h

Luminous flux retention at 25°C

>60,000h (240W) (L80B20)

>70,000h (150W) (L80B20)

Colour stability 3 SDCM

Mounting Floor, wall, lighthouse towers

Housing Polyester powder-coated die-cast aluminium, RAL 7040

Optics Parabolic blades, made of anti-iridescent polished anodised aluminium. Diffusing, concentrating, elliptical.

Screen Tempered glass prism, 4mm

Compliance EN 60598-1, EN 60598-2-1, EN 60598-2-22, DIN 18031-3, EN 62471 (photobiological risk-free), 2014/53/EU

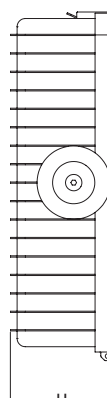
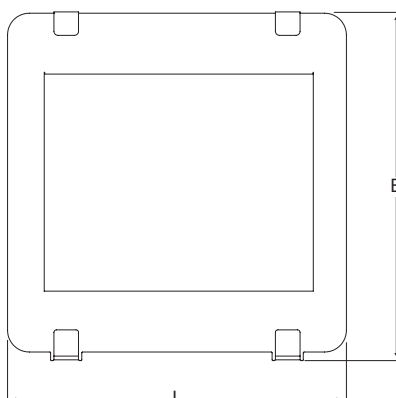

Dimensions mm

L	B	H
436	434	121

078

DIFFUSED OPTICS

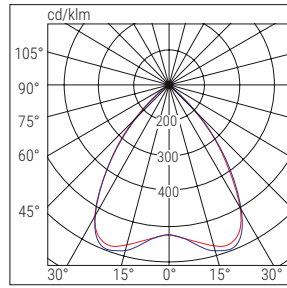
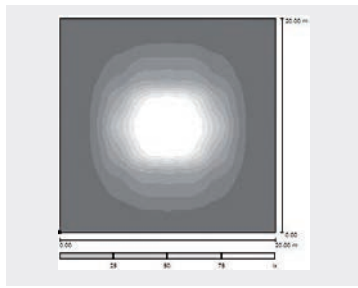

■ C90-C270 ■ C0-C180

ELLIPTICAL OPTICS

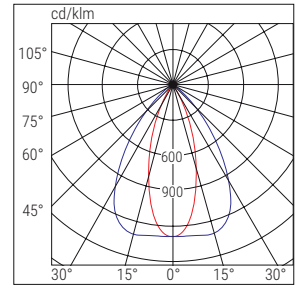
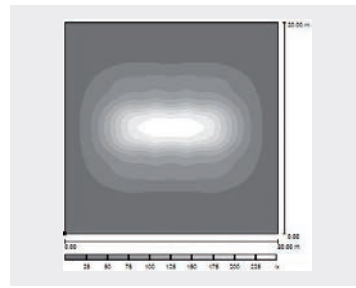

■ C90-C270 ■ C0-C180

CONCENTRATING OPTICS

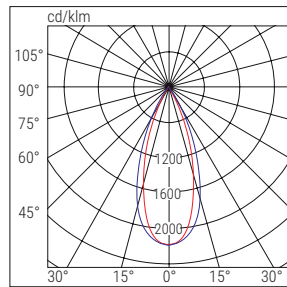
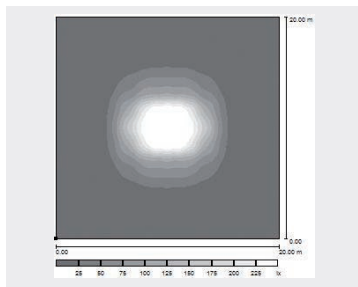

■ C90-C270 ■ C0-C180

	Order Code	Description	Optics	Power W	Colour temp. K	Chromatic yield	LED Flux lm (Tj=25°C)	Luminaire flux lm	Brightness efficiency lm/W	Weight Kg	Packaging Single/ Multi pack
SD	40839	RIF S 150W D SD 4K	DIFFUSING	153	4000	>80	27000	22824	149	7.7	1
	40842	RIF S 150W C SD 4K	CONCENTRATING	153	4000	>80	27000	21683	142	7.7	1
	40845	RIF S 150W E SD 4K	ELLIPTICAL	153	4000	>80	27000	22140	145	7.7	1
	40848	RIF S 240W D SD 4K	DIFFUSING	246	4000	>80	47000	38853	158	7.7	1
	40851	RIF S 240W C SD 4K	CONCENTRATING	246	4000	>80	47000	38005	154	7.7	1
	40854	RIF S 240W E SD 4K	ELLIPTICAL	246	4000	>80	47000	38638	157	7.7	1
RD	40821	RIF S 150W D ADJUSTABLE 010 4K	DIFFUSING	153	4000	>80	27000	22824	149	7.7	1
	40824	RIF S 150W C ADJUSTABLE 010 4K	CONCENTRATING	153	4000	>80	27000	21683	142	7.7	1
	40827	RIF S 150W E ADJUSTABLE 010 4K	ELLIPTICAL	153	4000	>80	27000	22140	145	7.7	1
	40830	RIF S 240W D ADJUSTABLE 010 4K	DIFFUSING	246	4000	>80	47000	40005	163	7.7	1
	40833	RIF S 240W C ADJUSTABLE 010 4K	CONCENTRATING	246	4000	>80	47000	38005	155	7.7	1
	40836	RIF S 240W E ADJUSTABLE 010 4K	ELLIPTICAL	246	4000	>80	47000	38805	158	7.7	1

DALI MODULAR ENCODING:
To create the DALI version device code, select a device in the range **RD** and add to its code the suffix **DL**
Example: Order Code 40821 + DL = Order Code 40821DL

DIFFUSING RD VERSIONS, WITH MANUALLY ADJUSTABLE FLUX/POWER IN 4 STEPS



Flux/Power	153W			246W		
	lm	W	lm/W	lm	W	lm/W
STEP 1	22824	153	149	40005	246	163
STEP 2	19623	129	152	33507	200	168
STEP 3	16398	105	156	27994	162	173
STEP 4	13779	87	158	23575	133	177

Diagram referring only to the DIFFUSING version with 4 current modulation steps to ensure maximum lighting efficiency. For data on the other versions (CONCENTRATING and ELLIPTICAL), please refer to the on-line catalogue.

NEXT >

H-PRO

lighting

SPECIAL VARIANTS - on request

CHROMATIC YIELD ≥ 90 - COLOUR TEMPERATURE ON REQUEST - VERSION WITH POLYCARBONATE DIFFUSER FOR HACCP ENVIRONMENTS (IP54)

ACCESSORIES - included



SD RADIO / 1 -10V INTERFACE

Order Code **15039**



SMART DIMMER LIGHT SENSOR

Order Code **15039**



M20 CABLE GLAND WITH VENT VALVE



VANDAL-PROOF SCREWS

ACCESSORIES - to be ordered separately



MOUNTING BRACKET FOR ELECTRIFIED BAR

Order Code **12659**



CEILING MOUNTING BRACKET

Order Code **12664**



HIGH BAY LIGHT SUSPENSION SYSTEM

Order Code **12663**



PROTECTIVE GRID

Order Code **12658**



GONIOMETRIC BRACKET



Order Code **12666**

BUILDING AUTOMATION - to be ordered separately



LOGICA SD LGFM CONTROL UNIT

Order Code **21102**





BUILDING AUTOMATION RADIO TRANSMITTER

Order Code **20104**





LUMINAIRE + EMERGENCY WITH PRE-WIRED LED INVERTER - modular coding

SD

BUILT-IN INVERTER	SUFFIX	EMERGENCY SYSTEM	BATTERY	AUTONOMY (h)	LED POWER (W)
	TR1	STANDARD	NiCd 7.2V 0.75Ah	1	3
	TR3	STANDARD	NiMH 7.2V 1.5Ah	3	3
	ATLG	AT-LG	LiFe 9.6V 1.5Ah	0.75/1/2/3/8	9/7/4/2/1
	LGFM	LGFM	LiFe 9.6V 1.5Ah	0.75/1/2/3/8	9/7/4/2/1
	ATLGGL	AT-LG	LiFe 12.8V 1.5Ah HT	0.75/1/2/3/8	15/10/5/3.3/1.25
	LGFMGL	LGFM	LiFe 12.8V 1.5Ah HT	0.75/1/2/3/8	15/10/5/3.3/1.25

LUMINAIRE + EMERGENCY WITH PRE-WIRED LED INVERTER - modular coding

RD

BUILT-IN INVERTER	SUFFIX	EMERGENCY SYSTEM	BATTERY	AUTONOMY (h)	LED POWER (W)
	TR1	STANDARD	NiCd 7.2V 0.75Ah	1	3
	TR3	STANDARD	NiMH 7.2V 1.5Ah	3	3
	ATLG	AT-LG	LiFe 9.6V 1.5Ah	0.75/1/2/3/8	9/7/4/2/1
	LGFM	LGFM	LiFe 9.6V 1.5Ah	0.75/1/2/3/8	9/7/4/2/1
	ATLGGL	AT-LG	LiFe 12.8V 1.5Ah HT	0.75/1/2/3/8	15/10/5/3.3/1.25
	LGFMGL	LGFM	LiFe 12.8V 1.5Ah HT	0.75/1/2/3/8	15/10/5/3.3/1.25

Each luminaire in this series can be **configured and pre-wired directly in production**, ready for installation.

For orders, create the code by specifying the control system using the following tables:

Order Code LUMINAIRE + SUFFIX, for example, to order an Autotest Logica GranLuce (AT-LG) 150W H-PRO high bay light, add to the Order Code 40839 the suffix ATLGGL = Order Code 40839ATLGGL

Highbay HP

lighting

nuBe



IP65

IK09

960°

+50°C
-25°C



High-performance high bay light with a luminous efficacy of 140 lm/W suitable for replacing older high bay luminaires in industrial environments.



PMMA diffuser available with 120° beam angle for a diffusing beam, also available are concentrating bells for 60° and 90° angles.

Applications

Industry, logistics warehouses, hangars

Characteristics

Power supply

93÷265 VAC - 50/60Hz 176÷250 VDC

Power supply - MTBF at 25°C 100,000h

Luminous flux retention at 25°C

>50,000h (L80B20)

Colour stability 3 SDCM

Mounting Suspended, ceiling, wall, floor

Housing Polyester powder-coated die-cast aluminium, RAL 7040

Optics Round PMMA Lens

Compliance EN60598-1, EN60598-2-1, EN 62471, 2014/53/EU, EN60598-2-22, DIN 18031-3

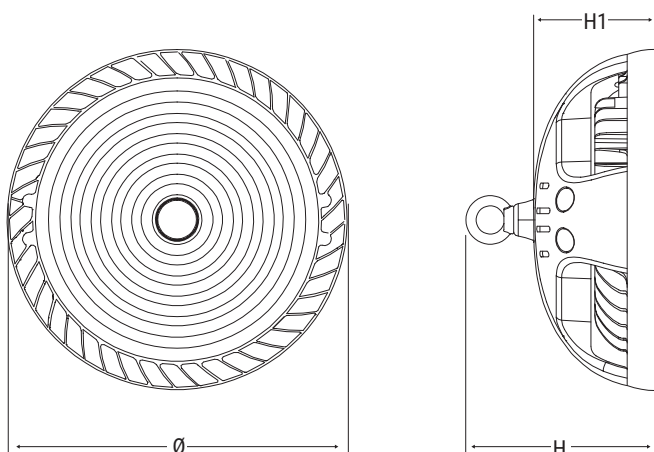

Version	Order code	Dimensions mm		
		H	H1	Ø
SD	40224-40225	207	148	300
	40226-40227	229	165	360
ED	40204-40205	167	108	300
	40206-40207	189	125	360

240W VERSION

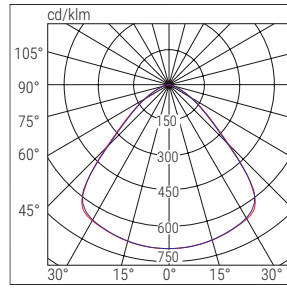

■ C0-C180 ■ C90-C270

	Order Code	Description	Power W	Colour temp. K	Chromatic yield	LED Flux lm (Tj=25°C)	Luminaire flux lm	Brightness efficiency lm/W	Weight Kg	Packaging Single/ Multi pack	Notes and compliance
SD	40224	HIGHBAY HP 100W 90° 4K SD	100	4000	≥80	16500	14000	140	3.9	1	90° Optics
	40225	HIGHBAY HP 150W 90° 4K SD	150	4000	≥80	25000	21000	140	4.5	1	90° Optics
	40226	HIGHBAY HP 200W 90° 4K SD	200	4000	≥80	33000	28000	140	7.0	1	90° Optics
	40227	HIGHBAY HP 240W 90° 4K SD	240	4000	≥80	40000	34000	142	7.5	1	90° Optics
ED	40204	HIGHBAY HP 100W 90°0-10V 4K ED	100	4000	≥80	16500	14000	140	4.2	1	90° Optics
	40205	HIGHBAY HP 150W 90°0-10V 4K ED	150	4000	≥80	25000	21000	140	4.8	1	90° Optics
	40206	HIGHBAY HP 200W 90°0-10V 4K ED	200	4000	≥80	33000	28000	140	7.4	1	90° Optics
	40207	HIGHBAY HP 240W 90°0-10V 4K ED	240	4000	≥80	40000	34000	142	7.9	1	90° Optics

(*) Function that can be activated by integrating the optional external light sensor Code 21100

ACCESSORIES - included



SD RADIO / 1 -10V INTERFACE





EYE-BOLT FOR SUSPENDED MOUNTING

ACCESSORIES - to be ordered separately



GLASS DIFFUSER HP 120°

Order Code **40900** (100/150W)
Order Code **40901** (200/240W)



BELL 70° HP

Order Code **40904** (100/150W)
Order Code **40905** (200/240W)



DIFFUSER HP 120° 100/150W

Order Code **40902** (100/150W)
Order Code **40903** (200/240W)



BELL 90° HP

Order Code **40906** (100/150W)
Order Code **40907** (200/240W)



SWIVEL BRACKET HP



Order Code **40908** (100/150W)
Order Code **40909** (200/240W)

BUILDING AUTOMATION - to be ordered separately



LOGICA SD LGFM CONTROL UNIT

Order Code **21102**



BUILDING AUTOMATION RADIO TRANSMITTER

Order Code **20104**



Strada

lighting

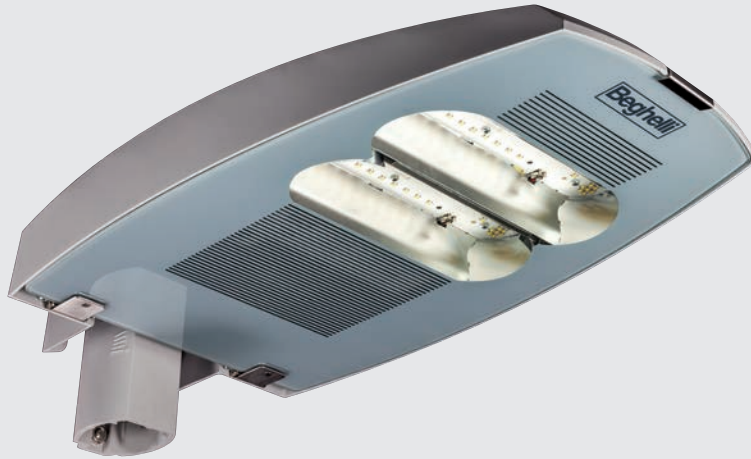

- IP66
- IK09
- ∧ 960°
-
- +40°C
-20°C



Street furniture with centralised control management, in harmony with the new smart city concept.

Applications

Public and private roads, car parks, cycle paths

Characteristics

Power supply 93÷265 VAC - 50/60Hz
176÷250 VDC with 10KV overvoltage protection and adjustable LED current (max 77ma)

Power supply - MTBF a 25°C 80,000 h

Luminous flux retention at 25°C

>70,000h (S70, S100, S150) (L80B20)

>75,000h (S30, S50) (L80B20)

Colour stability 3 SDCM

Mounting Pole or arm Φ60 mm

Housing Polyester powder-coated die-cast aluminium, RAL 7040

Optics Parabolic blades, made of anti-iridescent polished anodised aluminium. Suburban and urban roads (ME2, ME3A, ME3B, ME4A, ME4B, ME5, ME6) and cycle paths (CE, S)

Screen Tempered glass, 5mm thick

Compliance EN 60598-1, EN 60598-2-3, EN 60598-2-22, EN 62471 (photobiological-risk free), 2014/53/EU

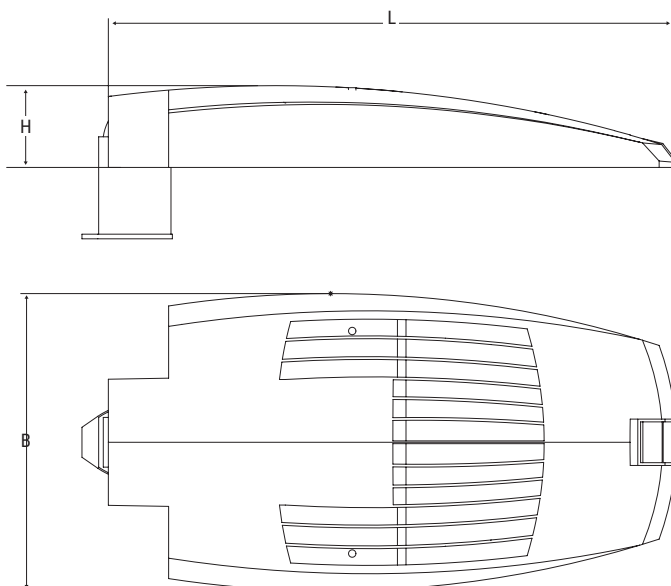

Dimensions mm

L	B	H
611	320	88

URBAN/EXTRA-URBAN STREET OPTICS

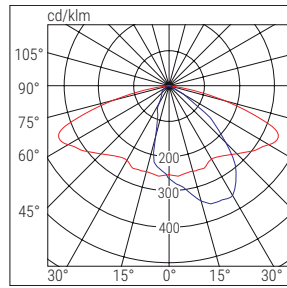

■ C0-C180 ■ C90-C270

LONG BEAM URBAN/EXTRA-URBAN OPTICS

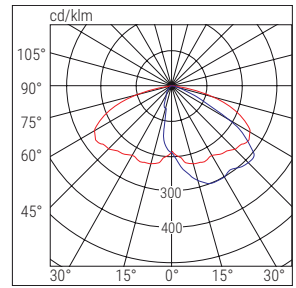

■ C0-C180 ■ C90-C270

URBAN/CYCLING PATH/PARKING OPTICS

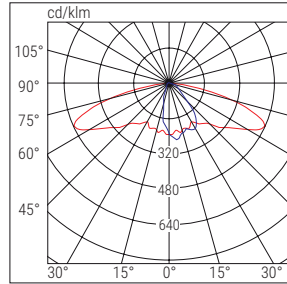

■ C0-C180 ■ C90-C270

	Order Code	Description	Optics	Power W	Colour temp. K	Chromatic yield	LED Flux lm (Tj=25°C)	Luminaire flux lm	Brightness efficiency lm/W	Weight Kg	Packaging Single/Multi pack	Notes and compliance
SD	S50EXSD	STRA LED EX 1x50 SD 4K	EXTRA-URBAN STREET	34	4000	>70	5750	4750	140	1/1	1	
	S70EXSD	STRA LED EX 1x70 SD 4K	EXTRA-URBAN STREET	51	4000	>70	8000	7000	138	1/1	1	
	S100EXSD	STRA LED EX 1x100 SD 4K	EXTRA-URBAN STREET	72	4000	>70	12500	9950	138	1/1	1	
	S150EXSD	STRA LED EX 1x150 SD 4K	EXTRA-URBAN STREET	103	4000	>70	15850	13900	135	1/1	1	
	S250EXSD	STRA LED EX 1x250 SD 4K	EXTRA-URBAN STREET	130	4000	>70	20600	16900	130	1/1	1	
	S50EXLSD	STRA LED EX LONG 1x50 SD 4K	EX-URBAN STREET LONG BEAM	34	4000	>70	5750	4750	140	1/1	1	
	S70EXLSD	STRA LED EX LONG 1x70 SD 4K	EX-URBAN STREET LONG BEAM	51	4000	>70	8000	7000	138	1/1	1	
	S100EXLSD	STRA LED EX LONG 1x100 SD 4K	EX-URBAN STREET LONG BEAM	72	4000	>70	12500	9950	138	1/1	1	
	S150EXLSD	STRA LED EX LONG 1x150 SD 4K	EX-URBAN STREET LONG BEAM	103	4000	>70	15850	13900	135	1/1	1	
	S250EXLSD	STRA LED EX LONG 1x250 SD 4K	EX-URBAN STREET LONG BEAM	130	4000	>70	20600	16900	130	1/1	1	
	S30UCSD	STRA LED UC 1x30 SD 4K	URBAN CYCLING/PARK	24	4000	>70	4000	3300	138	1/1	1	
	S50UCSD	STRA LED UC 1x50 SD 4K	URBAN CYCLING/PARK	34	4000	>70	5200	4600	135	1/1	1	
	S70UCSD	STRA LED UC 1x70 SD 4K	URBAN CYCLING/PARK	48	4000	>70	8450	6500	135	1/1	1	
	S100UCSD	STRA LED UC 1x100 SD 4K	URBAN CYCLING/PARK	66	4000	>70	12000	8900	135	1/1	1	

DALI **INTERFACING WITH ACCESSORY TO BE ORDERED SEPARATELY:**
 It is possible to create DALI luminaires by integrating the version **SD** with the accessory **Dali Module** Order Code **15024**
 Example: Order Code **S50EXSD + 15024** = Luminaire **S50EXSD** in the **DALI** version

Strada

lighting

ACCESSORIES - included



M20 CABLE GLAND WITH VENT VALVE

BUILDING AUTOMATION - to be ordered separately



LOGICA SD LGFM CONTROL UNIT



Order Code 21102

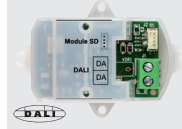

DALI MODULE

Order Code 15024



BUILDING AUTOMATION RADIO TRANSMITTER

Order Code 20104

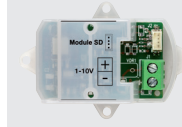

1-10V MODULE

Order Code 15034



BUILDING AUTOMATION RADIO MODULE

Order Code 15022





087 street lighting

Centrostrada

lighting

nuBe

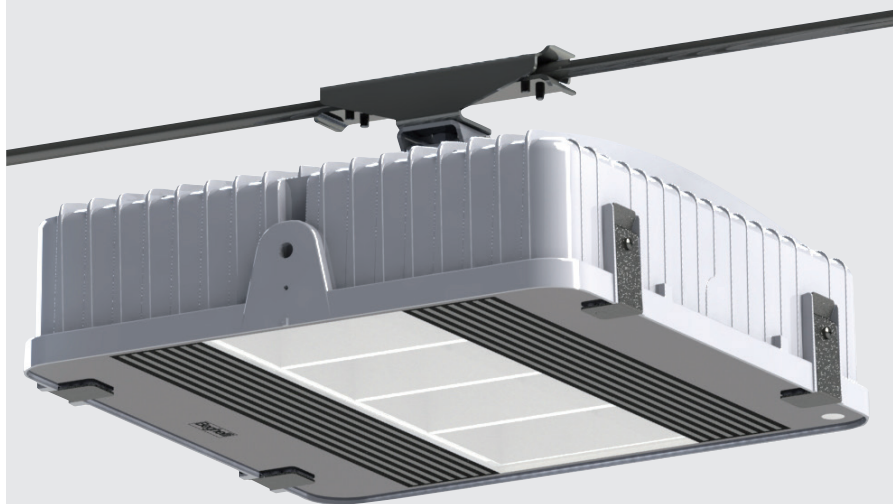

IP66

IK09

∠960°



+40°C
-20°C



Street furniture with centralised control management, in harmony with the new smart city concept. Characterised by high mechanical and chemical resistance. Luminaire designed to withstand vibration and magnetic disturbance.

Applications

Public and private roads, car parks, cycle paths

Characteristics

Power supply Universal Multi Voltage
93÷265 VAC - 50/60Hz, 176÷250 VDC

Power supply - MTBF at 25°C 100,000h

Luminous flux retention at 25°C
80,000h (L80B20)

Colour stability 3 SDCM

Mounting Stretched cable suspension

Housing Polyester powder-coated die-cast aluminium, RAL 7040

Optics Parabolic blades, made of anti-iridescent polished anodised aluminium.

Screen Tempered glass prism, 4mm thick

Compliance EN 60598-1, EN 60598-2-3, EN 60598-2-22, EN 62471 (photobiological risk-free), 2014/53/EU

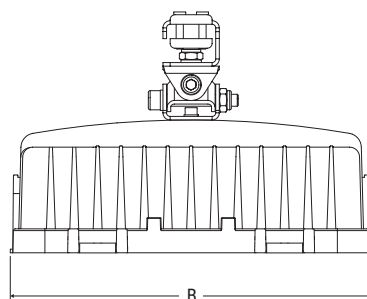
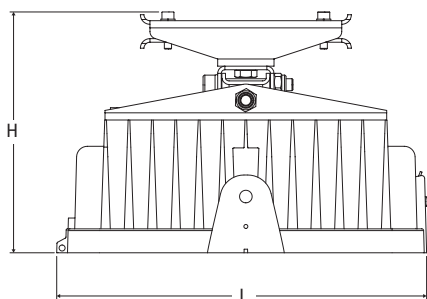

Version	Dimensions mm		
	L	B	H
50/70W	309	302	201
100/150/250W	425	417	221

URBAN OPTICS

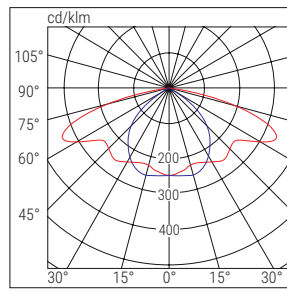

■ C0-C180 ■ C90-C270

	Order Code	Description	Power W	Colour temp. K	Chromatic yield	LED Flux lm (Tj=25°C)	Luminaire flux lm	Brightness efficiency lm/W	Weight Kg	Packaging Single/Multi pack	Notes and compliance
SD	CS50SD	CENTROSTRADA LED 1x50 SD 4K	35	4000	>80	5300	4400	126	5.5	1/1	
	CS70SD	CENTROSTRADA LED 1x70 SD 4K	50	4000	>80	7600	6200	124	5.5	1/1	
	CS100SD	CENTROSTRADA LED 1x100 SD 4K	70	4000	>80	10400	8600	124	7.7	1/1	
	CS150SD	CENTROSTRADA LED 1x150 SD 4K	100	4000	>80	14500	12000	120	7.7	1/1	
	CS250SD	CENTROSTRADA LED 1x250 SD 4K	130	4000	>80	18500	15000	115	7.7	1/1	

DALI **INTERFACING WITH ACCESSORY TO BE ORDERED SEPARATELY:**
 It is possible to create DALI luminaires by integrating the version **SD** with the accessory **Dali Module** Order Code **15024**
 Example: Order Code **CS50SD + 15024** = Luminaire **CS50SD** in the **DALI** version **DALI**

SPECIAL VARIANTS - on request

LG24 - LG230

ACCESSORIES - included

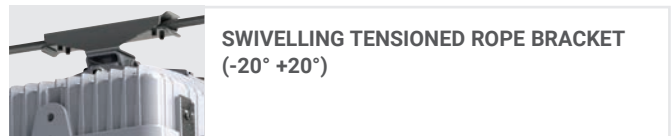
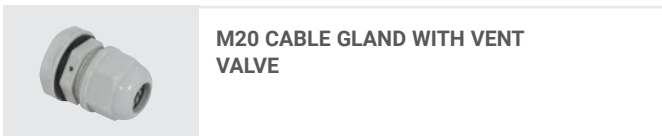

ACCESSORIES - to be ordered separately





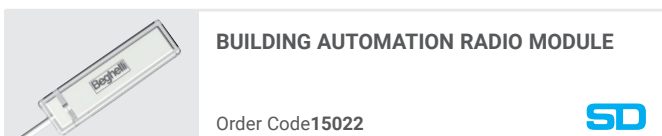
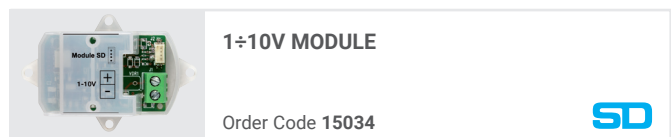
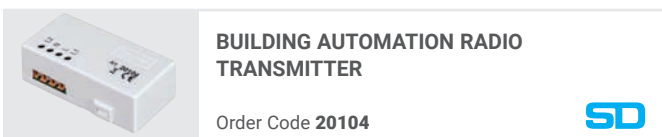
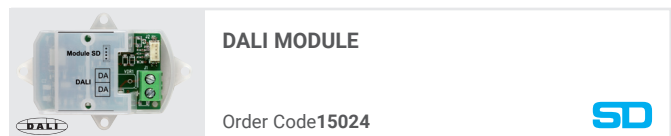
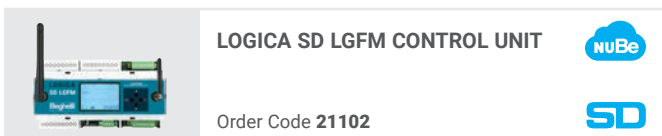



















BUILDING AUTOMATION - to be ordered separately



Key to symbols

GENERAL CHARACTERISTICS: MEANING OF SYMBOLS

SYMBOL	DESCRIPTION	SYMBOL	DESCRIPTION
	Single cloud platform for the remote management of all lighting and emergency lighting systems.		SanificaAria series hybrid luminaires incorporating a UV-C flow cell air sanitisation system.
	Luminaires with an SD-X Smart Driver, which can be integrated with various additional modules that expand the communication features (Radio, 1-10V, Dali) as well as the possibility of directly connecting the Plug&Light inverter, without affecting the protection features. The luminaire with this symbol has an integrated smart photocell with Auto-dimmer function.		General description defining the type of luminaire.
	Luminaires with Smart Driver with integrated SD radio interface and already prepared to communicate with the LGFM SD Logic Control Unit. These luminaires also have a 1-10V interface and a smart light sensor with Auto-dimmer function.		Luminaires with special features for versatility of use.
	Luminaires with an SD-X Smart Driver, which can be integrated with various additional modules that expand the communication features (Radio, 1-10V, Dali) as well as the possibility of directly connecting the Plug&Light inverter, without affecting the protection features.		Luminaires with special lighting characteristics. High luminous flux and beam control.
	Luminaires with Smart Driver with integrated SD radio interface and already prepared to communicate with the LGFM SD Logic Control Unit. These luminaires also have a 1-10V interface.		Luminaires with special mounting solutions, in terms of installation speed and/or multiple connections or through-wiring.
	Luminaires with Smart Driver.		Luminaire with a HCL-CCT module, in both SD and RD versions, for automatic colour temperature variation according to the time of day (Biodynamic lighting), or fixed setting by selecting one of the 4 pre-set values from the switch.
	Luminaires with a driver adjustable in 4 power steps to modulate the luminous flux. These luminaires have flux setting switches.		Protection rating against external factors according to EN 60598-1. If it is double, highlight two versions of the luminaire or a specific optional accessory.
	Luminaires with a 0-10V standard LED Driver with fixed or dimmable lighting.		Protection rating against impact according to EN 50102.
	Luminaires with DALI communication protocol		Resistance temperature of the luminaire at the Glow Wire Test according to IEC EN 60598-1.
	Device that integrates the luminaire with emergency lighting, in the standard TR version For more information, see the Emergency section		Luminaires in which protection against electric shock is guaranteed by an Insulation Class II built.
	Device that integrates the luminaire with emergency lighting, in the self-testing AT version. For more information, see the Emergency section.		General temperature range in which the luminaire maintains its characteristics correctly.
	Device that integrates the luminaire with emergency lighting, in the Logica LG version. For more information, see the Emergency section.		Colour rendering index.
	Device that integrates the luminaire with emergency lighting, in the LGFM Radio Logica version. For more information, see the Emergency section.		Anti-glare index.
			European quality label. Voluntary certification to testify to the quality of the product and the production chain.
			Luminaire intended for use in areas where there is a risk of explosion due to the presence of explosive substances (dust and/or gas...) according to the ATEX Directive .
			Luminaires with no visible flicker and reduced stroboscopic effect. The CIE TN006:2016 f<80Hz and CIE TN006:2016 f<200Hz standards define limit values and measurement methods and do not allow empirical verifications (cameras, smartphones, etc.). Strobe effects can only be detected on moving parts. For more information, visit www.beghelli.it

Analytical index

LUMINAIRES

Order Code	Price €	Page	Order Code	Price €	Page	Order Code	Price €	Page
118SD	123.80	053	40167	143.17	019	40531	243.34	042
136SD	136.75	053	40168	202.79	019	40532	243.34	042
158SD	149.82	053	40171	138.02	019	40533	243.34	042
170ED3	51.05	037	40171UV	934.00	013	40534	243.34	042
170EDMC	76.00	037	40174	162.74	019	40535	243.34	042
170SD3	115.81	037	40176	203.94	019	40536	243.34	042
218SD	130.12	053	40176UV	998.00	013	40600	59.14	042
226ED4	43.79	037	40177	234.84	019	40601	94.64	042
226EDMC	66.03	037	40178	318.78	019	40602	94.64	042
226SD4	108.56	037	40181	230.51	019	40603	108.15	042
236PSD	184.74	053	40204	270.38	083	40604	116.60	042
236SD	148.14	053	40205	321.36	083	40605	113.20	042
258SD	165.04	053	40206	428.48	083	40606	116.60	042
280SD	224.19	053	40207	482.04	083	40607	141.94	042
11288ED	255.46	063	40224	346.08	083	40608	150.39	042
11288PED	213.51	063	40225	400.16	083	40609	175.74	042
11288PSD	269.46	063	40226	508.31	083	40716	865.20	077
11288SD	369.92	063	40227	562.38	083	40717	1,081.50	077
11289ED	323.43	063	40304	97.34	035	40718	1,405.95	077
11289SD	408.13	063	40305	118.97	035	40748	973.35	077
26706	750.00	017	40306	129.78	035	40749	1,189.65	077
40003	52.89	053	40307	173.04	035	40750	1,514.10	077
40004	69.72	053	40324	146.00	035	40801	143.17	069
40005	81.81	053	40325	167.63	035	40804	191.29	069
40101	84.62	029	40326	178.45	035	40807	360.62	069
40104	106.05	029	40327	221.71	035	40810	429.94	069
40107	133.90	029	40500	43.26	042	40821	373.22	079
40110	155.32	029	40501	70.30	042	40824	409.33	079
40113	128.70	027	40503	70.30	042	40827	409.33	079
40116	140.60	027	40504	112.48	042	40830	492.93	079
40119	178.45	027	40505	112.48	042	40833	540.63	079
40122	189.26	027	40510	173.04	042	40836	540.63	079
40131	66.48	023	40511	173.04	042	40839	597.87	079
40134	115.77	023	40512	173.04	042	40842	653.43	079
40137	140.75	023	40513	173.04	042	40845	653.43	079
40140	151.92	023	40514	173.04	042	40848	782.04	079
40143	196.74	023	40515	173.04	042	40851	855.42	079
40146	238.37	023	40516	173.04	042	40854	855.42	079
40151	50.99	019	40517	194.67	042	40861	286.01	073
40154	71.07	019	40518	194.67	042	40864	337.37	073
40157	124.44	019	40519	194.67	042	40867	531.79	073
40161	66.95	019	40520	194.67	042	40870	738.72	073
40161UV	865.00	013	40521	194.67	042	A136ESD	147.62	057
40164	91.67	019	40522	194.67	042	A158ESD	155.44	057
40166	112.27	019	40523	194.67	042	A236ED	110.50	057
40166UV	909.00	013	40530	243.34	042			

NEXT >

Analytical index

LUMINAIRES

Order Code	Price €	Page
A236ESD	167.93	057
A236EXSD	237.49	061
A258ED	119.16	057
A258ESD	186.68	057
A258EXSD	262.36	061
A280ESD	235.59	057
A280EXSD	317.39	061
CS100SD	809.09	089
CS150SD	931.39	089
CS250SD	1,023.11	089
CS50SD	686.77	089
CS70SD	723.24	089
F30LED	66.41	067
F50LED	83.04	067
F70LED	99.67	067
I418SD	274.89	033
I418SDPC	365.28	033
I418SDVT	395.68	033
LF218ED*	113.60	047
LF218SD*	170.51	047
LF236ED	156.31	047
LF236SD	213.17	047
LF280ED	184.74	047
LF280SD	241.47	047
P236SD	200.35	051
P258SD	223.54	051
S100EXLSD	762.07	085
S100EXSD	721.01	085
S100UCSD	716.58	085
S150EXLSD	875.80	085
S150EXSD	841.70	085
S250EXLSD	1,039.00	085
S250EXSD	984.31	085
S30UCSD	580.09	085
S50EXLSD	659.72	085
S50EXSD	625.58	085
S50UCSD	614.22	085
S70EXLSD	693.82	085
S70EXSD	659.72	085
S70UCSD	642.15	085

ACCESSORY

Order Code	Price €	Page
1232	47.30	033
3504	13.33	054
3505	11.00	054
3506	13.71	054
3507	15.18	054
3905	98.18	054
8063	100.00	057,061
10404	5.84	033
12657	37.22	070,089
12658	47.23	074,089
12659	71.43	070,074,080
12661	40.31	070,074
12662	51.38	070,074
12663	17.13	063,070,074,080
12664	35.72	070,074
12665	36.05	070
12666	51.50	080
15018	34.25	057
15019	32.11	057,061
15039	42.46	014,020,023,029,033,038
15040	42.46	057,061
20080	33.11	051
20081	46.10	051
20087	88.18	051
20088	18.89	051
20089	28.10	023
20097	28.10	029
20100	28.10	029
20101	28.10	023
20104SA	*	014.017
20107	70.79	057
20113	79.27	057
20122	23.53	057
20123	13.18	061
20125	13.18	061
20126	20.55	047
20127	9.14	047
20128	12.98	038
20129	57.58	038
20133	23.29	047
20134	15.00	047
20135	90.67	047
20136	116.41	047
20137	129.51	047
20138	44.77	047
20139	17.91	047

Order Code	Price	Page
20140	12.31	047
20141	12.31	047
20142	12.31	047
20144	22.39	048
20145	22.39	048
20146	34.69	048
20147	34.69	048
26721	141.50	014.017
40190	20.00	020
40191	21.00	020
40610	17.89	045
40611	145.00	042
40612	14.73	045
40613	20.00	045
40614	19.98	045
40615	29.46	045
40616	36.36	045
40617	13.64	045
40618	12.62	045
40900	32.45	083
40901	32.45	083
40902	28.12	083
40903	28.12	083
40904	43.26	083
40905	43.26	083
40906	43.26	083
40907	43.26	083
40908	21.63	083
40909	23.79	083
40930	65.91	077
40931	70.98	077
40932	65.91	077
40933	162.23	077
70033	13.30	020,023,029
70048	12.60	029

SYSTEMS

Order Code	Price €	Page
15022	75.91	011
15024	62.83	010
15034	56.62	010
15039	42.46	010
20104	61.66	011
20108	61.66	011
20109	562.59	009
21100	67.50	010
21102	1,400.00	009

EMERGENCY INVERTER

Order Code	Price €	Page (emergency side)
19355L	134.20	095
19358	78.51	095
19359	101.27	095
19367	91.35	095
19368	207.52	095
19371	118.66	095
19375	67.16	107
19376	55.97	099.097
19390	163.23	099
19391	147.69	099

Resistance of materials to various

Beghelli Spa guarantees the safety and performance of its luminaires when used in normal environmental conditions or in the temperature range for which they have been designed. In the case of extreme environmental conditions and/or in the presence of potentially aggressive chemicals, the assessment of the luminaire to be installed must take into account the chemical compatibility of the individual materials of which it is made, as indicated in each individual luminaire sheet.

CHEMICAL COMPONENT	THERMOPLASTICS			
	METACRYLATE (PMMA)	POLYCARBONATE (PC)	NYLON (PC)	PVC (PA)
ACETONE	✗	✓	✓	✓
20% ARSENIC ACID	✓	✓	-	✓
10% CITRIC ACID	✓	✓	✓	✓
20% CITRIC ACID	✓	✓	✓	✓
10% ACETIC ACID	✓	✓	✗	✓
HYDROCHLORIC ACID	✓	✓	✗	✓
20% HYDROCHLORIC ACID	✓	✓	✗	✓
CHROMIUM ACID	✓	✓	✓	✓
FORMIC ACID UP TO 30%.	✓	✓	✓	✓
20% NITRIC ACID	✓	✓	✗	✓
SULPHURIC ACID UP TO 30%.	✓	✓	✗	✓
ETHYL ALCOHOL	✗	✓	✓	✓
ISOPROPYL ALCOHOL	✓	✗	✓	-
ANILINE	✗	✓	✓	✗
10% AMMONIA	✓	✗	✓	✓
PETROL	✓	✓	✓	✓
BENZOL	✗	✗	✓	✗
ALCOHOLIC BEVERAGES	✓	✓	✓	✓
BROMINE	✗	✓	✗	✗
SEA CLIMATE	✓	✓	✓	✓
SEA WATER	✓	✓	✓	✓
WHITE LIME	✓	✓	✓	✓
DIESEL FUEL	✓	✓	✓	✓
LIQUID CHLORINE (VAPOURS)	✗	✗	-	✗
CHLOROFORM	✗	✗	✓	✗
CALCIUM CHLORIDE	✓	✓	✓	✓
FERRIC CHLORIDE	✓	✓	✓	✓
ESANE	✓	✗	✓	✓
ETHER	✗	✗	✗	✗
PETROLEUM ETHER (BENZENE)	✓	✗	✓	✓
ETHYLENE	✓	✗	✓	✗
FENOLS	✗	✗	✗	-
GLYCERIN	✓	✓	✓	✓
HYDROCARBONS	✓	✗	✓	-
METHANOL	✗	✗	✓	✓
MINERAL OILS	✓	✗	✓	✓
VEGETABLE OILS	✓	✓	✓	✓
SILICONE OIL	✓	✓	✓	✓
DIESEL OIL-NAFTA	✓	✓	✓	✓
EDIBLE OIL AND FATS	✓	✓	✓	✓
OZONE	✓	✓	✗	✓
POTASSIUM PERMANGANATE	✓	✓	✗	✓
SODA	✓	✓	✓	✓
CAUSTIC SODA	-	✓	✗	✓
ZINC SULPHATE	✓	✓	✓	✓
ALUMINIUM SULPHATE	✓	✓	✓	✓
COPPER SULPHATE	✓	✓	✗	✓
CARBON TETRACHLORIDE	✗	✗	✗	✗
TOLUENE	✗	✗	✓	✗
TRICHLOROETHYLENE	✗	✗	✓	✗

chemicals

✔ Resistant ⚠ Relatively resistant ✘ Not resistant

CHEMICAL COMPONENT	STEEL			OTHER MATERIALS	
	STAINLESS STEEL (304)	PRE-GALVANISED PAINTED	PAINTED	ALUMINIUM	GLASS
ACETONE	✔	✔	⚠	✔	✔
20% ARSENIC ACID	-	-	⚠	✘	⚠
10% CITRIC ACID	✔	⚠	⚠	⚠	✔
20% CITRIC ACID	✔	✘	✘	⚠	-
10% ACETIC ACID	✔	✘	✘	✘	✔
HYDROCHLORIC ACID	✘	✘	✘	✘	-
20% HYDROCHLORIC ACID	✘	✘	✘	✘	⚠
CHROMIUM ACID	✔	⚠	✘	⚠	⚠
FORMIC ACID UP TO 30%.	✔	✘	✘	✘	✘
20% NITRIC ACID	✔	✘	✘	✘	⚠
SULPHURIC ACID UP TO 30%.	✘	✘	✘	✘	⚠
ETHYL ALCOHOL	✔	✔	✔	✔	✔
ISOPROPYL ALCOHOL	✔	✔	✘	✔	✔
ANILINE	✔	✔	⚠	✘	✔
10% AMMONIA	✔	✔	✔	✔	⚠
PETROL	✔	✔	✔	✔	✔
BENZOL	✔	✔	✔	✔	✔
ALCOHOLIC BEVERAGES	✔	✔	✔	✔	✔
BROMINE	✘	✘	✘	✘	✔
SEA CLIMATE	✔	✘	✘	✘	✔
SEA WATER	✔	✘	✘	⚠	⚠
WHITE LIME	✔	✔	✔	⚠	-
DIESEL FUEL	✔	✔	✔	✔	-
LIQUID CHLORINE (VAPOURS)	✘	-	✘	✘	✘
CHLOROFORM	✔	✔	✔	✔	✔
CALCIUM CHLORIDE	⚠	✘	⚠	✘	✔
FERRIC CHLORIDE	✘	✘	✘	✘	-
ESANE	✔	✔	✔	✔	✔
ETHER	✔	✔	⚠	✔	✔
PETROLEUM ETHER (BENZENE)	✔	✔	✔	✔	-
ETHYLENE	✔	✘	✘	⚠	✔
FENOLS	✔	✘	✘	✔	✔
GLYCERIN	✔	✔	✔	✔	✔
HYDROCARBONS	✔	✔	✔	✔	✔
METHANOL	✔	✔	✔	⚠	✔
MINERAL OILS	✔	✔	✔	✔	✔
VEGETABLE OILS	✔	✔	✔	✔	✔
SILICONE OIL	✔	✔	✔	✔	✔
DIESEL OIL-NAFTA	✔	✔	✔	⚠	✔
EDIBLE OIL AND FATS	✔	⚠	⚠	✔	✔
OZONE	✔	⚠	✘	✔	✔
POTASSIUM PERMANGANATE	✔	✔	✔	✔	✔
SODA	✔	✔	✔	✘	✘
CAUSTIC SODA	✔	⚠	-	✘	✘
ZINC SULPHATE	⚠	✘	✘	✘	-
ALUMINIUM SULPHATE	⚠	✘	✘	✔	✔
COPPER SULPHATE	⚠	✘	✘	✘	✔
CARBON TETRACHLORIDE	⚠	✘	✘	✘	✔
TOLUENE	✔	✔	✔	✔	✔
TRICHLOROETHYLENE	⚠	⚠	⚠	✘	-

General terms and conditions of sale

1. ORDERS - FINALISATION OF AGREEMENTS

Product purchase orders shall be formulated in writing. Order placement is deemed irrevocable. All collaboration programs, orders, work orders and agreements are considered finalised by the written or verbal confirmation of the Seller or, however, as soon as the invoicing and/or delivery of the ordered products is initiated.

2. VARIANTS AND MODIFICATIONS

After order finalisation, any modification or addition to the content and conditions of the order shall be valid and will become effective only after the Buyer receives a confirmation variant from the Seller. The text of the Seller's confirmation or confirmation variant shall in all cases prevail over any other document. If the Buyer does not intend to accept the conditions that differ from his/her order, he/she must inform the Seller within 20 (twenty) days from the date of confirmation; otherwise, the confirmation variant will be considered fully accepted.

3. METHOD OF ACCEPTANCE

The Seller shall not be held liable for any unaccepted orders or for any failed or delayed delivery of the products part thereof. Acceptance and execution of the order are specifically subject to the availability of the products ordered as well as the absence of circumstances that may affect the availability of the same and the timeliness of their delivery.

4. TERMS OF DELIVERY

The delivery terms communicated by the Seller are purely indicative. Delivery terms expressed in days are normally counted in working days. Any changes to the delivery terms requested by the Buyer must be first accepted in writing by the Seller. Any delay in deliveries, as well as any interruption and/or total or partial suspension of supplies, even if not due to force majeure and/or accidental circumstances, will not entitle the Buyer to compensation for damages and/or to any other kind of indemnity or interest, except for the sole right to cancel the order, provided that the Seller is notified in advance, with at least thirty days before the day of receipt of the registered letter with acknowledgement of receipt sent by the Buyer.

5. FORCE MAJEURE

By way of example, but not limited to, the following are considered cases of force majeure: strikes, lockouts, riots, labour conflicts, fires, natural disasters, impossibility of supplying products, interruptions or difficulties in transport, delays of shipment, lack of raw materials, government acts, authority measures, contractual non-fulfilment by suppliers and, in general, any unforeseeable event that is outside the reasonable control of the Seller. In all such cases, as well as in the event of any accidental circumstances, the Seller reserves the right to suspend and/or delay the delivery of the products and even cancel the orders, even if already confirmed; this will not entitle the Buyer to compensation for damages and/or to any other kind of indemnity, including those for direct, indirect and consequential loss.

6. DELIVERY - TRANSPORT

The goods always travel at the risk and danger of the Buyer, even if delivered carriage paid and/or using a vehicle of the Seller; therefore, the Seller will not accept disputes for any product breakage and/or tampering. The delivery of the products is intended to be carried out at the Seller's headquarters in Monteveglio - Valsamoggia (Bologna) or at third party warehouses with which the Seller has entered into special agreements ("Ex works" condition - Incoterms 2010). Transport costs are borne by the Buyer. The Seller does not accept returns.

7. COMPLAINTS - PRODUCT REPLACEMENT

Any requests for replacement and complaints shall be handled by applying the safeguards provided by the applicable legislation in relation to the specific type of customer, professional operator or consumer. Upon product receipt, the Buyer must check its condition, the quantity delivered and its compliance with the delivery note. Any complaints concerning product quality, quantity or type shall be submitted in writing within 8 (eight) days from the date of receipt of the goods. After this period, without prejudice to the warranty conditions provided for the individual products, no claim can be made regarding the material and quality of the goods, or their condition in general. The Buyer may not, under any circumstances, return the products without the prior written authorisation of the Seller, nor delay and/or suspend the payment of invoices in whole or in part, not even in the case of complaints. If, in the opinion of the Seller, the claim is justified and has been filed within the warranty terms stated in the booklets accompanying the individual products, the obligation of the latter is limited only to the replacement of the nonconforming product in accordance with the delivery terms established for the first delivery. It is, therefore, excluded any right of the Buyer to cancel the order or to obtain any compensation for expenses and/or damages. The right to replace the contested product shall lapse if the product is not diligently stored, kept at the disposal of the Seller, and returned immediately to the place determined by the Seller.

8. APPLICATION OF WARRANTY

The warranty applies only to faults and/or defects in the conformity of the product in relation to the terms and conditions indicated in the declared and/or agreed technical specifications or in case of premature breakage of one of its parts. The validity period of the aforementioned warranty is at least 24 months from the date of purchase, which can be proved by presenting a valid tax document. Luminaires with extended warranties are marked in catalogues or instruction sheets with the number of years of total warranty in conjunction with the letter G (e.g., 5G marking for products with a 5-year warranty). As a general rule, the following extensions apply: emergency luminaires equipped with Lithium Iron batteries (LiFe) and centralised emergency lighting systems benefit from a 5-year warranty, those equipped with Lithium Titanate batteries (LTO) benefit from a 10-year warranty (for all parts, including batteries); EcoDriver or Dimmable luminaires benefit from a 3-year warranty, SmartDriver luminaires benefit from a 5-year warranty (for all parts, including sources). The warranty does not apply in case of tampering, to defects caused by accidental damage of any kind, including during transport and installation, in case of improper use or use in disagreement with the product specifications, in case of negligence in use and maintenance, errors in installation or connection, and installation performed by unqualified personnel or without respecting the state-of-the-art standards. Unless otherwise required by applicable law, the warranty is limited only to the replacement/repair of nonconforming products or parts, according to the delivery terms of the first delivery. All work performed under warranty by the Seller shall be subject to observance of the payment conditions by the Buyer.

9. PRICES

The prices indicated in the Seller's price lists are not binding; therefore, the Seller reserves the right to modify them until the time of delivery of the products. All prices are exclusive of VAT and any other tax charges.

10. PAYMENTS

All payments shall be made, within the terms and in the manner indicated by the Seller, to its headquarters in Monteveglio - Valsamoggia (Bologna) or to the appointed person authorised in writing by the Seller. In case of delay in payment, the defaulting buyer will be obliged to pay the Seller interests on late payment from the date of expiry of the contractual period until settlement, to the extent provided for in Legislative Decree 231/2002, apart from any compensation for any further damages incurred. Failure to comply with the payment terms by the Buyer will give the Seller the right to terminate the corresponding supply contract with immediate effect and to suspend the delivery of all products ordered without the need for any communication, with the consequent right of the Seller to demand the immediate payment of the entire credit as well as to claim compensation for the damages incurred. In case of non-fulfilment and/or worsening of the patrimonial conditions of the Buyer to a degree that may jeopardise the collection of the credit by the Seller, as well as in the event of prolonged delay in payments and/or high total debt exposure (also due to previous uncollected sales), the Seller reserves the right to apply the provisions of art. 1460 and 1461 CC, undertake appropriate precautionary actions and resort to any other form of self-protection permitted; it is further agreed that in such cases the Seller may suspend any and all supplies.

11. LIEN AGREEMENT

The products sold are subject to a lien agreement; therefore, the Seller will retain possession of the goods sold until their price is paid in full. The Buyer, therefore, undertakes to inform third parties of the existence and effectiveness of this Lien Agreement, as well as to safeguard the Seller's rights deriving from the same.

12. SAFEGUARDING – DISPUTES AND JURISDICTION

The invalidity or unenforceability of any of the clauses contained in these general conditions of sale shall not affect, or detract from the validity and enforceability of the other provisions; the Seller and the Buyer undertake to replace any clauses declared ineffective and/or null, or impracticable, with other provisions having similar effects. For any dispute or contestation relating to the interpretation, validity and execution of the order or, in any case, concerning the contracts to which these general conditions of sale apply shall be governed by the Italian Law. The Forum of Bologna shall have exclusive jurisdiction.

Product safety and European Directives

PRODUCT SAFETY AND EUROPEAN DIRECTIVES

Beghelli products are manufactured according to the state-of-the-art standards concerning safety and quality and will not affect, even when used under foreseeable overload conditions, the safety of persons, pets and property, on condition that they are correctly installed and used according to their intended purpose in the recommended environmental conditions and subject to proper maintenance by qualified personnel.

To the extent applicable, the products shall be manufactured in accordance with the requirements of Community Directives 2014/35/EU, 2014/30/EU, 2014/53/EU, 2014/30/EU, 2009/125/CE, 2001/65/CE.

The CE marking affixed to the product and/or packaging and/or any warnings of use accompanying the product attest to the conformity of the product with the aforementioned Directives. Beghelli has its own Technical Archive, available to the competent authorities for possible inspections, containing documentation demonstrating that the product has been examined to assess its compliance.

Products that do not fall within the scope of the above-mentioned EC Directives comply with the quality standards laid down by the regulations in force and by Directive 2001/95/CE ("General Product Safety Directive"), transposed by Legislative Decree No. 172/2004.

The data contained in this catalogue may be subject to change without notice.

The indications, dimensions, drawings and photos of the products and components are given for informational purposes only and may be modified without prior notice, as they do not constitute pre-contractual information. All products intended to be connected to the mains shall be installed in compliance with the installation standards in force in the country of use, observing the information contained in the Catalogue and/or the relevant instructions supplied with the product itself.

Environmental protection

WEEE DIRECTIVE 2012/19/EU

The quantities of waste from electrical and electronic equipment (WEEE) are rapidly increasing; most of the light sources are included in this category.

The main aim of the directive is to prevent WEEE from being discarded to landfills or incinerators at the end of their life, thereby causing further serious environmental impact.

Directive 2012/19/EU, therefore, sought to induce a control mechanism which provides for a controlled end-of-life management of the device by giving priority to its reuse or recycling. In addition, the legislative mechanism promotes design and production concepts that make it easier to dispose of the products in terms of both their disassembly and their materials.

All supply chain participants are invited to make their own contribution, some with regard to the economic aspects, some in terms of activity, so that the spirit of the directive is respected (and the environment is protected).

In Italy, the Directive has been transposed by Legislative Decree No. 49 of 14 March 2014.

THESE ARE THE MAIN OBLIGATIONS FORESEEN

The manufacturer (understood in a broad sense and, therefore, essentially as the person who affixes one's own brand on the goods and who imports them from third countries) is responsible for the costs of disposing of their products at the end of their life.

The consumer is required to guarantee an intelligent management of the product at the end of its life by sending it to a specially equipped site, a point of sale or by observing the instructions provided by the manufacturer.

Beghelli, always sensitive to environmental issues, is one of the founding members of the ECOLIGHT consortium.

Choosing products from companies that have joined voluntary consortia for the recovery and recycling of goods is the responsible and ecologically correct choice to protect the environment and our future.

Products falling under the scope of the WEEE Directive are identified by this symbol.



ROHS DIRECTIVE 2011/65/UE

In order to facilitate the recovery and recycling of electrical equipment and to prevent hazardous substances from accumulating into the environment, the European Community has enacted the ROHS Directive. Essentially, this Directive states that:

Without prejudice to Annex 3, the placing on the market of new electrical and electronic equipment falling within the categories identified in Annex 1 containing lead, mercury, cadmium, hexavalent chromium, polybrominated biphenyls (PBB) or polybrominated diphenyl ether (PBDE) in excess of the value indicated in Annex 2, shall be prohibited. In Italy, the Directive has been transposed by Legislative Decree No. 27 of 4 March 2014.

ECOLIGHT



Dealer
IMQ mark



Partner **DIALUX**

Associate: **ANIE**

Assil



The technical data and images in this catalogue are subject to continuous development and may change without notice. To check the latest technical update of the luminaires, please refer to the electronic catalogue on www.beghelli.com.

Digital catalogues of the various product ranges are also available on the website and can also be requested in hard copy from:
BEGHELLI S.p.A. - Commercial Division - Via Mozzeghine, 13/15 Valsamoggia Loc. Monteveglio - 40053 BO

© Copyright 06/2021

Beghelli

BEGHELLI S.p.A. Via Mozzeghine 13/15 - 40053 Valsamoggia loc. Monteveglio
Bologna - Italy - Tel. +39 051 9660411 - info@beghelli.it - www.beghelli.com

097 general terms and conditions of sale