



Emergency system



Arclightstudio

Esempi di applicazione della gamma E-TRACK con MODULINE M32 e illuminazione di emergenza in un centro commerciale.
Application example of E-TRACK with MODULINE M32 and emergency lighting in a mall hall.



Esempi di applicazione della gamma MIXED 48V track con MODULINE M32 e illuminazione di emergenza in un supermercato.
Application example of MIXED 48V track with MODULINE M32 and emergency lighting in a supermarket.

EMERGENCY TRACKS

A.A.G. Stucchi presenta la nuova famiglia di binari ed accessori **certificati** e usati per l'**illuminazione di emergenza**
A.A.G. Stucchi presents its new family of tracks and accessories **certified** to be used for **emergency lighting**.

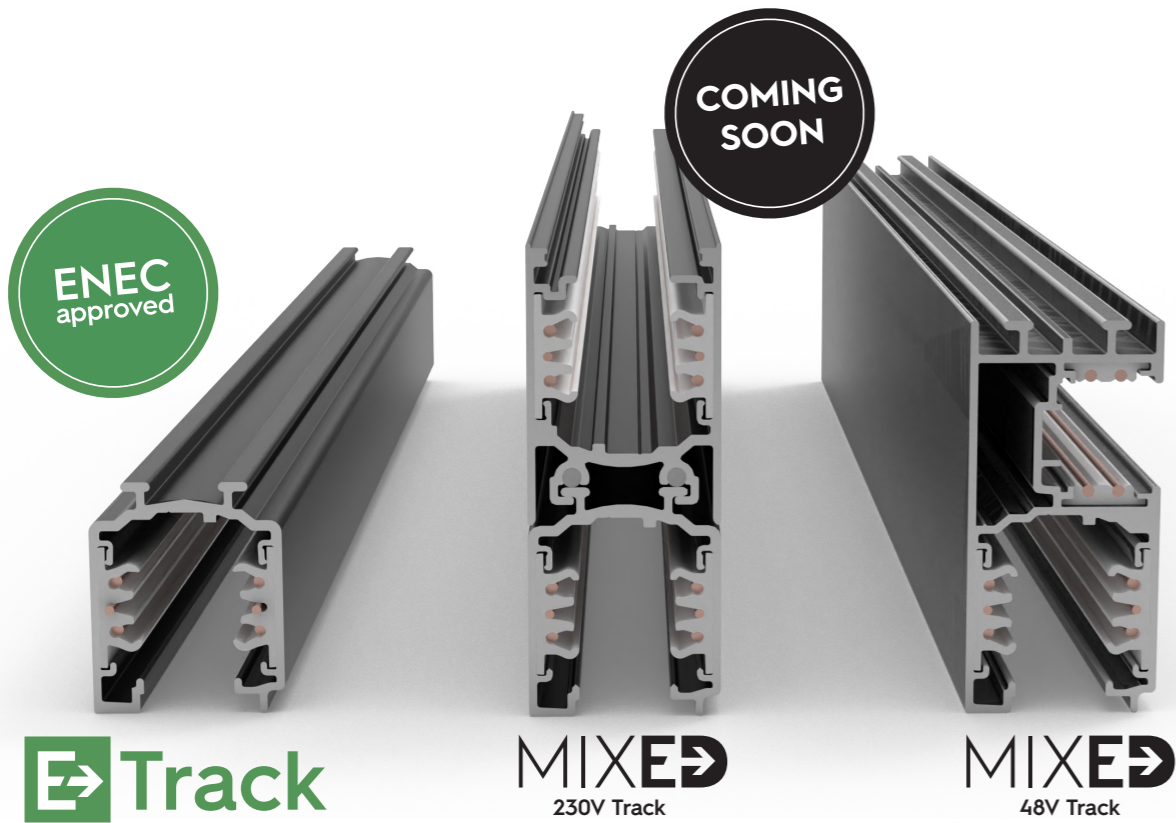

A.A.G. STUCCHI e din
A.A.G. STUCCHI and din



din è leader nello sviluppo e nella produzione di illuminazione di emergenza. Siamo orgogliosi della nostra collaborazione, che si conclude con una vasta gamma di apparecchi illuminanti dotati di adattatori A.A.G. Stucchi disponibili nel loro catalogo, pronti per essere utilizzati nel nostro sistema Mixed 48.

din is a leader in the development and production of emergency lighting. We are proud of our collaboration, which ends with a full range of luminaires with A.A.G. Stucchi adapters available in their catalogue, ready to be used into our Mixed 48 system.



STRING 2



BASIC 2 E-Sign



STRING SPOT



TUBE-264



CONCEPT 2

Esempi di applicazione di binari di emergenza con segnali di emergenza, illuminazione di emergenza e MODULINE opal.
Application example of emergency tracks with emergency signs, emergency lights and MODULINE opal.



Track
D+ D- 250V - 10A
Refer and use only with adapters as per installation instructions

Etichetta da posizionare su ogni giuntura del binario, contenuta in tutti i kit di alimentazione, connessione e tappo.
Label to be positioned at any track junction. Label is part of each end-feed, connection or end cap kit

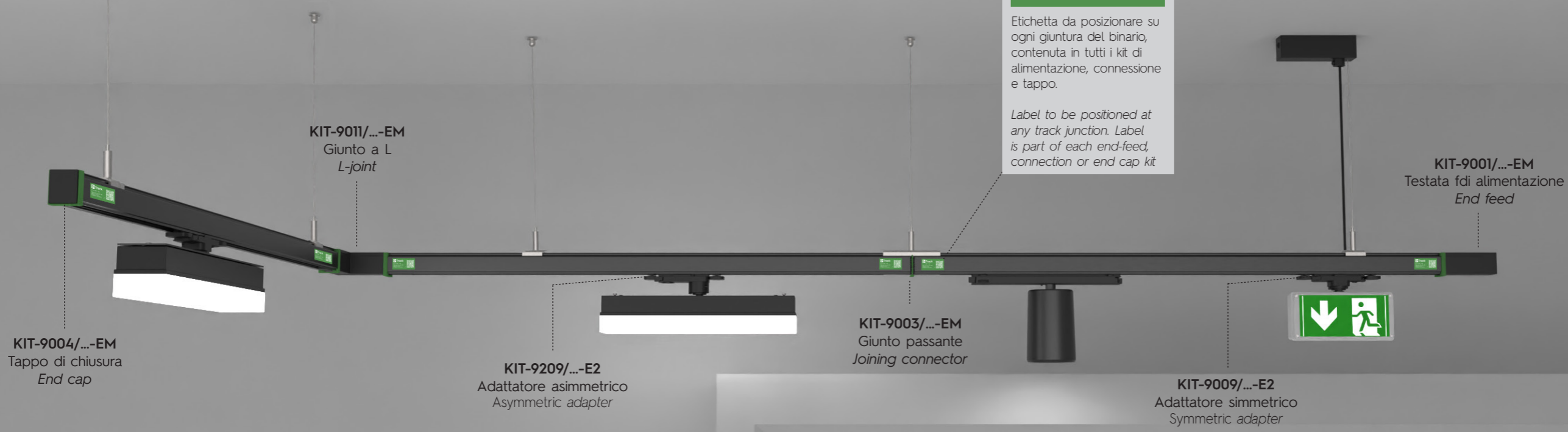

CODICI PRODOTTO
PRODUCT CODES

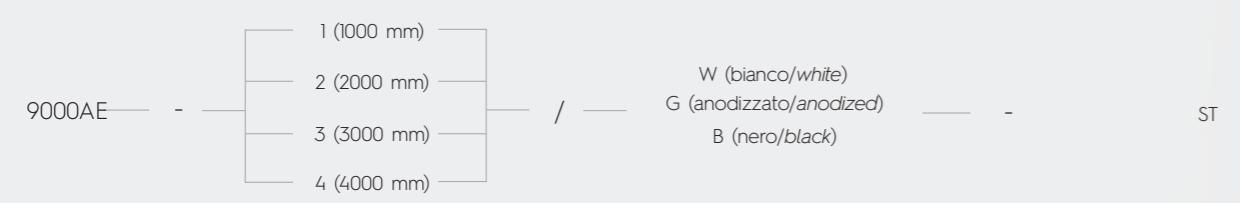

A.A.G. Stucchi presenta E-TRACK: la nuova gamma di prodotto certificata per utilizzo con **illuminazione di emergenza**.

Il binario trifase con 3 differenti linee a 440V/16A e un circuito 50V/1A, grazie all'utilizzo degli appositi kit e l'arretramento dei conduttori centrali, diventa idoneo per l'utilizzo 250V/10A che può essere utilizzata per l'alimentazione di una linea ordinaria di ricarica batteria per apparecchi di emergenza o combo con batteria a bordo.

La linea di emergenza può anche essere utilizzata come una normale quarta linea da 230V.

Il sistema è basato sull'esistente **ONETRACK ADVANCE** garantendo così la compatibilità con i suoi accessori senza la necessità di un nuovo stock.

A.A.G. Stucchi presents E-TRACK: the new product range certified to be used for **emergency lighting**.

The three phase track with three different 440V/16A lines and a 50V/1A circuit becomes suitable for 250V/10A use thanks to the use of special KITS and the recessed central conductors. The 250V/10A line is suitable as standard charging line for emergency standard or combo lighting fixtures with onboard battery.

The emergency line can also be used as a standard 230V 4th line.

The new system is based on the existing **ONETRACK ADVANCE** track thus providing compatibility with its accessories without the need of a new stock.

E-TRACK: ELEMENTI ED OPERAZIONI NECESSARIE PER AVERE UN SISTEMA CERTIFICATO.
 NECESSARY ELEMENTS AND OPERATIONS TO GUARANTEE A CERTIFIED SYSTEM.

Il sistema E-TRACK è **certificato per utilizzo con illuminazione di emergenza**, perchè il sistema sia conforme è necessario utilizzare gli appositi:
 - KIT di connessione e tappi con inserto di colore verde che impedisce fisicamente l'utilizzo di un binario diverso dal binario E-TRACK ed etichetta da applicare ad ogni giunzione del binario.
 - KIT adattatore con blocchi meccanici che impediscono la rimozione o lo spostamento degli apparecchi di emergenza dalla posizione predefinita.

The E-TRACK system **is certified for use with emergency lighting**. In order for the system to be compliant, it is necessary to use the following:
 - Connections and end caps kits with a green insert that physically prevents the use of a track other than E-TRACK, and labels to be applied to each track junction.
 - Adapter kit with mechanical locks that prevent the removal or movement of emergency lighting from the predetermined position.

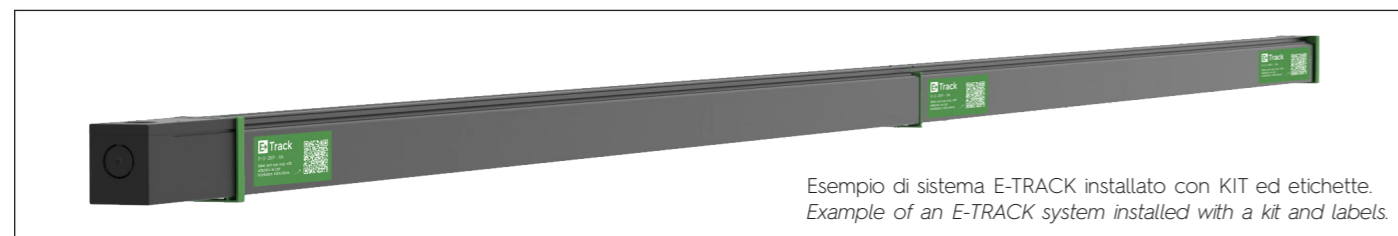

KIT ADATTATORI CON BLOCCHI MECCANICI
 ADAPTERS KIT WITH MECHANICAL LOCKS

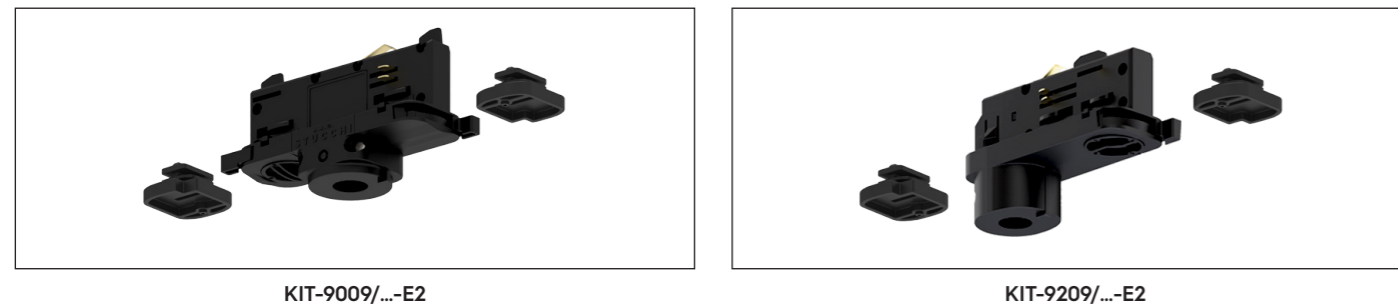

INSTALLAZIONE APPARECCHI CON KIT ADATTATORE E BLOCCHI MECCANICI
 FIXTURES INSTALLATION WITH ADAPTER ANCHE MECHANICAL LOCKS

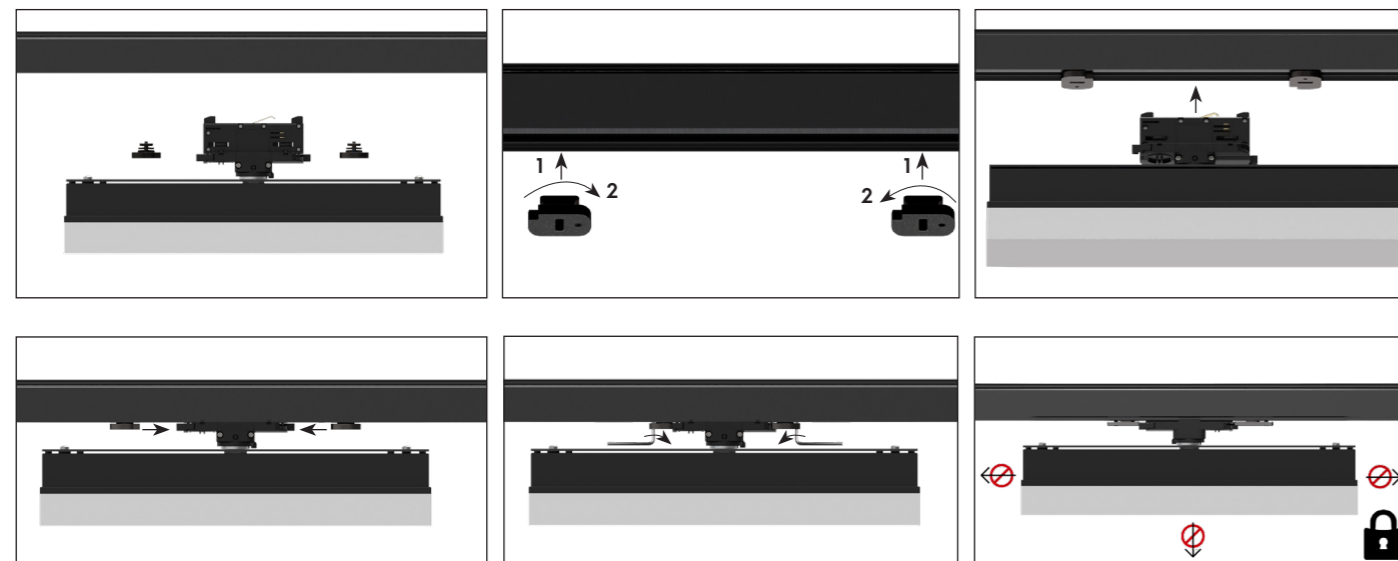

E-TRACK - LIGHTING SCENARIO

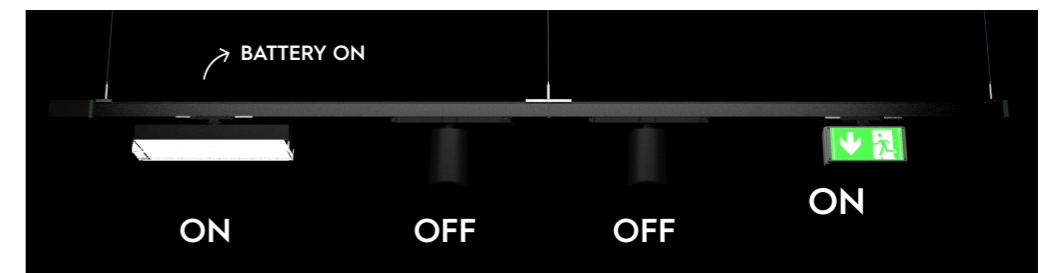
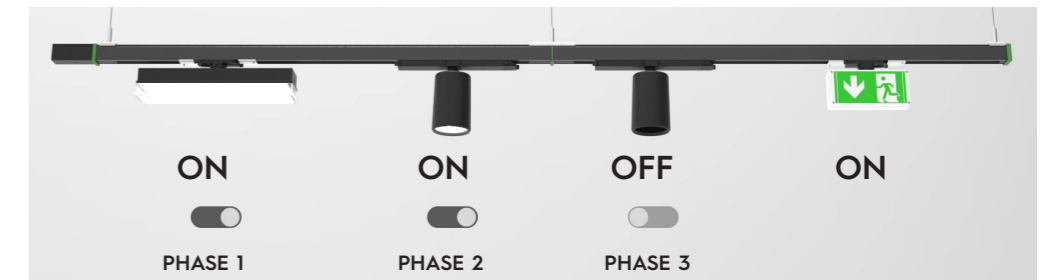
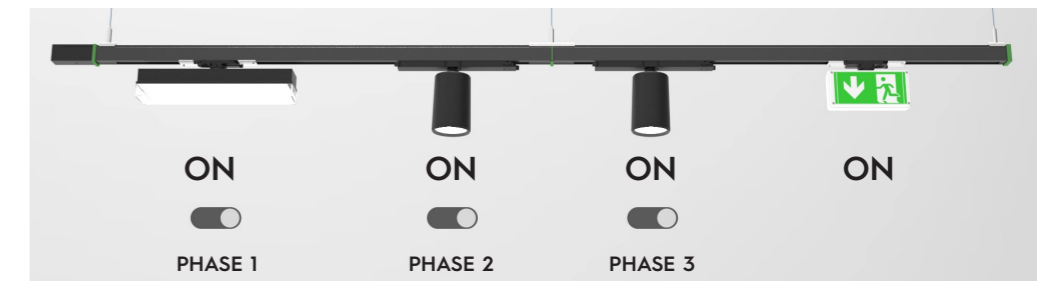
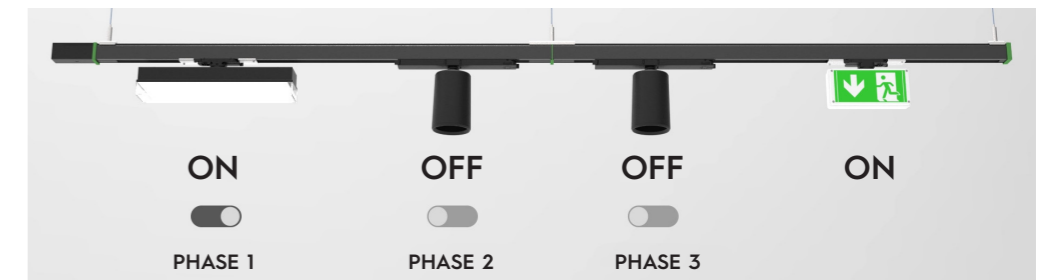
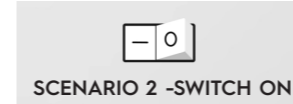
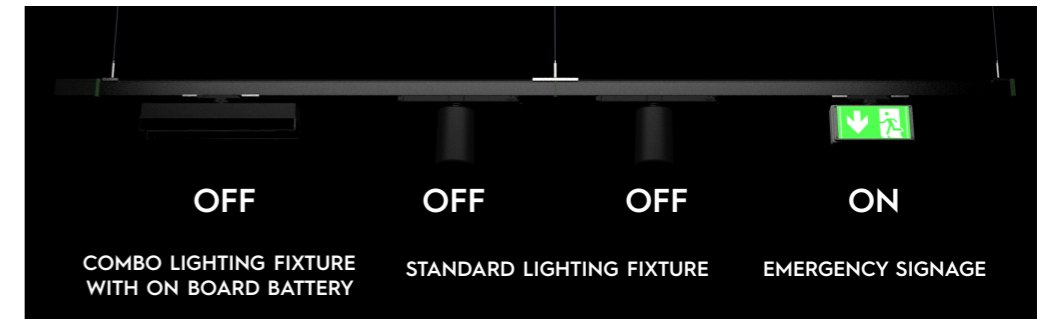

COME SCEGLIERE IL TUO BINARIO
HOW TO CHOOSE THE TRACK YOU NEED

E-TRACK

Colori disponibili: **B** nero RAL 9005 **G** grigio Anodizzato **W** bianco RAL 9010
Available colours: **B** black RAL 9005 **G** grey Anodized **W** white RAL 9010

BINARIO STANDARD / STANDARD TRACK

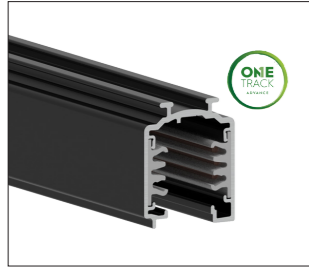

9000AE-.../B-ST
9000AE-.../G-ST
9000AE-.../W-ST

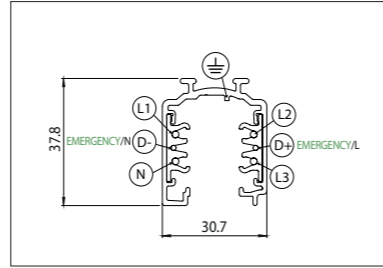

ACCESSORI PER BINARIO
TRACK ACCESSORIES

Colori disponibili: **B** nero **G** grigio **W** bianco **■** grezzo
Available colours: **B** black **G** grey **W** white **■** raw

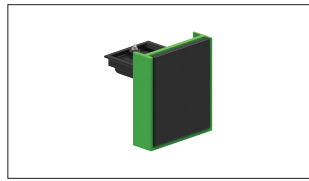

KIT-9004/...-EM

Tappe di chiusura con vite di blocco, inserto verde ed etichetta di certificazione
End cap with locking screw, green insert and certification label

W **G** **B**



S-9000/H...

Gancio di sospensione
Suspension hook

W **G** **B**

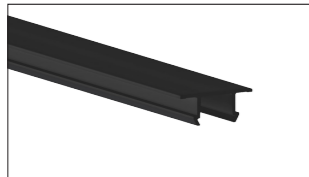

S-9000/GP...

Guaina di protezione supplementare
Additional cover strip

W **G** **B**



S-9000/TP-G

Tappe di protezione supplementare per asole binario
Additional closure cap for track slots

G

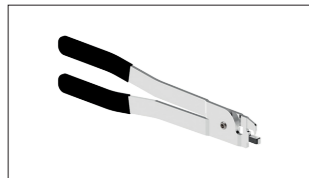

S-9000/T
S-9000/TA

Tronchesi per taglio conduttori del binario
Cutting tools for track conductors

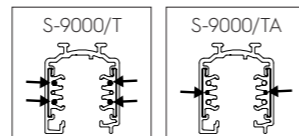

ACCESSORI PER IL FISSAGGIO DEL BINARIO
TRACK FIXING ACCESSORIES

BINARIO STANDARD
STANDARD TRACK

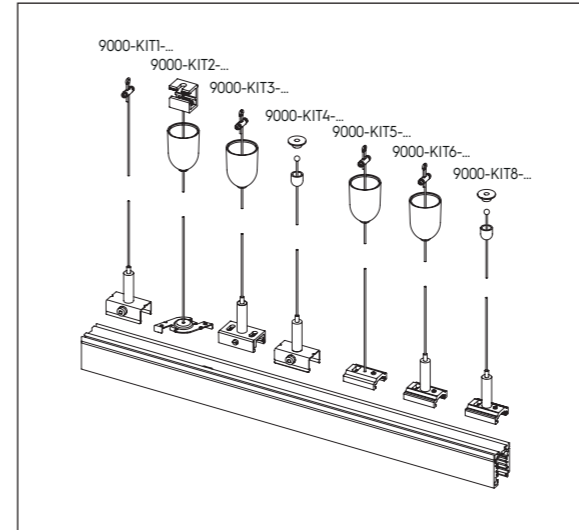

Kit completi per fissaggio a sospensione
Complete suspension kit

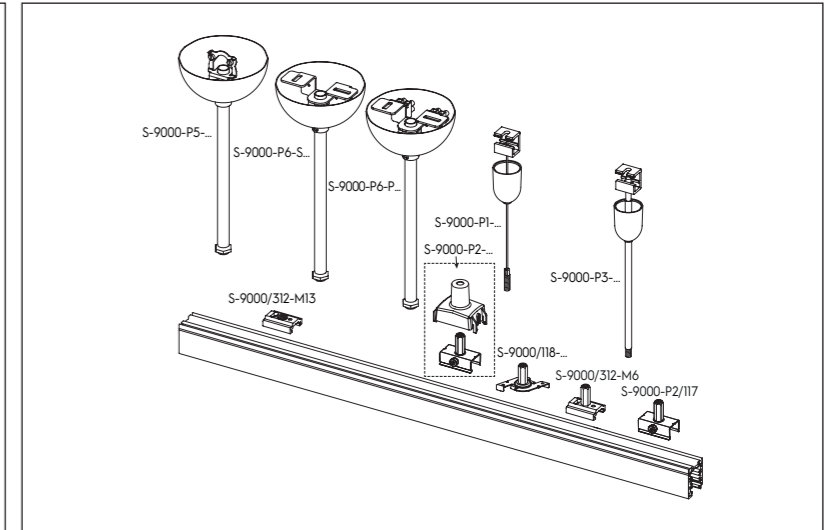

Set per fissaggio a sospensione
Suspension sets

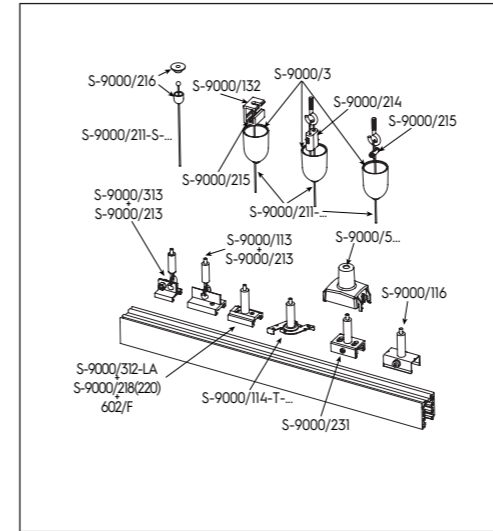

Accessori per sospensione con regolazione a binario
Suspension accessories with track adjustment

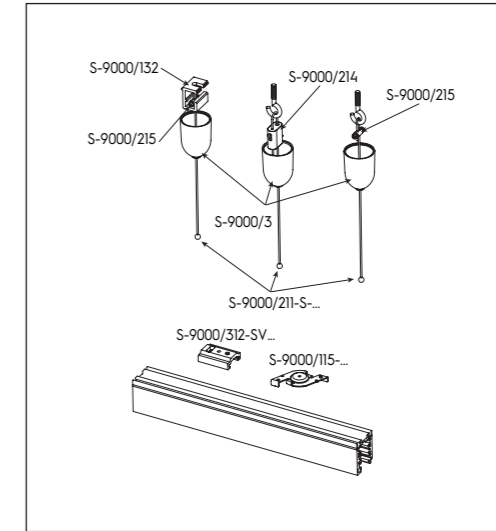

Accessori per sospensione con regolazione a plafone
Suspension accessories with ceiling adjustment

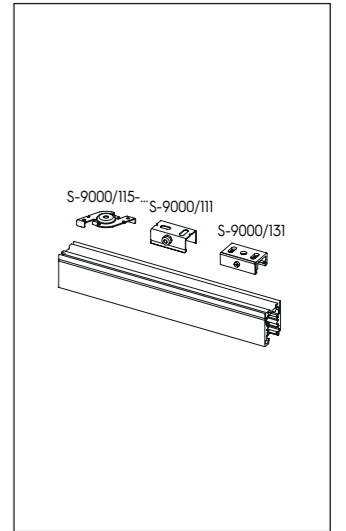

Accessori per fissaggio a plafone
Ceiling fixing accessories

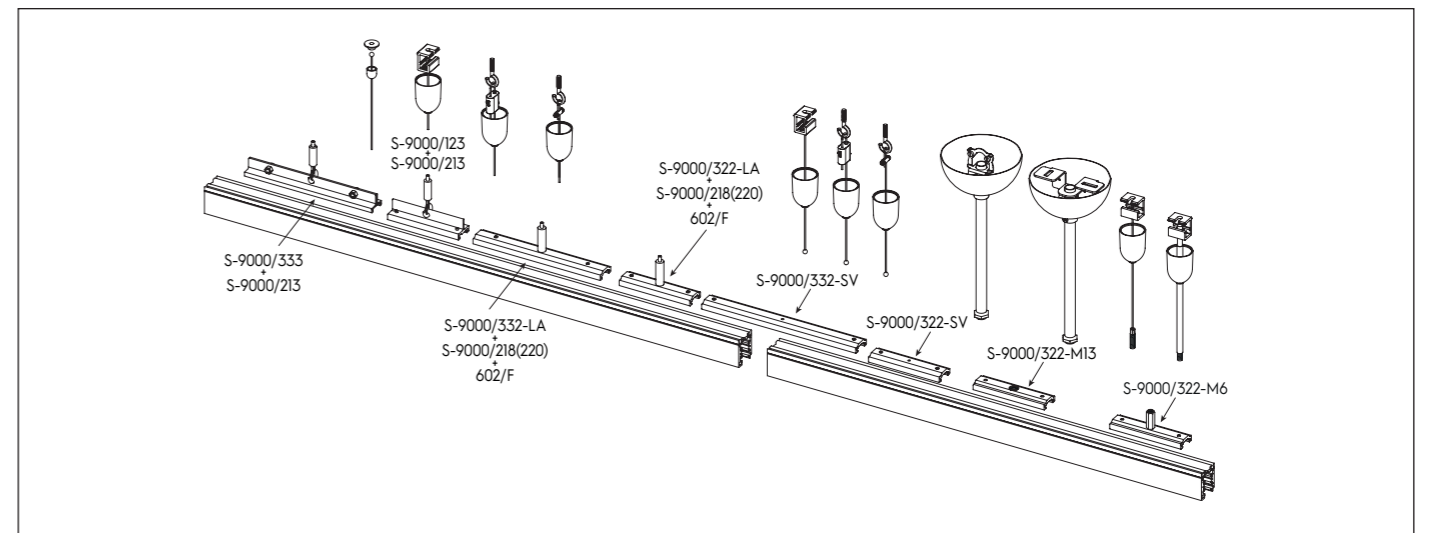

Accessori per giunzioni in fila continua
Accessories for "in row" use junctions

KIT COMPLETI PER IL FISSAGGIO A SOSPENSIONE
COMPLETE SUSPENSION KITS

Colori disponibili:
Available colours:

W bianco white	RAL 9010	B nero black	RAL 9005
G grigio grey	RAL 7035	■ grezzo raw	

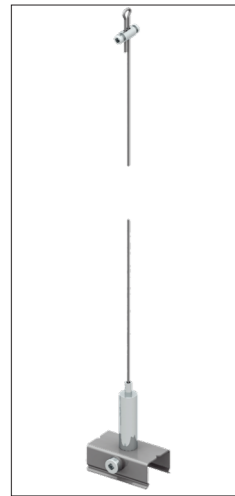

9000-KIT1-1.5
9000-KIT1-3
9000-KIT1-5

Composto da:
· tenditore a vite
· filo in acciaio Ø 1.5mm (L=1500/3000/5000mm)
· clip con tenditore automatico

Composed by:
· screw gripper
· steel cable Ø 1.5mm (L=1500/3000/5000mm)
· clamp with automatic gripper



9000-KIT2-1.5-...
9000-KIT2-3-...
9000-KIT2-5-...

Composto da:
· staffa per fissaggio a soffitto
· tenditore a vite
· rosone plastico
· filo in acciaio Ø 1.5mm (L=1500/3000/5000mm) con estremità sferica
· clip per fissaggio rapido

Includes:
· ceiling bracket
· screw gripper
· plastic cup
· steel cable Ø 1.5mm (L=1500/3000/5000mm) with spherical end
· fast fixing clamp

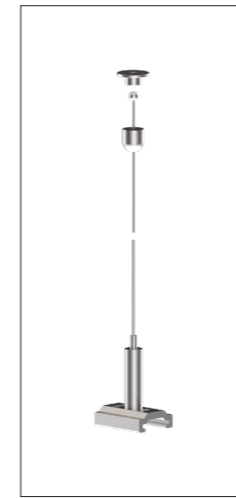

9000-KIT8-1,5 **9000-KIT8-1,5-...**
9000-KIT8-3 **9000-KIT8-3-...**
9000-KIT8-5 **9000-KIT8-5-...**

Composto da:
· rosone metallico sferico con foro
· filo in acciaio Ø 1.5mm (L=1500/3000/5000mm) con estremità sferica
· staffa con tenditore automatico

Includes:
· round head ceiling attachment
· steel cable Ø 1.5mm (L=1500/3000/5000mm) with spherical end
· bracket with automatic gripper



SET PER FISSAGGIO A SOSPENSIONE
SUSPENSION SETS

Colori disponibili:
Available colours:

W bianco white	RAL 9010	B nero black	RAL 9005
G grigio grey	RAL 7035	■ grezzo raw	



9000-KIT3-1.5-...
9000-KIT3-3-...
9000-KIT3-5-...

Composto da:
· tenditore a vite
· rosone plastico
· filo in acciaio Ø 1.5mm (L=1500/3000/5000mm)
· staffa con tenditore automatico

Includes:
· screw gripper
· plastic cup
· steel cable Ø 1.5mm (L=1500/3000/5000mm)
· bracket with automatic gripper

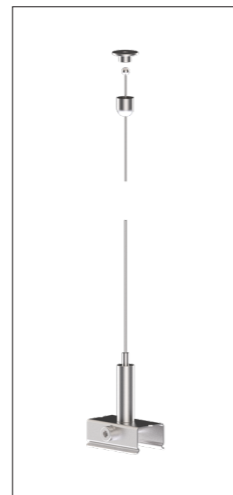

9000-KIT4-1.5
9000-KIT4-3
9000-KIT4-5

Composto da:
· rosone metallico sferico con foro
· filo in acciaio Ø 1.5mm (L=1500/3000/5000mm) con estremità sferica
· clip con tenditore automatico

Includes:
· round head ceiling attachment
· steel cable Ø 1.5mm (L=1500/3000/5000mm) with spherical end
· clamp with automatic gripper



S-9000-P1-1.5-...; S-9000-P1-3-...;
S-9000-P1-5-...

Composto da:
· staffa per fissaggio a soffitto
· tenditore a vite
· rosone plastico
· filo in acciaio Ø 1.5mm (L=1500/3000/5000mm) con terminale M6

Includes:
· ceiling bracket
· screw gripper
· plastic cup
· steel cable Ø 1.5mm (L=1500/3000/5000mm) with M6 threaded end



S-9000-P2-...

Composto da:
· clip con tenditore M6
· copertura plastica

Includes:
· clamp with M6 thread gripper
· plastic cover

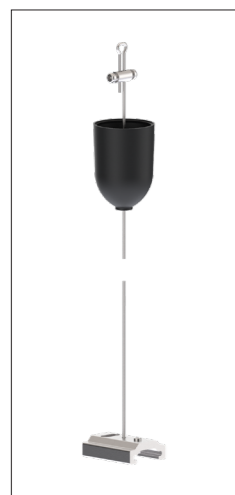

9000-KIT5-1.5-...
9000-KIT5-3-...
9000-KIT5-5-...

Composto da:
· tenditore a vite
· rosone plastico
· filo in acciaio Ø 1.5mm (L=1500/3000/5000mm) con estremità sferica
· staffa svasata

Includes:
· screw gripper
· plastic cup
· steel cable Ø 1.5mm (L=1500/3000/5000mm) with spherical end
· flaring bracket



9000-KIT6-1.5-...
9000-KIT6-3-...
9000-KIT6-5-...

Composto da:
· tenditore a vite
· rosone plastico
· filo in acciaio Ø 1,5mm (L=1,5/3/5m) con estremità sferica
· staffa con tenditore automatico

Composed by:
· screw gripper
· plastic cup
· steel cable Ø 1.5mm (L=1500/3000/5000mm) with spherical end
· bracket with automatic gripper



S-9000-P3-...

Composto da:
· staffa per fissaggio a soffitto
· dado M6
· rosone plastico
· barra filettata M6 (L=1000mm) con guaina di copertura

Includes:
· ceiling bracket
· M6 nut
· plastic round head
· M6 threaded bar (L=1000mm) with cover strip

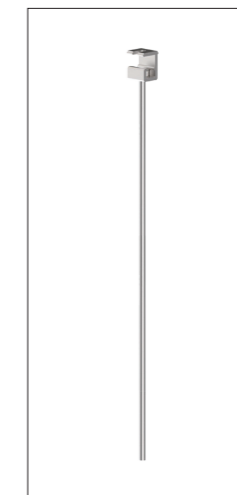

S-9000-P4

Composto da:
· staffa per fissaggio a soffitto
· dado M6
· barra filettata M6 (L=1000mm)

Includes:
· ceiling bracket
· M6 nut
· M6 threaded bar (L=1000mm)





S-9000-P5-B

- Composto da:
- gancio di fissaggio
 - tige metallica (L=2000mm)
 - rosone metallico

- Includes:
- ceiling hook
 - metal stem (L=2000mm)
 - metal cup

W B



S-9000-P6-P-...

- Composto da:
- staffa per fissaggio a soffitto
 - rosone metallico (ø 100mm)
 - tige filettata M13 (L= 1200mm) con controdado estremità sferica
 - 2 morsetti da 2P 400V-32A; T: 125°C; sez. 4mm² + morsetto di terra dedicato

- Includes:
- ceiling bracket
 - metallic cup (ø 100mm)
 - M13 threaded stem (L=1200mm) with counter-nut
 - 2 2P terminal blocks 400V-32A; T: 125°C; sect. 4mm² + dedicated earth terminal block

W B



S-9000-P6-S-...

- Composto da:
- staffa per fissaggio a soffitto
 - rosone metallico (ø 100mm)
 - tige filettata M13 (L= 1200mm) con controdado

- Includes:
- ceiling bracket
 - metallic cup (ø 100mm)
 - M13 threaded stem (L=1200mm) with counter-nut

W2 B

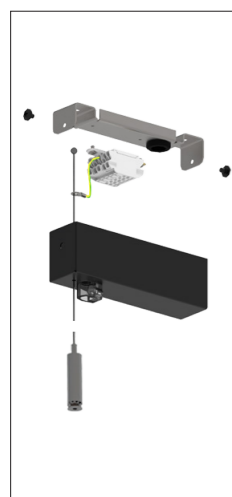

SET-RS/...-3

- Composto da:
- staffa per fissaggio a soffitto
 - 1 morsetto 2675/SP/43 con cavo di terra
 - filo in acciaio ø 1,5mm (L=3m) con estremità sferica
 - rosone metallico
 - tenditore automatico

- Includes:
- ceiling bracket
 - 1 terminal block 2675/SP/43 with earth wire
 - steel cable Ø 1.5mm (L=3m) with spherical end
 - metal cup
 - automatic lock

W2 BG Effetto gofrato
Embossed effect

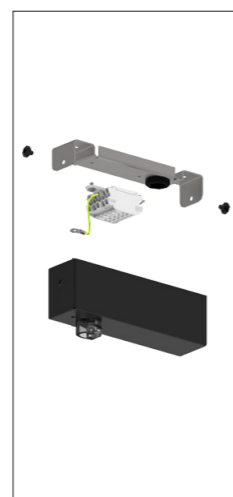

SET-RS/...

- Composto da:
- staffa per fissaggio a soffitto
 - 1 morsetto 2675/SP/43 con cavo di terra
 - rosone metallico

- Includes:
- ceiling bracket
 - 1 terminal block 2675/SP/43 with earth wire
 - metal cup

W2 BG Effetto gofrato
Embossed effect

ACCESSORI SINGOLI SINGLE ACCESSORIES

Colori disponibili:
Available colours:

W	bianco white	RAL 9010	W2	nero black	RAL 9016	
B	nero black	RAL 9005	G	grigio grey	RAL 7035	alluminio grezzo raw aluminium

ROSONI CUPS



S-9000/4-...

Rosone plastico per barra filettata M6
Plastic cup for steel M6 threaded bar

W G B



S-9000/6-...

Rosone metallico per barra filettata M13
Metal cup for steel M13 threaded bar

W B



S-9000/216

Rosone per fissaggio a soffitto
Round head ceiling attachment



STAFFE PER FISSAGGIO A PLAFONE CEILING FIXING BRACKET



S-9000/132

Staffa per fissaggio a plafone per sospensioni
Ceiling bracket for suspensions



GANCI PER FISSAGGIO A PLAFONE CEILING FIXING HOOK



S-9000/232

Gancio zincato con foro (Ø13mm) per fissaggio tige
Galvanized hook with fixing hole (Ø13mm) for stem



COPERTURE COVERS



S-9000/5-...

Copertura plastica per clip e staffe
Plastic cover for clamps and brackets

W G B

CLIP
CLAMPS

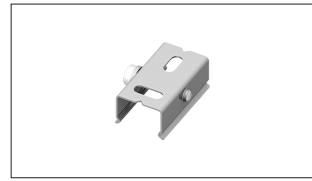

S-9000/111

Clip per fissaggio a soffitto
Ceiling clamp



S-9000/114-T-...

Clip in acciaio verniciato. Tenditore in acciaio nichelato.
Clamp in painted steel. Gripper in nickel-plated steel.



S-9000/115-...

Clip in acciaio verniciato
Clamp in painted steel

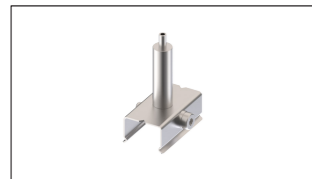

S-9000/116

Clip con tenditore automatico
Clamp with automatic gripper

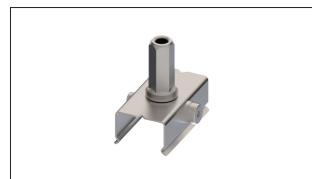

S-9000-P2/117

Clip con tenditore automatico
Clamp with automatic gripper



S-9000/118-...

Clip in acciaio verniciato. Tenditore M6 in acciaio nichelato
Clamp in painted steel. M6 threaded gripper in nickel-plated steel



S-9000/119-TB-...

Clip verniciata per fissaggio rapido del binario alla T-bar
Painted fast fixing clamp for fixing the track to the T-bar



STAFFE
BRACKETS



S-9000/131
S-9000/131-...

Staffa per fissaggio a plafone
Ceiling bracket

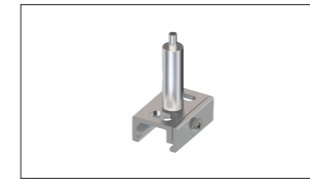

S-9000/231

Staffa con tenditore automatico
Bracket with automatic gripper

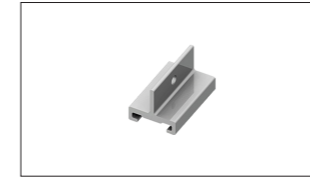

S-9000/113
S-9000/113-...

Staffa a T corta per sospensioni
Short T bracket for suspensions



S-9000/123
S-9000/123-...

Staffa a T lunga per sospensioni
Long T bracket for suspensions

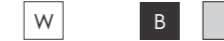

S-9000/313
S-9000/313-...

Staffa a T corta per sospensioni
Short T bracket for suspensions



S-9000/333
S-9000/333-...

Staffa a T lunga per sospensioni
Long T bracket for suspensions

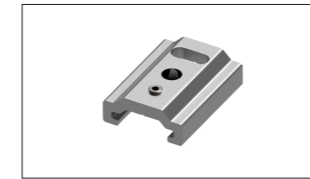

S-9000/312-LA
S-9000/312-LA-...

Staffa corta per sospensioni
Short bracket for suspensions



S-9000/322-LA
S-9000/322-LA-...

Staffa media per sospensioni
Medium bracket for suspensions



S-9000/332-LA
S-9000/332-LA-...

Staffa lunga per sospensioni
Long bracket for suspensions

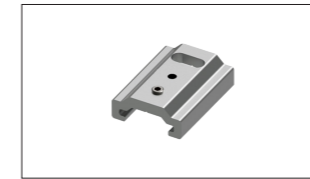

S-9000/312-SV
S-9000/312-SV-...

Staffa corta per sospensioni
Short bracket for suspensions





S-9000/322-SV
S-9000/322-SV-...

Staffa media per sospensioni
Medium bracket for suspensions

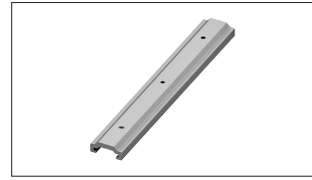

S-9000/332-SV
S-9000/332-SV-...

Staffa lunga per sospensioni
Long bracket for suspensions

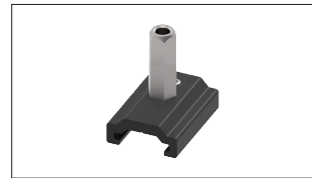

S-9000/312-M6-...

Staffa corta per sospensioni con tenditore M6
Short bracket with M6 gripper for suspensions



S-9000/322-M6-...

Staffa media per sospensioni con tenditore M6
Medium bracket with M6 gripper for suspensions



S-9000/312-M13-...

Staffa corta filettata M13 per sospensioni
Short M13 threaded bracket for suspensions



S-9000/322-M13-...

Staffa media filettata M13 per sospensioni
Medium M13 threaded bracket for suspensions



CAVI
CABLES



S-9000/211-...

Filo in acciaio ø1,5mm (...=L 1500/3000/5000mm)
Steel cable ø 1,5mm (...=L 1500/3000/5000mm)



S-9000/211-S-...

Filo in acciaio con terminale a sfera ø1,5mm (...=L 1500/3000/5000m)
Steel cable with spherical end ø 1,5mm (...=L 1500/3000/5000m)



TIGE
STEM



S-9000-1,2/604-...

Tige in ferro verniciato con dado e filetto M13X1 (L=1200mm)
Painted metal stem with M13X1 end + nut (L=1200mm)



TENDITORI
GRIPPERS



S-9000/213

Tenditore automatico ad uncino
Automatic gripper with lock



S-9000/214

Tenditore automatico
Automatic lock



S-9000/215

Tenditore a vite
Screw gripper



S-9000/218

Tenditore automatico M5 con foro laterale (da usare con vite 602/F fornita separatamente)
Automatic M5 threaded gripper with side hole (to be used with 602/F screw supplied separately)



602/F

Vite per il bloccaggio del tenditore sulle staffe LA
Set screw for gripper on the LA brackets



ADATTATORI ADAPTERS

Gli adattatori E-TRACK hanno un selettore di fase che permette di **mantenere la selezione effettuata** anche se l'adattatore viene spostato e/o reinserito nel binario. Questo permette inoltre di effettuare la selezione di fase **prima del montaggio** semplificando l'operazione.
Adattatori 9009... e 9209...: carico massimo **100N**. Momento di flessione massimo **5Nm**.
ATTENZIONE! per garantire la certificazione del sistema è necessario utilizzare sempre i blocchi meccanici degli adattatori contenuti nei kit.

E-TRACK adapters phase selector allows to **maintain the selected phase** even though the adapter is attached/detached or re-attached to the track. This gives also the possibility to select the phase **before the installation** making it easier.
9009... and 9209... adapters: maximum load **100N**. Maximum resistance to bending moment **5Nm**.
WARNING: to guarantee the system certification it is mandatory to use the mechanical locks of the adapters included in the kit.

Tipo di alimentazione di emergenza:
Power supply emergency type:

BAT

con batteria a bordo
with on board battery

Colori disponibili:
Available colours:

W

bianco
white

G

grigio
grey

B

nero
black

ADATTATORI SENZA DRIVER PER APPARECCHI D'EMERGENZA

DRIVERLESS ADAPTERS FOR EMERGENCY LINE-POWERED DEVICES

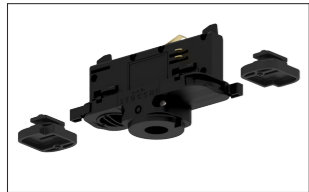

KIT-9009/...-E2

Adattatore simmetrico a 4 conduttori (1 fase (L3) + sistema di emergenza) con blocchi meccanici
Symmetric 4 conductors adapter (1 phase (L3) + emergency system) with mechanical locks

W G B

BAT



KIT-9209/...-E2

Adattatore asimmetrico a 4 conduttori (1 fase (L3) + sistema di emergenza) con blocchi meccanici
Asymmetric 4 conductors adapter (1 phase (L3) + emergency system) with mechanical locks

W G B

BAT

ADATTATORI SENZA DRIVER PER APPARECCHI ALIMENTATI DA QUARTA LINEA

DRIVERLESS ADAPTERS FOR FOURTH-LINE POWERED DEVICES



9009/...-E2

Adattatore simmetrico a 4 conduttori (1 fase (L3 - N) + quarta fase)
Symmetric 4 conductors adapter (1 phase (L3 - N) + fourth-line)

W G B

BAT



9209/...-E2

Adattatore asimmetrico a 4 conduttori (1 fase (L3 - N) + quarta fase (L-N))
Asymmetric 4 conductors adapter (1 phase (L3 - N) + fourth-line (L-N))

W G B

BAT

ADATTATORI SENZA DRIVER PER APPARECCHI STANDARD

ADAPTERS WITHOUT DRIVER FOR STANDARD LUMINAIRES



9009-4/...

Adattatore simmetrico a 4 conduttori (3 fasi)
Symmetric 4 conductors (3 phase) adapter

W G B



9009-4/...-HW

Adattatore simmetrico a 4 conduttori (3 fasi) con selettore di fase regolabile e leggibile anche di lato
Symmetric 4 conductors (3 phase) adapter with phase selector and indicator accessible and visible from side of adapter

W G B



9209-4/...

Adattatore asimmetrico a 4 conduttori (3 fasi)
Asymmetric 4 conductors (3 phase) adapter

W G B



9409-4/...

Adattatore compatto a 4 conduttori (3 fasi)
Compact 4 conductors (3 phase) adapter

W G B

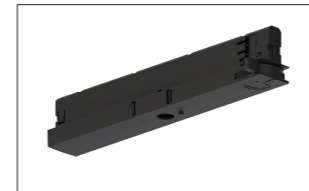

9409-4-DRI-SM/...-N

Adattatore a 4 conduttori (3 fasi) non brandizzato fornito smontato e senza driver
4 conductors (3 phase) adapter with no brand supplied disassembled and without driver

W G B

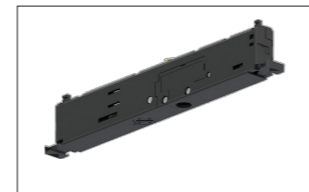

9999-4/...

Adattatore a scomparsa a 4 conduttori (3 fasi)
Concealed 4 conductors adapter (3 phase)

W B

ADATTATORI CON DRIVER INTEGRATO ER APPARECCHI STANDARD

ADAPTERS WITH INTEGRATED DRIVER FOR STANDARD LUMINAIRES

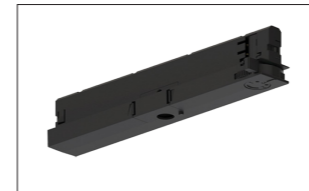

9409-4-DRI/...-S2-N-1

Adattatore a 4 conduttori (3 fasi) con driver integrato
4 conductors (3 phase) adapter with integrated driver

W G B

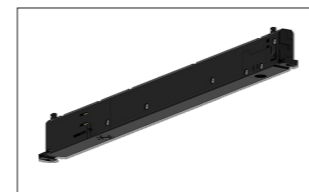

9999-4-DRI/...

Adattatore a scomparsa a 4 conduttori (3 fasi) con driver integrato
Concealed 4 conductors adapter (3 phase) with integrated driver

W B

ADATTATORI MECCANICI

MECHANICAL ADAPTERS



S-9000/M-...

Adattatore meccanico
Mechanical adapter

W G B

ACCESSORI DEGLI ADATTATORI
ADAPTER ACCESSORIES

Colori disponibili:
Available colours:



bianco
white



grigio
grey



nero
black



grezzo
raw



S-9009/BC-...

Bloccacavo esterno con vite in plastica
External cable lock with plastic screw

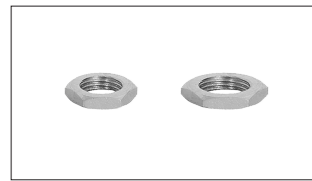

S-9009/D-M10
S-9009/D-M13

Dadi per raccordi (M10/M13)
Nuts for nipples (M10/M13)



S-9009/IP40-...

Carter IP40 per adattatori simmetrici 9009...
IP40 guard for 9009... symmetric adapters

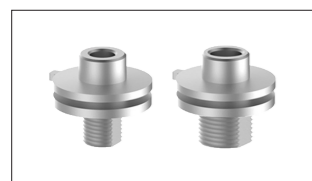

S-9009/M10
S-9009/M13

Raccordi (M10/M13) per adattatori 9009... e 9209...
Nipples (M10/M13) for adapters 9009... and 9209...

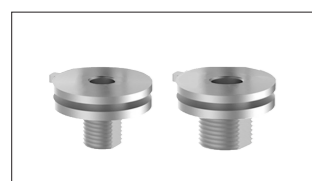

S-9009/M10-SC
S-9009/M13-SC

Raccordi (M10/M13) senza collare per adattatori 9009..., 9209... e 9409...
Nipples (M10/M13) without border for adapters 9009..., 9209... and 9409...



S-9009/M10-FI

Raccordo con filetto interno M10 per adattatori 9009..., 9209... e 9409...
Nipples with M10 internal thread for adapters 9009..., 9209... and 9409...



S-9009/T-INS

Inserto per cablaggio adattatori
Installation tool insert for adapter wiring



S-9009/T-HAN

Manico per inserto per cablaggio adattatori
Installation tool handle for adapters wiring



Immagine esemplificativa
Image for reference only



S-9009/10-...

Bloccacavo interno per adattatori simmetrici 9009...
Internal cable lock for 9009... symmetric adapters



S-9209/IP40-...

Carter IP40 per adattatori asimmetrici 9209...
IP40 guard for 9209... asymmetric adapters

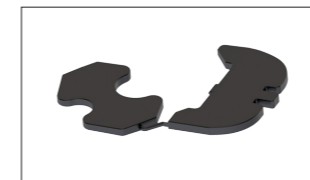

S-9209/20-...

Bloccacavo interno per adattatori asimmetrici 9209...
Internal cable lock for 9209... asymmetric adapters



S-9209/51

Anello con grano per il blocco della rotazione del raccordo. Per gli adattatori 9009... , 9209... e S-9000/M-... . Da usare solo con S-9009/M10 e S-9009/M13
Ring with locking grub screw to avoid rotation of the nipple. For adapter 9009... ,9209... e S-9000/M-... . To be used only with S-9009/M10 and S-9009/M13



CONNESSIONI ELETTROMECCANICHE ELECTRO-MECHANICAL CONNECTIONS

Tutte le connessioni sono realizzate in policarbonato autoestinguente con glow wire 960°C. Le connessioni sono disponibili in tutte le versioni necessarie per la composizione di un sistema di illuminazione complesso (posizionamento fase interno/esterno, dx/sx, come segnalato nel disegno del singolo articolo dall'apposita linea rossa).

Le connessioni del sistema E-TRACK prevedono l'utilizzo di un inserto di colore verde che impedisce fisicamente l'utilizzo di un binario diverso dal binario E-TRACK, garantendo così la sicurezza e la certificazione del sistema.

ATTENZIONE! Tutte le connessioni sono fornite con una etichetta che deve essere applicata ad ogni giunzione del binario per garantirne la certificazione. Gli inserti e le etichette verdi rendono inoltre immediatamente riconoscibili le installazioni realizzate con il sistema.

All connections are made of self-extinguishing polycarbonate, glow wire 960°C. Connections are available in all versions that allow the construction of a complete lighting application (internal/external, R/L phase placement as per red line in the singular drawing).

E-TRACK connections are provided with a green insert which physically prevent the use on any other track thus guaranteeing the system security and certification.

WARNING! connections are provided with a green label that must be placed on the track at any junction in order to guarantee certification.

Green inserts and labels are also a visual element which makes E-TRACK installations immediately recognizable.

Colori disponibili:
Available colours:

W bianco white G grigio grey B nero black

—→ polarità - vista dall'alto / polarity ridge - floor view

ALIMENTAZIONI FEEDS

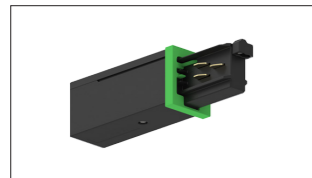

KIT-9001/...-EM
KIT-9002/...-EM

Testata di alimentazione
End Feed

W G B

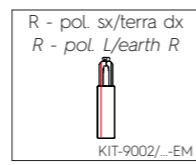
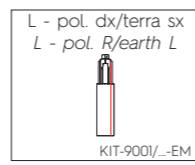

CONNESSIONI CONNECTIONS

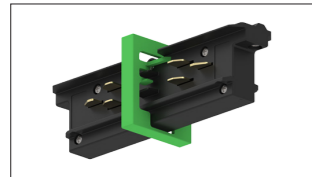

KIT-9003/...-EM

Giunto passante
Joining connector

W G B

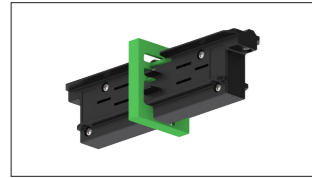

KIT-9003/...-M-EM

Connessione isolante
Insulating connection

W G B

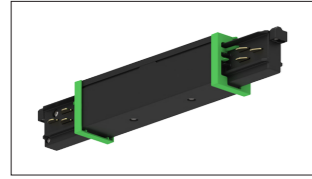

KIT-9010/...-EM

Giunto diretto
Middle joint

W G B

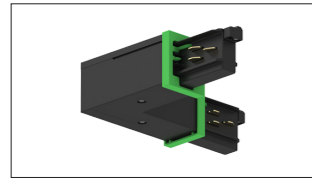

KIT-9011/...-EM
KIT-9012/...-EM

Giunto a L
L-joint

W G B

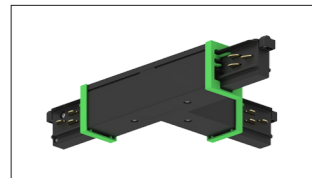
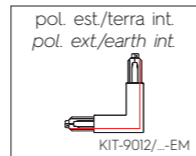
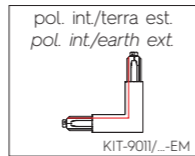

KIT-9013/...-EM
KIT-9014/...-EM
KIT-9015/...-EM
KIT-9016/...-EM

Giunto a T
T-joint

W G B

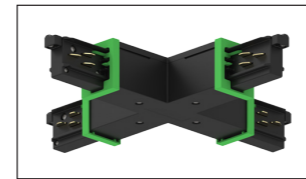
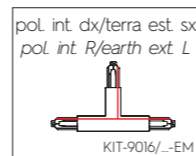
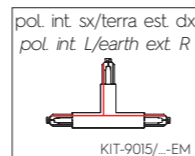
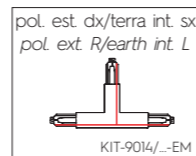
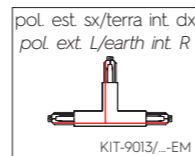

KIT-9017/...-EM

Giunto a X
X-joint

W G B

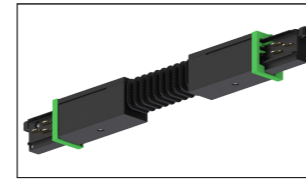

KIT-9018/...-EM

Giunto flessibile
Adjustable corner

W G B

ACCESSORI DELLE CONNESSIONI CONNECTION ACCESSORIES

Colori disponibili:
Available colours:

W bianco white B nero black



S-9001/115...

Guarnizione per testata di alimentazione.
Gasket for end feed.

W B

SAFETY FIRST!
A TRACK SYSTEM IS COMPLIANT TO THE RELEVANT STANDARDS
ONLY IF IT PROVIDES 2 DEDICATED CIRCUITS (C1 and C2)
FOR EMERGENCY LIGHTING*

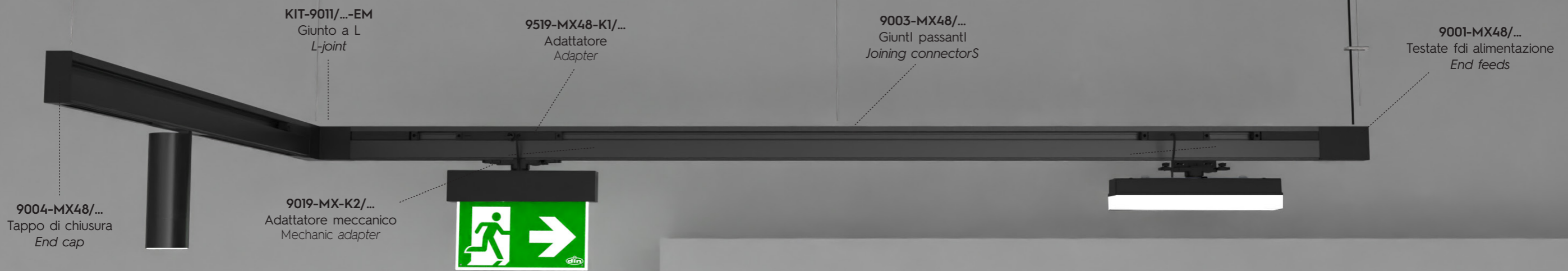

CODICI PRODOTTO
PRODUCT CODES

9000MX48	-	1 (1000 mm)	/	W (bianco/white)
		2 (2000 mm)		
		3 (3000 mm)		
		4 (4000 mm)		
				B (nero/black)

*ACCORDING TO INTERNATIONAL STANDARDS
IEC 60364-5-56:2018
VDE 0100-560:2022-10

A.A.G. Stucchi presenta MIXED 48VTRACK:

Questa gamma unisce le funzionalità di un binario **ONETRACK™ ADVANCE 230V** con DALI e un **binario a bassa tensione in Classe III**.
La parte superiore del binario può essere utilizzata per alimentare apparecchi per illuminazione di emergenza SELV.
Adatto per l'uso con apparecchi di emergenza controllati tramite CBS.

A.A.G. Stucchi presents MIXED 48V TRACK:

Combining the functionalities of **ONETRACK™ ADVANCE 230V** with DALI and a **Class III low-voltage track**.
The upper part of the track can be used to feed SELV emergency luminaires.
Suitable for use with emergency lighting fixtures controlled via CBS.

COME SCEGLIERE IL TUO BINARIO
HOW TO CHOOSE THE TRACK YOU NEED

MX48

BINARIO / TRACK

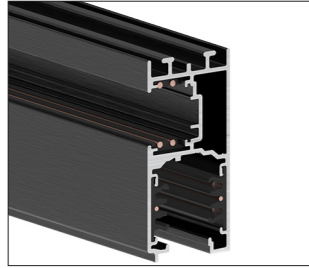

9000MX48-.../B
9000MX48-.../W

Colori disponibili:
Available colours: **B** nero black RAL 9005 **W** bianco white RAL 9010

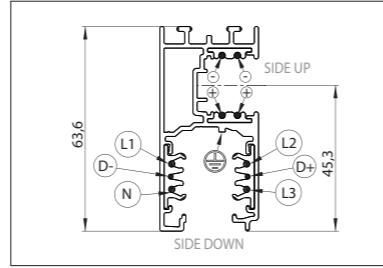

ACCESSORI PER BINARIO
TRACK ACCESSORIES



9004-MX48/B

Tappo di chiusura con vite di blocco
End cap with locking screw

W **G** **B**



S-9000/H-...

Gancio di sospensione
Suspension hook

W **G** **B**

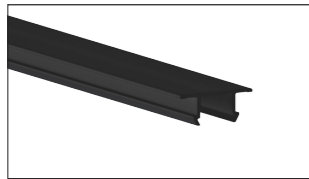

S-9000/GP-...

Guaina di protezione supplementare
Additional cover strip

W **G** **B**

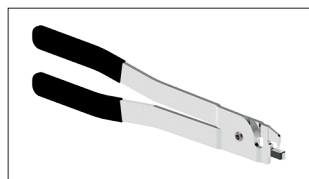

S-9000/T

Tronchesi per taglio conduttori del binario (SIDE DOWN)
Cutting tools for track conductors (SIDE DOWN)

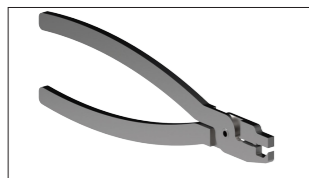

S-9600/T1

Pinza per bloccaggio pvc in caso di taglio binario (SIDE UP)
PVC locking clamp for track cut (SIDE UP)

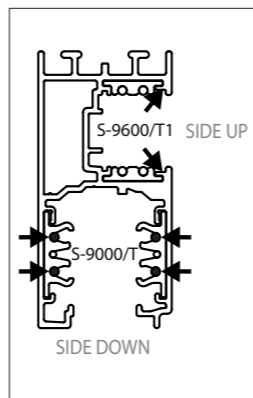

ACCESSORI PER IL FISSAGGIO DEL BINARIO
TRACK FIXING ACCESSORIES

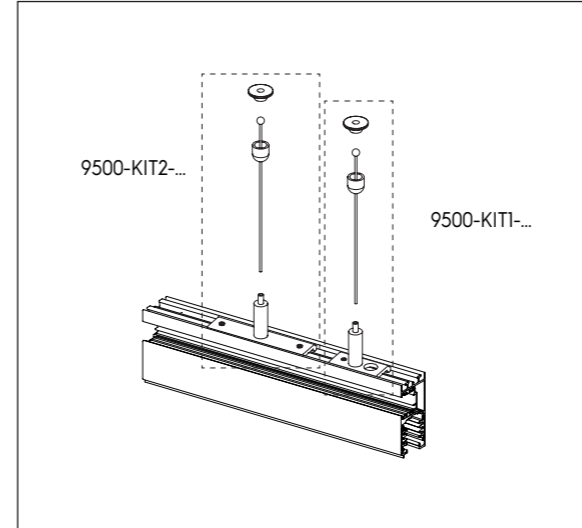

Kit completi per fissaggio a sospensione
Complete suspension kit

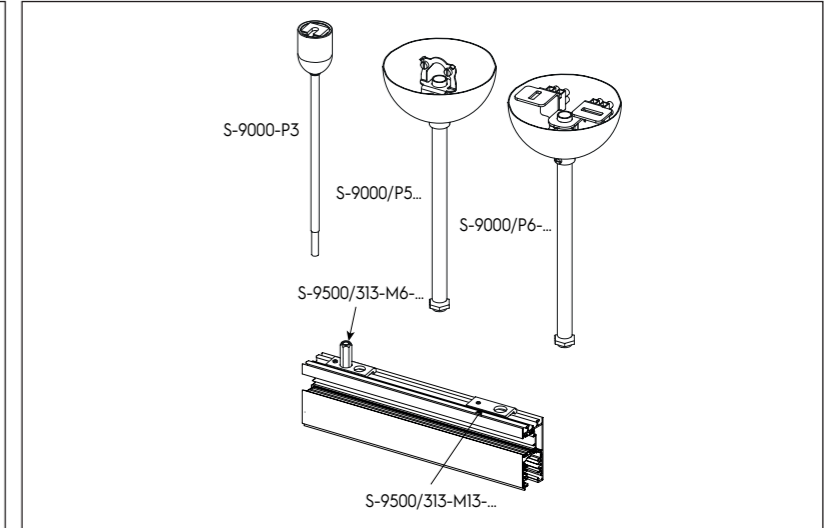

Set per fissaggio a sospensione
Suspension sets

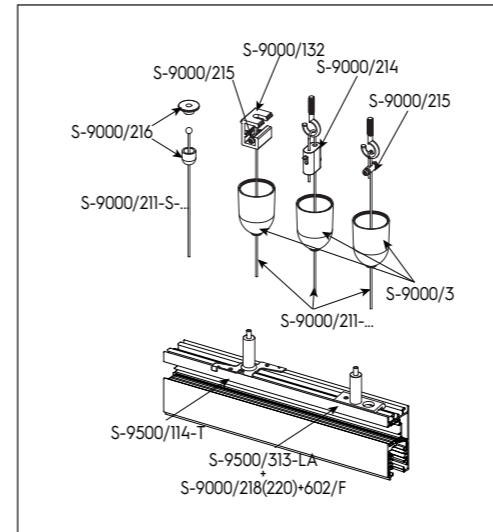

Accessori per sospensione con regolazione a binario
Suspension accessories with track adjustment

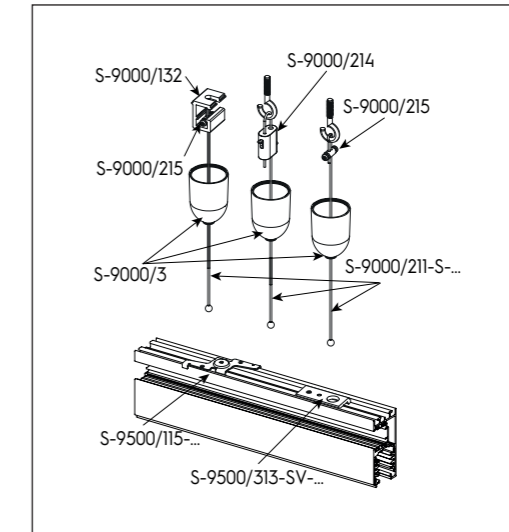

Accessori per sospensione con regolazione a plafone
Suspension accessories with ceiling adjustment

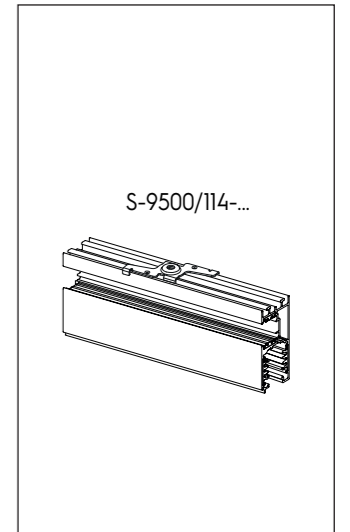

Accessori per fissaggio a plafone
Ceiling fixing accessories

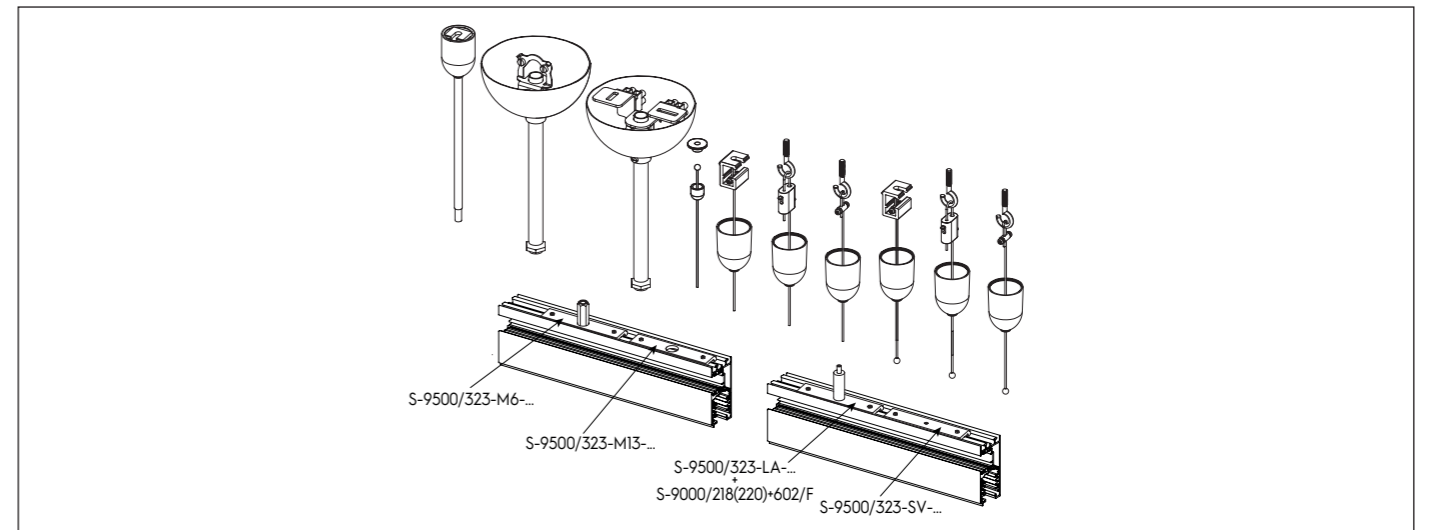

Accessori per giunzioni in fila continua
Accessories for "in row" use junctions

KIT COMPLETI PER IL FISSAGGIO A SOSPENSIONE
COMPLETE SUSPENSION KITS

Colori disponibili:
Available colours:

W bianco white	RAL 9010	B nero black	RAL 9005
G grigio grey	RAL 7035	■ grezzo raw	

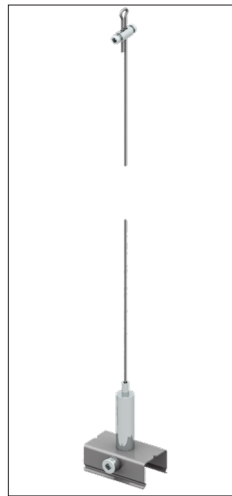

9000-KIT1-1.5
9000-KIT1-3
9000-KIT1-5

Composto da:
· tenditore a vite
· filo in acciaio Ø 1.5mm (L=1500/3000/5000mm)
· clip con tenditore automatico

Composed by:
· screw gripper
· steel cable Ø 1.5mm (L=1500/3000/5000mm)
· clamp with automatic gripper



9000-KIT2-1.5-...
9000-KIT2-3-...
9000-KIT2-5-...

Composto da:
· staffa per fissaggio a soffitto
· tenditore a vite
· rosone plastico
· filo in acciaio Ø 1.5mm(L=1500/3000/5000mm)
con estremità sferica
· clip per fissaggio rapido

Includes:
· ceiling bracket
· screw gripper
· plastic cup
· steel cable Ø 1.5mm (L=1500/3000/5000mm)
with spherical end
· fast fixing clamp



9000-KIT8-1,5 **9000-KIT8-1,5-...**
9000-KIT8-3 **9000-KIT8-3-...**
9000-KIT8-5 **9000-KIT8-5-...**

Composto da:
· rosone metallico sferico con foro
· filo in acciaio Ø 1.5mm (L=1500/3000/5000mm)
con estremità sferica
· staffa con tenditore automatico

Includes:
· round head ceiling attachment
· steel cable Ø 1.5mm (L=1500/3000/5000mm)
with spherical end
· bracket with automatic gripper



SET PER FISSAGGIO A SOSPENSIONE
SUSPENSION SETS

Colori disponibili:
Available colours:

W bianco white	RAL 9010	B nero black	RAL 9005
G grigio grey	RAL 7035	■ grezzo raw	



9000-KIT3-1.5-...
9000-KIT3-3-...
9000-KIT3-5-...

Composto da:
· tenditore a vite
· rosone plastico
· filo in acciaio Ø 1.5mm (L=1500/3000/5000mm)
· staffa con tenditore automatico

Includes:
· screw gripper
· plastic cup
· steel cable Ø 1.5mm (L=1500/3000/5000mm)
· bracket with automatic gripper

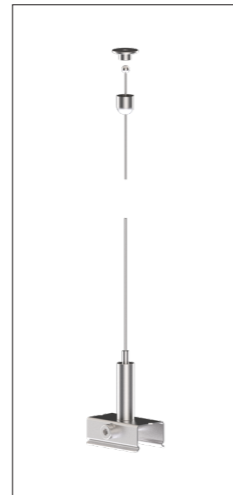

9000-KIT4-1.5
9000-KIT4-3
9000-KIT4-5

Composto da:
· rosone metallico sferico con foro
· filo in acciaio Ø 1.5mm (L=1500/3000/5000mm)
con estremità sferica
· clip con tenditore automatico

Includes:
· round head ceiling attachment
· steel cable Ø 1.5mm (L=1500/3000/5000mm)
with spherical end
· clamp with automatic gripper



S-9000-P1-1.5-...; S-9000-P1-3-...;
S-9000-P1-5-...

Composto da:
· staffa per fissaggio a soffitto
· tenditore a vite
· rosone plastico
· filo in acciaio Ø 1.5mm (L=1500/3000/5000mm)
con terminale M6

Includes:
· ceiling bracket
· screw gripper
· plastic cup
· steel cable Ø 1.5mm (L=1500/3000/5000mm)
with M6 threaded end



S-9000-P2-...

Composto da:
· clip con tenditore M6
· copertura plastica

Includes:
· clamp with M6 thread gripper
· plastic cover



9000-KIT5-1.5-...
9000-KIT5-3-...
9000-KIT5-5-...

Composto da:
· tenditore a vite
· rosone plastico
· filo in acciaio Ø 1.5mm (L=1500/3000/5000mm)
con estremità sferica
· staffa svasata

Includes:
· screw gripper
· plastic cup
· steel cable Ø 1.5mm (L=1500/3000/5000mm)
with spherical end
· flaring bracket



9000-KIT6-1.5-...
9000-KIT6-3-...
9000-KIT6-5-...

Composto da:
· tenditore a vite
· rosone plastico
· filo in acciaio Ø 1,5mm (L=1,5/3/5m)
con estremità sferica
· staffa con tenditore automatico

Composed by:
· screw gripper
· plastic cup
· steel cable Ø 1.5mm (L=1500/3000/5000mm)
with spherical end
· bracket with automatic gripper



S-9000-P3-...

Composto da:
· staffa per fissaggio a soffitto
· dado M6
· rosone plastico
· barra filettata M6 (L=1000mm)
con guaina di copertura

Includes:
· ceiling bracket
· M6 nut
· plastic round head
· M6 threaded bar (L=1000mm)
with cover strip

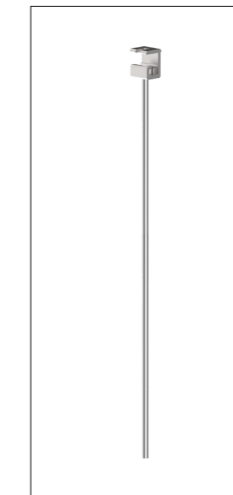

S-9000-P4

Composto da:
· staffa per fissaggio a soffitto
· dado M6
· barra filettata M6 (L=1000mm)

Includes:
· ceiling bracket
· M6 nut
· M6 threaded bar (L=1000mm)



**S-9000-P5-B**

- Composto da:
- gancio di fissaggio
 - tige metallica (L=2000mm)
 - rosone metallico

- Includes:
- ceiling hook
 - metal stem (L=2000mm)
 - metal cup

W B

SET PER FISSAGGIO A SOSPENSIONE CON ALIMENTAZIONE
SUSPENSION SETS WITH POWER SUPPLY**S-9000-P6-S-...**

- Composto da:
- staffa per fissaggio a soffitto
 - rosone metallico (ø 100mm)
 - tige filettata M13 (L= 1200mm) con controdado

- Includes:
- ceiling bracket
 - metallic cup (ø 100mm)
 - M13 threaded stem (L=1200mm) with counter-nut

W2 B

- Colori disponibili:
Available colours:
- W bianco white RAL 9010
 - W2 bianco effetto gofrato white embossed effect
 - B nero black RAL 9005

**S-9000-P6-P-...**

- Composto da:
- staffa per fissaggio a soffitto
 - rosone metallico (ø 100mm)
 - tige filettata M13 (L= 1200mm) con controdado estremità sferica
 - 2 morsetti da 2P 400V-32A; T: 125°C; sez. 4mm² + morsetto di terra dedicato

- Includes:
- ceiling bracket
 - metallic cup (ø 100mm)
 - M13 threaded stem (L=1200mm) with counter-nut
 - 2 2P terminal blocks 400V-32A; T: 125°C; sect. 4mm² + dedicated earth terminal block

W B

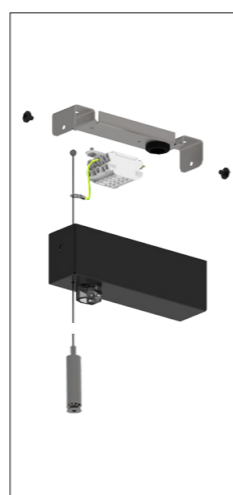
**SET-RS/...-3**

- Composto da:
- staffa per fissaggio a soffitto
 - 1 morsetto 2675/SP/43 con cavo di terra
 - filo in acciaio ø 1,5mm (L=3m) con estremità sferica
 - rosone metallico
 - tenditore automatico

- Includes:
- ceiling bracket
 - 1 terminal block 2675/SP/43 with earth wire
 - steel cable ø 1.5mm (L=3m) with spherical end
 - metal cup
 - automatic lock

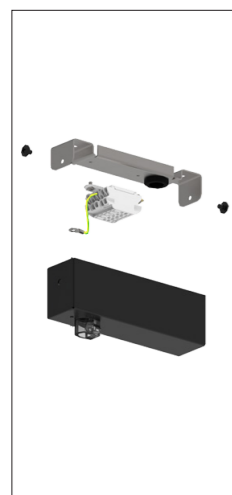
W2 BG Effetto gofrato
Embossed effect**SET-RS/...**

- Composto da:
- staffa per fissaggio a soffitto
 - 1 morsetto 2675/SP/43 con cavo di terra
 - rosone metallico

- Includes:
- ceiling bracket
 - 1 terminal block 2675/SP/43 with earth wire
 - metal cup

W2 BG Effetto gofrato
Embossed effect**ACCESSORI SINGOLI**
SINGLE ACCESSORIES

- Colori disponibili:
Available colours:
- W bianco white RAL 9010
 - W2 nero black RAL 9016
 - B nero black RAL 9005
 - G grigio grey RAL 7035
 - alluminio grezzo raw aluminium

ROSONI
CUPS

S-9000/4-...

Rosone plastico per barra filettata M6
Plastic cup for steel M6 threaded bar

W G B



S-9000/6-...

Rosone metallico per barra filettata M13
Metal cup for steel M13 threaded bar

W B



S-9000/216

Rosone per fissaggio a soffitto
Round head ceiling attachment**STAFFE PER FISSAGGIO A PLAFONE**
CEILING FIXING BRACKET

S-9000/132

Staffa per fissaggio a plafone per sospensioni
Ceiling bracket for suspensions**GANCI PER FISSAGGIO A PLAFONE**
CEILING FIXING HOOK

S-9000/232

Gancio zincato con foro (Ø13mm) per fissaggio tige
Galvanized hook with fixing hole (Ø13mm) for stem**COPERTURE**
COVERS

S-9000/5-...

Copertura plastica per clip e staffe
Plastic cover for clamps and brackets

W G B

CLIP
CLAMPS

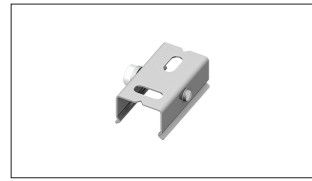

S-9000/111

Clip per fissaggio a soffitto
Ceiling clamp



S-9000/114-T-...

Clip in acciaio verniciato. Tenditore in acciaio nichelato.
Clamp in painted steel. Gripper in nickel-plated steel.



S-9000/115-...

Clip in acciaio verniciato
Clamp in painted steel

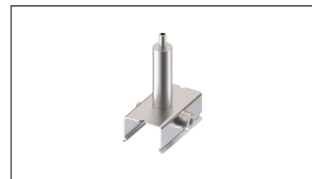

S-9000/116

Clip con tenditore automatico
Clamp with automatic gripper

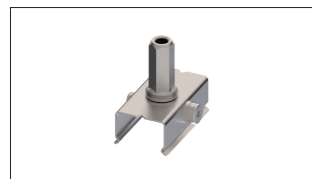

S-9000-P2/117

Clip con tenditore automatico
Clamp with automatic gripper



S-9000/118-...

Clip in acciaio verniciato. Tenditore M6 in acciaio nichelato
Clamp in painted steel. M6 threaded gripper in nickel-plated steel



S-9000/119-TB-...

Clip verniciata per fissaggio rapido del binario alla T-bar
Painted fast fixing clamp for fixing the track to the T-bar



STAFFE
BRACKETS



S-9000/131
S-9000/131-...

Staffa per fissaggio a plafone
Ceiling bracket

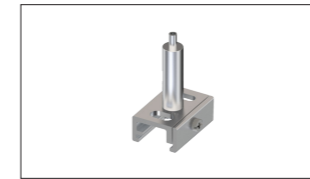

S-9000/231

Staffa con tenditore automatico
Bracket with automatic gripper

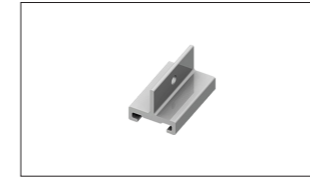

S-9000/113
S-9000/113-...

Staffa a T corta per sospensioni
Short T bracket for suspensions



S-9000/123
S-9000/123-...

Staffa a T lunga per sospensioni
Long T bracket for suspensions



S-9000/313
S-9000/313-...

Staffa a T corta per sospensioni
Short T bracket for suspensions

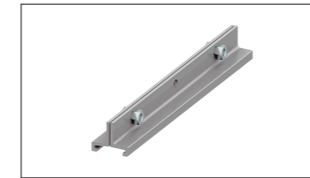

S-9000/333
S-9000/333-...

Staffa a T lunga per sospensioni
Long T bracket for suspensions

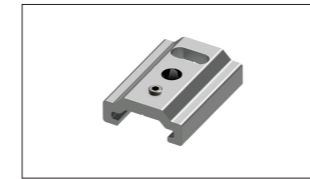

S-9000/312-LA
S-9000/312-LA-...

Staffa corta per sospensioni
Short bracket for suspensions



S-9000/322-LA
S-9000/322-LA-...

Staffa media per sospensioni
Medium bracket for suspensions



S-9000/332-LA
S-9000/332-LA-...

Staffa lunga per sospensioni
Long bracket for suspensions

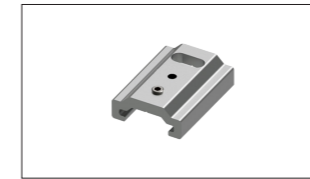

S-9000/312-SV
S-9000/312-SV-...

Staffa corta per sospensioni
Short bracket for suspensions





S-9000/322-SV
S-9000/322-SV-...

Staffa media per sospensioni
Medium bracket for suspensions



S-9000/332-SV
S-9000/332-SV-...

Staffa lunga per sospensioni
Long bracket for suspensions



S-9000/312-M6-...

Staffa corta per sospensioni con tenditore M6
Short bracket with M6 gripper for suspensions



S-9000/322-M6-...

Staffa media per sospensioni con tenditore M6
Medium bracket with M6 gripper for suspensions



S-9000/312-M13-...

Staffa corta filettata M13 per sospensioni
Short M13 threaded bracket for suspensions



S-9000/322-M13-...

Staffa media filettata M13 per sospensioni
Medium M13 threaded bracket for suspensions



CAVI
CABLES



S-9000/211-...

Filo in acciaio ø1,5mm (...=L 1500/3000/5000mm)
Steel cable ø 1,5mm (...=L 1500/3000/5000mm)



S-9000/211-S-...

Filo in acciaio con terminale a sfera ø 1,5mm (...=L 1500/3000/5000m)
Steel cable with spherical end ø 1,5mm (...=L 1500/3000/5000m)



TIGE
STEM



S-9000-1,2/604-...

Tige in ferro verniciato con dado e filetto M13X1 (L=1200mm)
Painted metal stem with M13X1 end + nut (L=1200mm)



TENDITORI
GRIPPERS



S-9000/213

Tenditore automatico ad uncino
Automatic gripper with lock



S-9000/214

Tenditore automatico
Automatic lock



S-9000/215

Tenditore a vite
Screw gripper



S-9000/218

Tenditore automatico M5 con foro laterale (da usare con vite 602/F fornita separatamente)
Automatic M5 threaded gripper with side hole (to be used with 602/F screw supplied separately)



S-9000/220

Tenditore automatico snodato M5 con foro laterale (da usare con vite 602/F fornita separatamente)
Automatic M5 jointed gripper with side hole (to be used with 602/F screw supplied separately)



602/F

Vite per il bloccaggio del tenditore sulle staffe LA
Set screw for gripper on the LA brackets



ADATTATORI
ADAPTERS

Tipo di alimentazione di emergenza:
Power supply emergency type:



con sistema batterie centralizzate
with centralized battery system

Colori disponibili:
Available colours:



bianco
white



grigio
grey



nero
black

ADATTATORI SENZA DRIVER PER APPARECCHI D'EMERGENZA (SIDE UP)
EMERGENCY FIXTURES ADAPTERS WITHOUT DRIVER (SIDE UP)

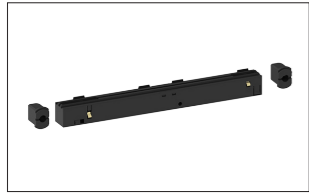

9519-MX48-K1/B
9519-MX48-K1/W

Kit adattatore simmetrico a 4 conduttori con blocchi di sicurezza
Symmetrical 4-conductor adapter with safety locks kit



ADATTATORI MECCANICI PER APPARECCHI D'EMERGENZA (SIDE DOWN)
EMERGENCY FIXTURES MECHANICAL ADAPTERS (SIDE DOWN)



9019-MX-K1/B
9019-MX-K1/W

Kit adattatore meccanico con blocchi meccanici di sicurezza
Mechanical adapter with mechanical safety locks kit

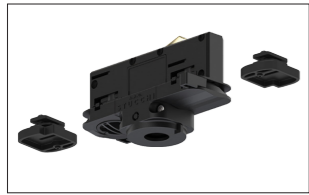

9019-MX-K2/B
9019-MX-K2/W

Kit adattatore simmetrico con leve di sgancio e blocchi meccanici di sicurezza
Symmetric adapter with release levers and mechanical safety locks kit



ADATTATORI SENZA DRIVER PER APPARECCHI STANDARD (SIDE DOWN)
ADAPTERS WITHOUT DRIVER FOR STANDARD LUMINAIRES (SIDE DOWN)



9009/...

Adattatore simmetrico a 6 conduttori (3 fasi + sistema di controllo)
Symmetric 6 conductors adapter (3 phase + control system)



9009-4/...

Adattatore simmetrico a 4 conduttori (3 fasi)
Symmetric 4 conductors (3 phase) adapter



9009/...-HW

Adattatore simmetrico a 6 conduttori (3 fasi + sistema di controllo) con selettore di fase regolabile e leggibile anche di lato
Symmetric 6 conductors adapter (3 phase + control system) with phase selector and indicator accessible and visible from side of adapter



9009-4/...-HW

Adattatore simmetrico a 4 conduttori (3 fasi) con selettore di fase regolabile e leggibile anche di lato
Symmetric 4 conductors (3 phase) adapter with phase selector and indicator accessible and visible from side of adapter



9209/...

Adattatore asimmetrico a 6 conduttori (3 fasi + sistema di controllo)
Asymmetric 6 conductors adapter (3 phase + control system)



9209-4/...

Adattatore asimmetrico a 4 conduttori (3 fasi)
Asymmetric 4 conductors (3 phase) adapter

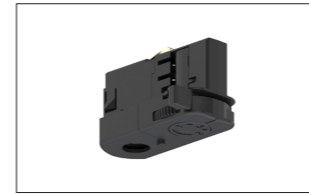

9409-4/...

Adattatore compatto a 4 conduttori (3 fasi)
Compact 4 conductors (3 phase) adapter

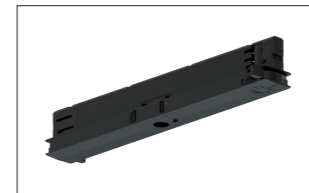

9409-DRI-SM/...-N

Adattatore a 6 conduttori (3 fasi + sistema di controllo) non brandizzato fornito smontato e senza driver
6 conductors (3 phase+ control system) adapter with no brand supplied disassembled and without driver

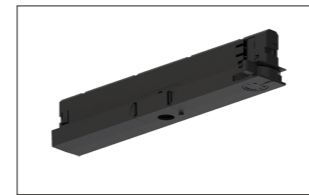

9409-4-DRI-SM/...-N

Adattatore a 4 conduttori (3 fasi) non brandizzato fornito smontato e senza driver
4 conductors (3 phase) adapter with no brand supplied disassembled and without driver

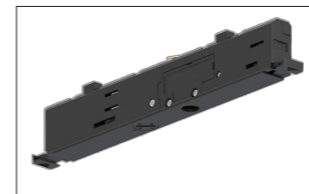

9999/...

Adattatore a scomparsa a 6 conduttori (3 fasi + sistema di controllo)
Concealed 6 conductors adapter (3 phase + control system)



9999-4/...

Adattatore a scomparsa a 4 conduttori (3 fasi)
Concealed 4 conductors adapter (3 phase)



ADATTATORI CON DRIVER INTEGRATO PER APPARECCHI STANDARD (SIDE DOWN)
ADAPTERS WITH INTEGRATED DRIVER FOR STANDARD LUMINAIRES (SIDE DOWN)

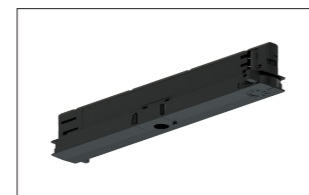

9409-DRI/...-N

Adattatore a 6 conduttori (3 fasi + sistema di controllo) con driver integrato
6 conductors (3 phase+ control system) adapter with integrated driver



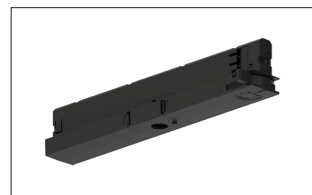

9409-4-DRI/...S2-N-1

Adattatore a 4 conduttori (3 fasi) con driver integrato
4 conductors (3 phase) adapter with integrated driver

W G B



9999-DRI/...

Adattatore a scomparsa a 6 conduttori (3 fasi + sistema di controllo) con driver integrato
Concealed 6 conductors adapter (3 phase + control system) with integrated driver

W B

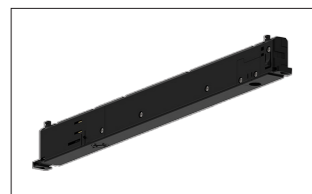

9999-4-DRI/...

Adattatore a scomparsa a 4 conduttori (3 fasi) con driver integrato
Concealed 4 conductors adapter (3 phase) with integrated driver

W B



9999-4-DRI/...-4-28

Adattatore a scomparsa a 6 conduttori (3 fasi + sistema di controllo) con driver integrato
Concealed 6 conductors adapter (3 phase + control system) with integrated driver

W B

ADATTATORI MECCANICI PER APPARECCHI STANDARD (SIDE DOWN)
MECHANICAL ADAPTERS (SIDE DOWN)

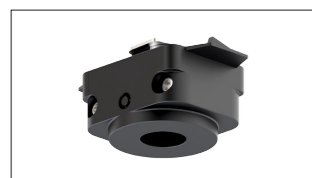

S-9000/M-...

Adattatore meccanico
Mechanical adapter

W G B

ACCESSORI DEGLI ADATTATORI
ADAPTER ACCESSORIES

Colori disponibili:
Available colours: W bianco white G grigio grey B nero black grigio raw



S-9009/BC-...

Bloccacavo esterno con vite in plastica
External cable lock with plastic screw

W G B

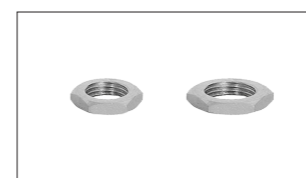

S-9009/D-M10
S-9009/D-M13

Dadi per raccordi (M10/M13)
Nuts for nipples (M10/M13)



S-9009/IP40-...

Carter IP40 per adattatori simmetrici 9009...
IP40 guard for 9009... symmetric adapters

W G B

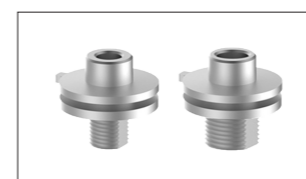

S-9009/M10
S-9009/M13

Raccordi (M10/M13) per adattatori 9009..., 9209... e 9019-MX-K2/...
Nipples (M10/M13) for adapters 9009..., 9209... and 9019-MX-K2/... ..

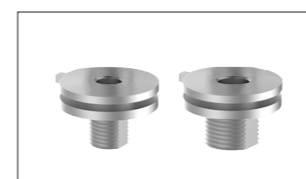

S-9009/M10-SC
S-9009/M13-SC

Raccordi (M10/M13) senza collare per adattatori 9009..., 9209..., 9409...e 9019-MX-K2/...
Nipples (M10/M13) without border for adapters 9009..., 9209..., 9409... and 9019-MX-K2/... ..

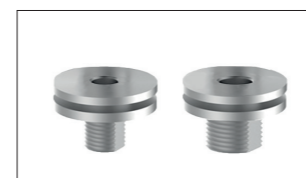

S-9009/M10-SC-L
S-9009/M13-SC-L

Raccordi (M10/M13) senza collare e fermo antirrotazione per adattatore 9019-MX-K1/...
Nipples (M10/M13) without border and anti-rotation pin for adapter 9019-MX-K1/... ..



S-9009/M10-FI

Raccordo con filetto interno M10 per adattatori 9009..., 9209..., 9409...e 9019-MX-K2/...
Nipples with M10 internal thread for adapters 9009..., 9209..., 9409... and 9019-MX-K2/... ..



S-9009/T-INS

Inserto per cablaggio adattatori
Installation tool insert for adapter wiring



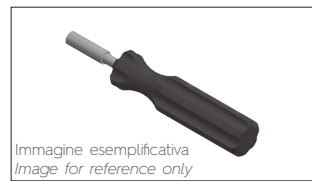

S-9009/T-HAN

Manico per inserto per cablaggio adattatori
Installation tool handle for adapters wiring



S-9009/10-...

Bloccacavo interno per adattatori simmetrici 9009...
Internal cable lock for 9009... symmetric adapters



S-9209/IP40-...

Carter IP40 per adattatori asimmetrici 9209...
IP40 guard for 9209... asymmetric adapters

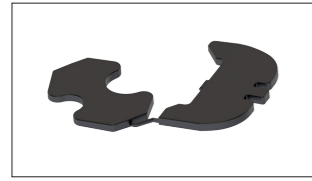

S-9209/20-...

Bloccacavo interno per adattatori asimmetrici 9209...
Internal cable lock for 9209... asymmetric adapters

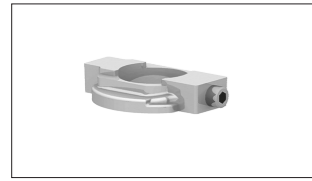

S-9209/51

Anello con grano per il blocco della rotazione del raccordo. Per gli adattatori 9009... , 9209... e S-9000/M-... . Da usare solo con S-9009/M10 e S-9009/M13
Ring with locking grub screw to avoid rotation of the nipple. For adapter 9009... ,9209... e S-9000/M-... . To be used only with S-9009/M10 and S-9009/M13



S-9409/9-B

Bloccacavo interno per adattatori 9409-4...
Internal cable lock for 9409-4... adapters



KIT-9909-ND/M...

Composto da:
· raccordo (M10/M13) per adattatori 9909-4/... 9999... e 9999-4...
· rondella antigiro

Composed by:
· nipple (M10/M13) for adapters 9909-4/... 9999... and 9999-4...
· Antirotation washer



BOX DRIVER E ACCESSORI
BOX DRIVER AND ACCESSORIES

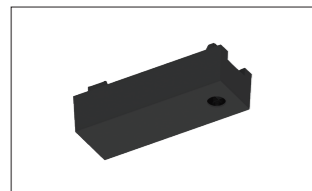

9209/BD-M...

Box driver LED. Da utilizzare con adattatori asimmetrici 9209...
LED driver box. To be used with asymmetric adapters 9209...

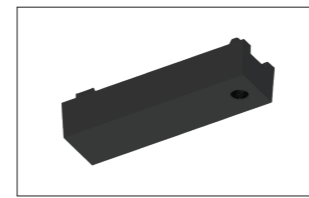

9209/BD-L...

Box driver LED. Da utilizzare con adattatori asimmetrici 9209...
LED driver box. To be used with asymmetric adapters 9209...

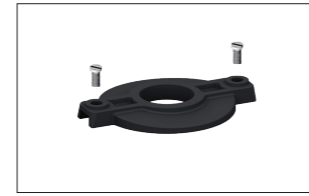

S-9209-BD/3-...

Copertura plastica e viti per per raccordi box driver LED
Plastic cover and screws for LED driver box nipples



S-9209-BD/M10
S-9209-BD/M13

Raccordi per box driver LED.
Nipples for LED driver box.



S-9209-BD-10/4-...

Riduttore per raccordo M10 per box driver LED
Spacer for LED driver box M10 threaded nipples



S-9209-BD-13/4-...

Riduttore per raccordo M13 per box driver LED
Spacer for LED driver box M13 threaded nipples



KIT-BD/M10...

Kit completo per fissaggio M10
Composto da:
· viti di fissaggio
· cover plastica per raccordo
· raccordo in alluminio filettato M10
· riduttore per raccordo M10

Complete kit for M10 fixing
Composed by:
· fixing screws
· plastic cover for nipple
· aluminium M10 threaded nipple
· spacer for M10 threaded nipple



KIT-BD/M13...

Kit completo per fissaggio M13
Composto da:
· viti di fissaggio
· cover plastica per raccordo
· raccordo in alluminio filettato M13
· riduttore per raccordo M13

Complete kit for M13 fixing
Composed by:
· fixing screws
· plastic cover for nipple
· aluminium M13 threaded nipple
· spacer for M13 threaded nipple



CONNESSIONI ELETTROMECCANICHE
ELECTRO-MECHANICAL CONNECTIONS

Colori disponibili: **W** bianco / Available colours: **W** white **B** nero / **B** black

—→ polarità - vista dall'alto (SD) / vista frontale (SU)

ALIMENTAZIONI
FEEDS

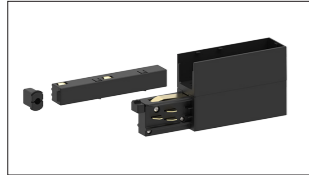

9001-MX48/B
9001-MX48/W

Testate di alimentazione
End Feeds

W **B**

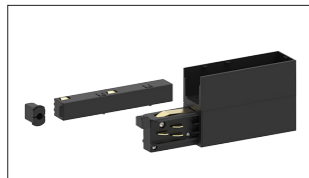
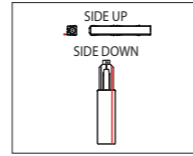

9002-MX48/B
9002-MX48/W

Testate di alimentazione
End Feeds

W **B**

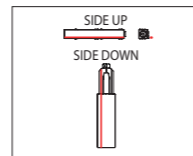

CONNESSIONI
CONNECTIONS



9003-MX48/B
9003-MX48/W

Giunto passante
Joining connector

W **B**



9003-MX48/B-M
9003-MX48/W-M

Connessione isolante
Insulating connection

W **B**



9011-MX48/B
9011-MX48/W

Giunto a L
L-joint

W **B**

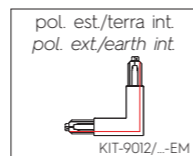

9012-MX48/B
9012-MX48/W

Giunto a T
T-joint

W **B**

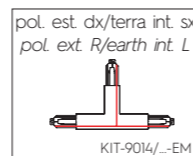

ACCESSORI DELLE CONNESSIONI
CONNECTION ACCESSORIES

Colori disponibili: **W** bianco / Available colours: **W** white **B** nero / **B** black



S-9001/115..

Guarnizione per testata di alimentazione.
Gasket for end feed.

W **B**

SAFETY FIRST!

A TRACK SYSTEM IS COMPLIANT TO THE RELEVANT STANDARDS ONLY IF IT PROVIDES 2 DEDICATED CIRCUITS (C1 and C2) FOR EMERGENCY LIGHTING, EACH ONE WITH ITS OWN NEUTRAL*

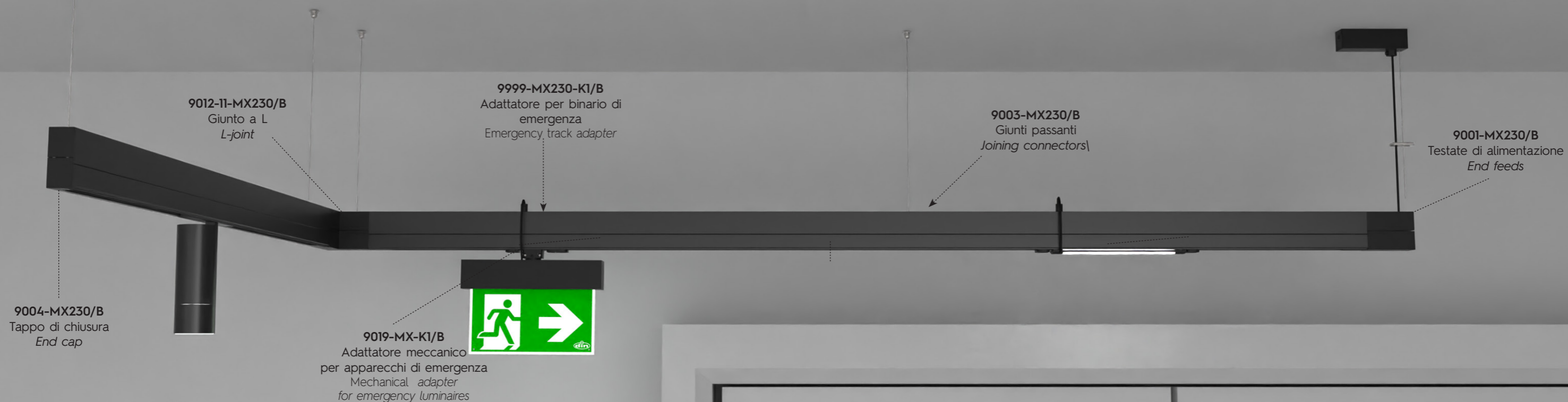

CODICI PRODOTTO
PRODUCT CODES

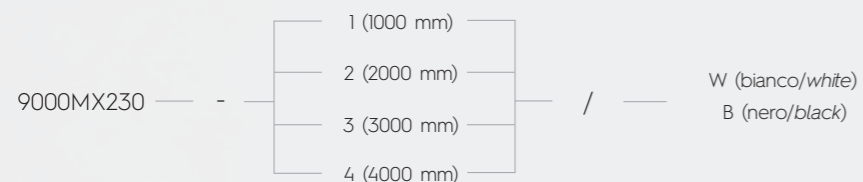

*ACCORDING TO INTERNATIONAL STANDARDS
IEC 60364-5-56:2018
VDE 0100-560:2022-10

A.A.G. Stucchi presenta MIXED 230V TRACK:

Questa gamma unisce le funzionalità di un binario **ONETRACK™ ADVANCE 230V** con DALI e un **binario a due circuiti 230V**.

Adatto per l'uso con apparecchi illuminanti di emergenza controllati tramite CBS.

A.A.G. Stucchi presents MIXED 230V TRACK:

Combining the functionalities of **ONETRACK™ ADVANCE 230V** with DALI and a **2 circuits 230V track**.

Suitable for use with main voltage emergency lighting fixtures controlled via CBS.

COME SCEGLIERE IL TUO BINARIO
HOW TO CHOOSE THE TRACK YOU NEED

MIXED 230V

BINARIO / TRACK

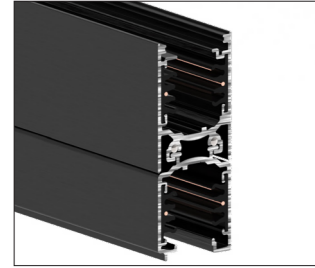

9000MX230-.../B
9000MX230-.../W

Colori disponibili: Available colours: **B** nero black RAL 9005 **W** bianco white RAL 9010

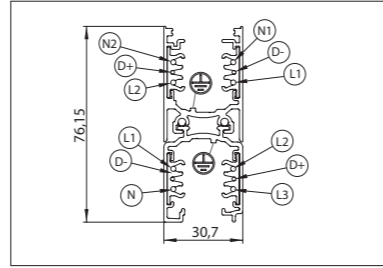

ACCESSORI PER BINARIO
TRACK ACCESSORIES

Colori disponibili: Available colours: **B** nero black **G** grigio grey **W** bianco white grezzo raw



9004-MX230/B
9004-MX230/W

Tappo di chiusura con vite di blocco
End cap with locking screw

W **B**



S-9000/H-...

Gancio di sospensione
Suspension hook

W **B**

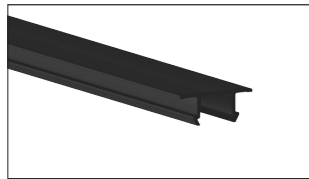

S-9000/GP-...

Guaina di protezione supplementare
Additional cover strip

W **B**



S-9000/TP-G

Tappo di protezione supplementare per asole binario
Additional closure cap for track slots

G

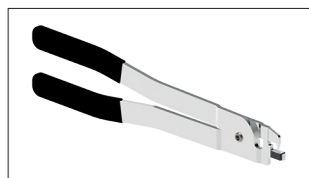

S-9000/T

Tronchesi per taglio conduttori del binario (SIDE DOWN)
Cutting tools for track conductors (SIDE DOWN)

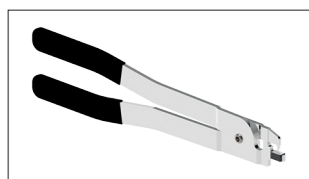

S-9000/TA

Pinza per bloccaggio pvc in caso di taglio binario (SIDE UP)
PVC locking clamp for track cut (SIDE UP)

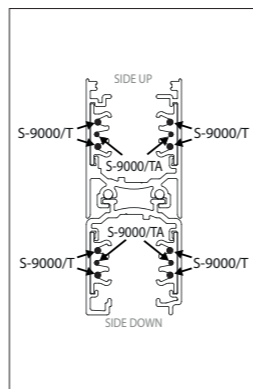

ACCESSORI PER IL FISSAGGIO DEL BINARIO
TRACK FIXING ACCESSORIES

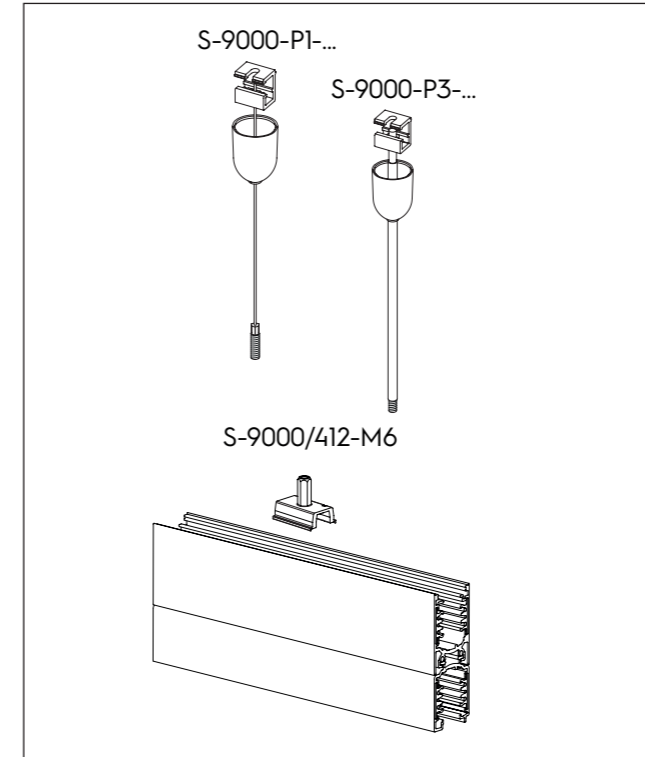

Set per fissaggio a sospensione
Suspension sets

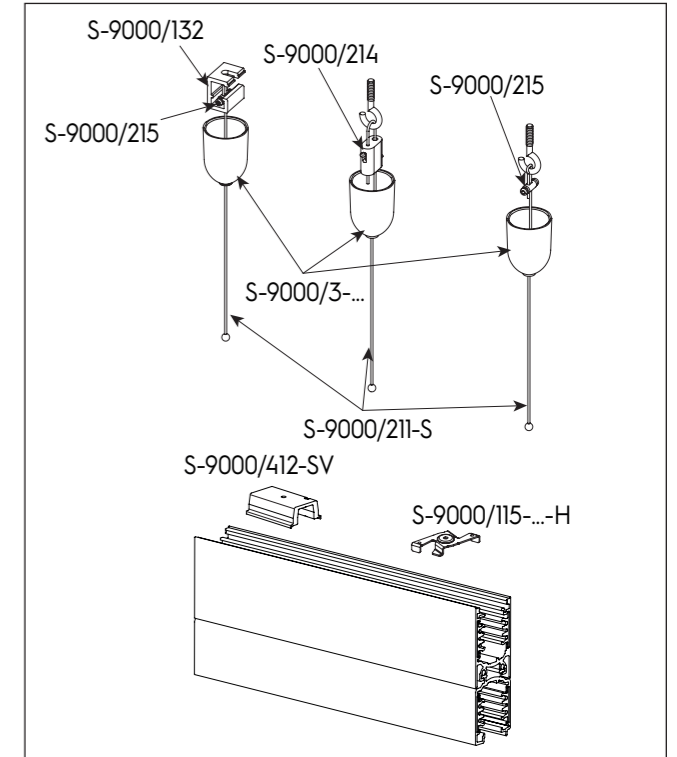

Accessori per sospensione con regolazione a plafone
Suspension accessories with ceiling adjustment

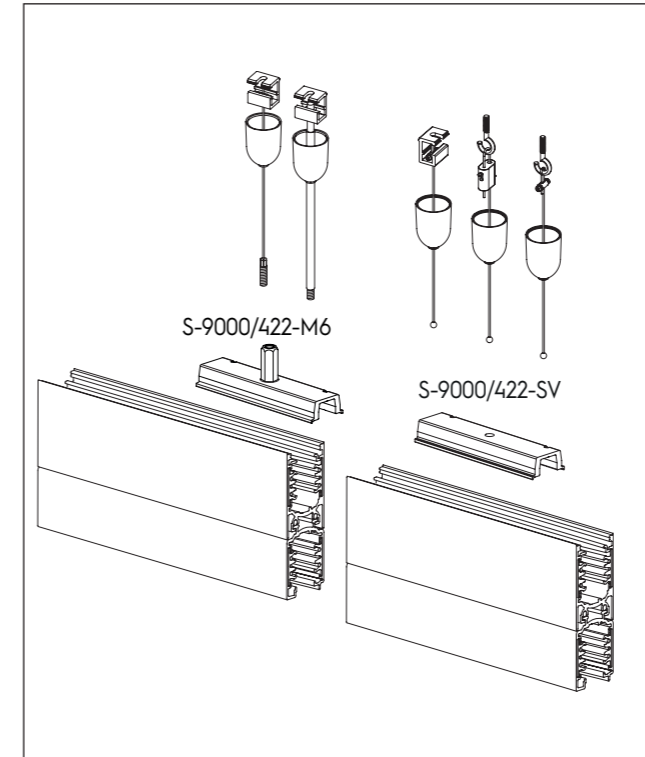

Accessori per giunzioni in fila continua
Accessories for "in row" use junctions

SET PER FISSAGGIO A SOSPENSIONE
SUSPENSION SETS

Colori disponibili:
Available colours:

W bianco white	RAL 9010	B nero black	RAL 9005
G grigio grey	RAL 7035	gr grezzo raw	



**S-9000-P1-1.5-...; S-9000-P1-3-...;
S-9000-P1-5-...**

Composto da:
· staffa per fissaggio a soffitto
· tenditore a vite
· rosone plastico
· filo in acciaio Ø 1,5mm (L=1500/3000/5000mm)
con terminale M6

Includes:
· ceiling bracket
· screw gripper
· plastic cup
· steel cable Ø 1,5mm (L=1500/3000/5000mm)
with M6 threaded end

W G B



S-9000-P3-...

Composto da:
· staffa per fissaggio a soffitto
· dado M6
· rosone plastico
· barra filettata M6 (L=1000mm)
con guaina di copertura

Includes:
· ceiling bracket
· M6 nut
· plastic round head
· M6 threaded bar (L=1000mm)
with cover strip

W G B gr

ACCESSORI SINGOLI
SINGLE ACCESSORIES

Colori disponibili:
Available colours:

W bianco white	RAL 9010	W2 nero black	RAL 9016
B nero black	RAL 9005	G grigio grey	alluminio grezzo raw aluminium

ROSONI
CUPS



S-9000/4-...

Rosone plastico per barra filettata M6
Plastic cup for steel M6 threaded bar

W G B

STAFFE PER FISSAGGIO A PLAFONE
CEILING FIXING BRACKET

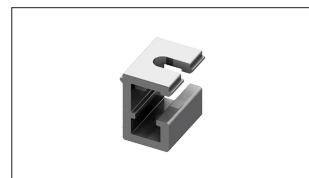

S-9000/132

Staffa per fissaggio a plafone per sospensioni
Ceiling bracket for suspensions



CLIP
CLAMPS



S-9000/115-...-H

Clip in acciaio verniciato
Clamp in painted steel

W G B

STAFFE
BRACKETS



S-9000/412-M6-...

Staffa corta per sospensioni con foro filettato M6
Short bracket for suspensions with threaded hole M6

W B

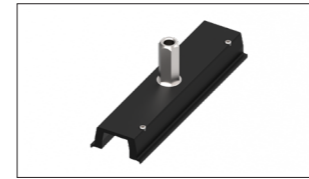

S-9000/422-M6-...

Staffa media per sospensioni con foro filettato M6
Medium bracket for suspensions with threaded hole M6

W B



S-9000/412-SV-...

Staffa corta per sospensioni con foro per cavo in acciaio con sfera
Short bracket for suspensions with hole for steel cable with sphere

W B



S-9000/422-SV-...

Staffa media per sospensioni con foro per cavo in acciaio con sfera
Medium bracket for suspensions with hole for steel cable with sphere

W B

CAVI
CABLES



S-9000/211-S-...

Filo in acciaio con terminale a sfera ø1,5mm (...=L 1500/3000/5000m)
Steel cable with spherical end ø 1,5mm (...=L 1500/3000/5000m)



TENDITORI
GRIPPERS



S-9000/214

Tenditore automatico
Automatic lock



S-9000/215

Tenditore a vite
Screw gripper



ADATTATORI ADAPTERS

Gli adattatori E-TRACK hanno un selettore di fase che permette di **mantenere la selezione effettuata** anche se l'adattatore viene spostato e/o reinserito nel binario. Questo permette inoltre di effettuare la selezione di fase **prima del montaggio** semplificando l'operazione.
Adattatori 9009... e 9209...: carico massimo **100N**. Momento di flessione massimo **5Nm**.
ATTENZIONE! per garantire la certificazione del sistema è necessario utilizzare sempre i blocchi meccanici degli adattatori contenuti nei kit.

E-TRACK adapters phase selector allows to **maintain the selected phase** even though the adapter is attached/detached or re-attached to the track. This gives also the possibility to select the phase **before the installation** making it easier.
9009... and 9209... adapters: maximum load **100N**. Maximum resistance to bending moment **5Nm**.
WARNING: to guarantee the system certification it is mandatory to use the mechanical locks of the adapters included in the kit.

Tipo di alimentazione di emergenza: **CBS** con sistema batterie centralizzate
Power supply emergency type: **CBS** with centralized battery system
Colori disponibili: **W** bianco / Available colours: **W** white **G** grigio / grey **B** nero / black

ADATTATORI PER APPARECCHI D'EMERGENZA SENZA DRIVER (SIDE UP) EMERGENCY FIXTURES ADAPTERS WITHOUT DRIVER (SIDE UP)



9999-MX230-K1/B
9999-MX230-K1/W

Kit adattatore simmetrico a 4 conduttori con blocchi meccanici di sicurezza
Symmetrical 4-conductor adapter with release levers and mechanical safety locks kit

W **B** **CBS**

ADATTATORI MECCANICI PER APPARECCHI D'EMERGENZA (SIDE DOWN) EMERGENCY FIXTURES MECHANICAL ADAPTERS (SIDE DOWN)

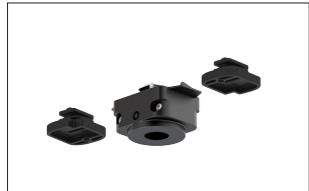

9019-MX-K1/B
9019-MX-K1/W

Kit adattatore meccanico con blocchi meccanici di sicurezza
Mechanical adapter with mechanical safety locks kit

W **B**



9019-MX-K2/B
9019-MX-K2/W

Kit adattatore simmetrico con leve di sgancio e blocchi meccanici di sicurezza
Symmetric adapter with release levers and mechanical safety locks kit

W **B**

ADATTATORI SENZA DRIVER PER APPARECCHI STANDARD (SIDE DOWN) ADAPTERS WITHOUT DRIVER FOR STANDARD LUMINAIRES (SIDE DOWN)



9009/...

Adattatore simmetrico a 6 conduttori (3 fasi + sistema di controllo)
Symmetric 6 conductors adapter (3 phase + control system)

W **G** **B**



9009-4/...

Adattatore simmetrico a 4 conduttori (3 fasi)
Symmetric 4 conductors (3 phase) adapter

W **G** **B**

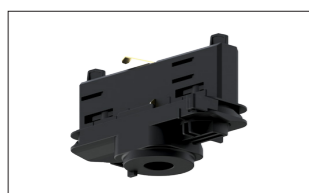

9009/...-HW

Adattatore simmetrico a 6 conduttori (3 fasi + sistema di controllo) con selettore di fase regolabile e leggibile anche di lato
Symmetric 6 conductors adapter (3 phase + control system) with phase selector and indicator accessible and visible from side of adapter

W **G** **B**



9009-4/...-HW

Adattatore simmetrico a 4 conduttori (3 fasi) con selettore di fase regolabile e leggibile anche di lato
Symmetric 4 conductors (3 phase) adapter with phase selector and indicator accessible and visible from side of adapter

W **G** **B**



9209/...

Adattatore asimmetrico a 6 conduttori (3 fasi + sistema di controllo)
Asymmetric 6 conductors adapter (3 phase + control system)

W **G** **B**



9209-4/...

Adattatore asimmetrico a 4 conduttori (3 fasi)
Asymmetric 4 conductors (3 phase) adapter

W **G** **B**



9409-4/...

Adattatore compatto a 4 conduttori (3 fasi)
Compact 4 conductors (3 phase) adapter

W **G** **B**

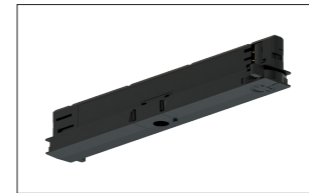

9409-DRI-SM/...-N

Adattatore a 6 conduttori (3 fasi + sistema di controllo) non brandizzato fornito smontato e senza driver
6 conductors (3 phase+ control system) adapter with no brand supplied disassembled and without driver

W **G** **B**

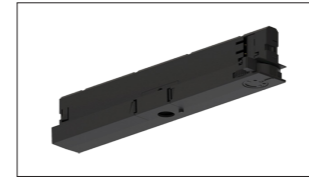

9409-4-DRI-SM/...-N

Adattatore a 4 conduttori (3 fasi) non brandizzato fornito smontato e senza driver
4 conductors (3 phase) adapter with no brand supplied disassembled and without driver

W **G** **B**

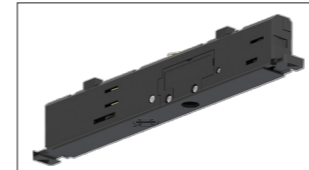

9999/...

Adattatore a scomparsa a 6 conduttori (3 fasi + sistema di controllo)
Concealed 6 conductors adapter (3 phase + control system)

W **B**

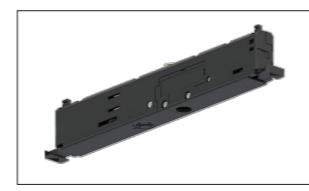

9999-4/...

Adattatore a scomparsa a 4 conduttori (3 fasi)
Concealed 4 conductors adapter (3 phase)

W **B**

ADATTATORI CON DRIVER INTEGRATO PER APPARECCHI STANDARD (SIDE DOWN)
ADAPTERS WITH INTEGRATED DRIVER FOR STANDARD LUMINAIRES (SIDE DOWN)

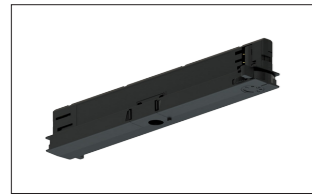

9409-DRI/...-N

Adattatore a 6 conduttori (3 fas + sistema di controllo) con driver integrato
6 conductors (3 phase+ control system) adapter with integrated driver

W G B

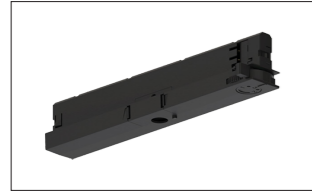

9409-4-DRI/...-S2-N-1

Adattatore a 4 conduttori (3 fasi) con driver integrato
4 conductors (3 phase) adapter with integrated driver

W G B



9999-DRI/...

Adattatore a scomparsa a 6 conduttori (3 fasi + sistema di controllo) con driver integrato
Concealed 6 conductors adapter (3 phase + control system) with integrated driver

W B

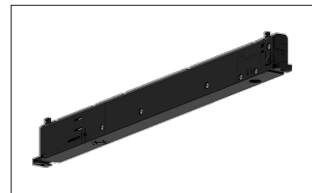

9999-4-DRI/...

Adattatore a scomparsa a 4 conduttori (3 fasi) con driver integrato
Concealed 4 conductors adapter (3 phase) with integrated driver

W B

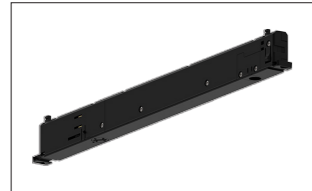

9999-4-DRI/...-4-28

Adattatore a scomparsa a 6 conduttori (3 fasi + sistema di controllo) con driver integrato
Concealed 4 conductors adapter (3 phase + control system) with integrated driver

W B

ACCESSORI DEGLI ADATTATORI
ADAPTER ACCESSORIES

Colori disponibili:
Available colours: W bianco white G grigio grey B nero black grezzo raw



S-9009/BC-...

Bloccacavo esterno con vite in plastica
External cable lock with plastic screw

W G B

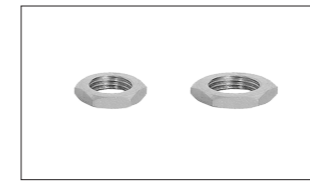

S-9009/D-M10
S-9009/D-M13

Dadi per raccordi (M10/M13)
Nuts for nipples (M10/M13)



S-9009/IP40-...

Carter IP40 per adattatori simmetrici 9009...
IP40 guard for 9009... symmetric adapters

W G B

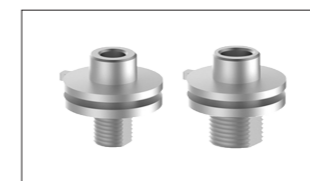

S-9009/M10
S-9009/M13

Raccordi (M10/M13) per adattatori 9009..., 9209... e 9019-MX-K2/...
Nipples (M10/M13) for adapters 9009..., 9209... and 9019-MX-K2/...

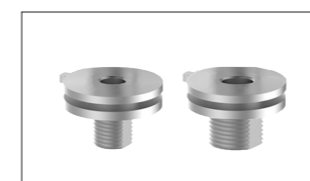

S-9009/M10-SC
S-9009/M13-SC

Raccordi (M10/M13) senza collare per adattatori 9009..., 9209..., 9409...e 9019-MX-K2/...
Nipples (M10/M13) without border for adapters 9009..., 9209..., 9409... and 9019-MX-K2/...

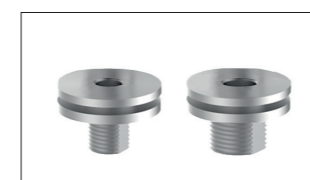

S-9009/M10-SC-L
S-9009/M13-SC-L

Raccordi (M10/M13) senza collare e fermo antirrotazione per adattatore 9019-MX-K1/...
Nipples (M10/M13) without border and anti-rotation pin for adapter 9019-MX-K1/...



S-9009/M10-FI

Raccordo con filetto interno M10 per adattatori 9009..., 9209..., 9409...e 9019-MX-K2/...
Nipples with M10 internal thread for adapters 9009..., 9209..., 9409... and 9019-MX-K2/...



S-9009/T-INS

Inserto per cablaggio adattatori
Installation tool insert for adapter wiring



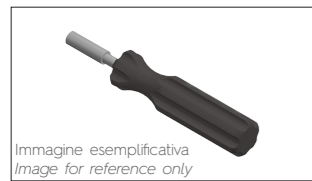

S-9009/T-HAN

Immagine esemplificativa
Image for reference only

Manico per inserto per cablaggio adattatori
Installation tool handle for adapters wiring



S-9009/10-...

Bloccacavo interno per adattatori simmetrici 9009...
Internal cable lock for 9009... symmetric adapters



S-9209/IP40-...

Carter IP40 per adattatori asimmetrici 9209...
IP40 guard for 9209... asymmetric adapters

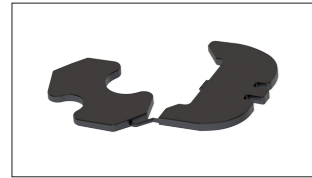

S-9209/20-...

Bloccacavo interno per adattatori asimmetrici 9209...
Internal cable lock for 9209... asymmetric adapters

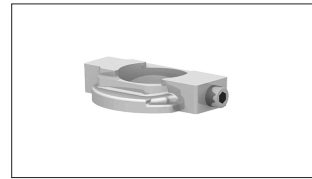

S-9209/51

Anello con grano per il blocco della rotazione del raccordo. Per gli adattatori 9009... , 9209... e S-9000/M-... . Da usare solo con S-9009/M10 e S-9009/M13
Ring with locking grub screw to avoid rotation of the nipple. For adapter 9009... ,9209... e S-9000/M-... . To be used only with S-9009/M10 and S-9009/M13



S-9409/9-B

Bloccacavo interno per adattatori 9409-4...
Internal cable lock for 9409-4... adapters



KIT-9909-ND/M...

Composto da:
· raccordo (M10/M13) per adattatori 9909-4/... 9999... e 9999-4...
· rondella antigiro

Composed by:
· nipple (M10/M13) for adapters 9909-4/... 9999... and 9999-4...
· Antirotation washer



BOX DRIVER E ACCESSORI
BOX DRIVER AND ACCESSORIES

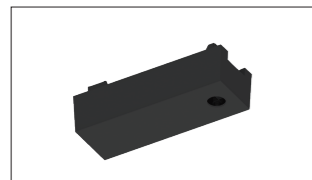

9209/BD-M...

Box driver LED. Da utilizzare con adattatori asimmetrici 9209...
LED driver box. To be used with asymmetric adapters 9209...

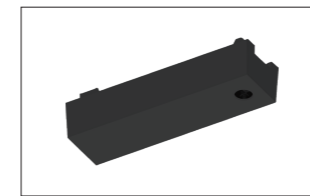

9209/BD-L...

Box driver LED. Da utilizzare con adattatori asimmetrici 9209...
LED driver box. To be used with asymmetric adapters 9209...

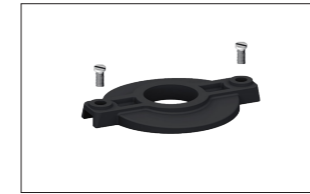

S-9209-BD/3-...

Copertura plastica e viti per per raccordi box driver LED
Plastic cover and screws for LED driver box nipples



S-9209-BD/M10
S-9209-BD/M13

Raccordi per box driver LED.
Nipples for LED driver box.



S-9209-BD-10/4-...

Riduttore per raccordo M10 per box driver LED
Spacer for LED driver box M10 threaded nipples



S-9209-BD-13/4-...

Riduttore per raccordo M13 per box driver LED
Spacer for LED driver box M13 threaded nipples



KIT-BD/M10...

Kit completo per fissaggio M10
Composto da:
· viti di fissaggio
· cover plastica per raccordo
· raccordo in alluminio filettato M10
· riduttore per raccordo M10

Complete kit for M10 fixing
Composed by:
· fixing screws
· plastic cover for nipple
· aluminium M10 threaded nipple
· spacer for M10 threaded nipple



KIT-BD/M13...

Kit completo per fissaggio M13
Composto da:
· viti di fissaggio
· cover plastica per raccordo
· raccordo in alluminio filettato M13
· riduttore per raccordo M13

Complete kit for M13 fixing
Composed by:
· fixing screws
· plastic cover for nipple
· aluminium M13 threaded nipple
· spacer for M13 threaded nipple



CONNESSIONI ELETTROMECCANICHE
ELECTRO-MECHANICAL CONNECTIONS

Colori disponibili:
Available colours: **W** bianco white **B** nero black

—→ polarità - vista dall'alto (SD) / vista frontale (SU)

ALIMENTAZIONI
FEEDS



9001-MX230/B
9001-MX230/W

Testate di alimentazione
End Feeds

W **B**

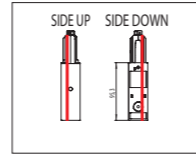

9002-MX230/B
9002-MX230/W

Testate di alimentazione
End Feeds

W **B**

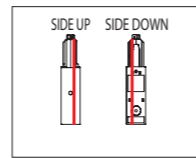

CONNESSIONI
CONNECTIONS



9003-MX230/B
9003-MX230/W

Giunto passante
Joining connector

W **B**



9003-MX230/B-M
9003-MX230/W-M

Connessione isolante
Insulating connection

W **B**



9011-12-MX230/B
9011-12-MX230/W

Giunto a L
L-joint

W **B**

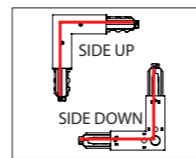

9012-11-MX230/B
9012-11-MX230/W

Giunto a L
L-joint

W **B**

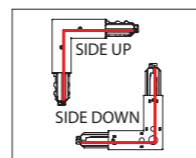

ACCESSORI DELLE CONNESSIONI
CONNECTION ACCESSORIES

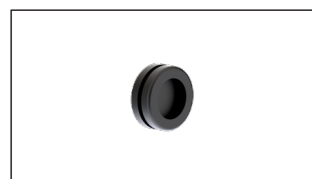

S-9001/115...

Guarnizione per testata di alimentazione.
Gasket for end feed.

W **B**

Colori disponibili:
Available colours: **W** bianco white **B** nero black

ESEMPI DI COMPOSIZIONE
COMPOSITION EXAMPLE

Track

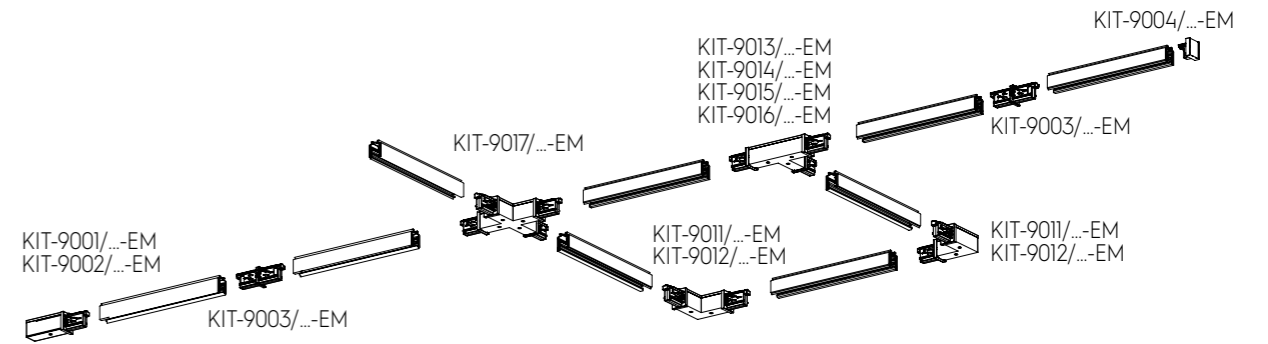

MIXED
48V Track

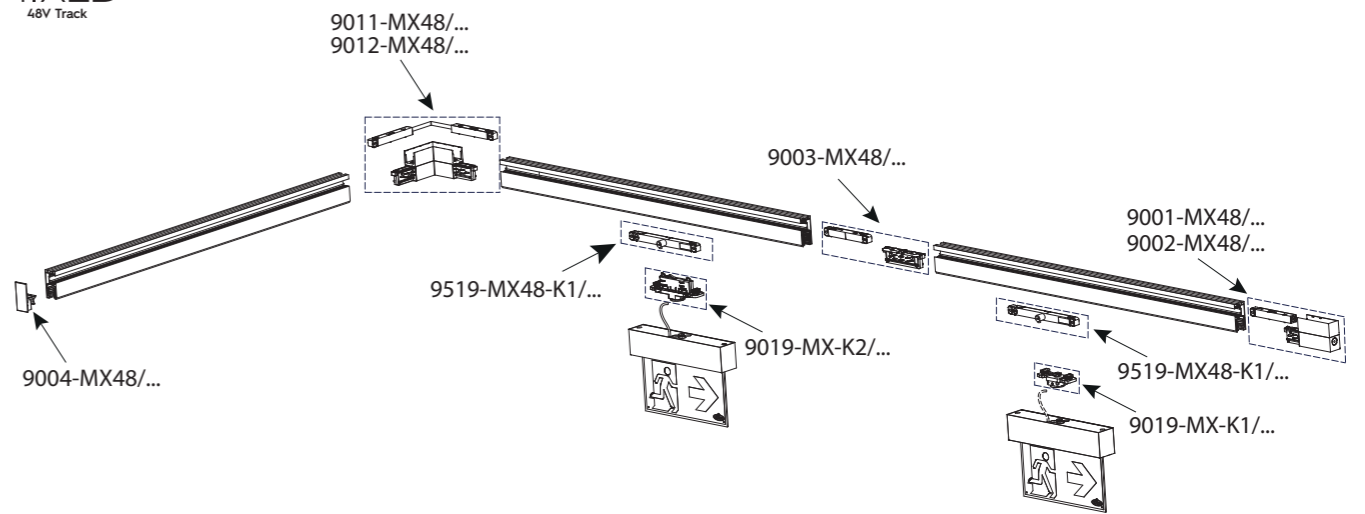

MIXED
230V Track

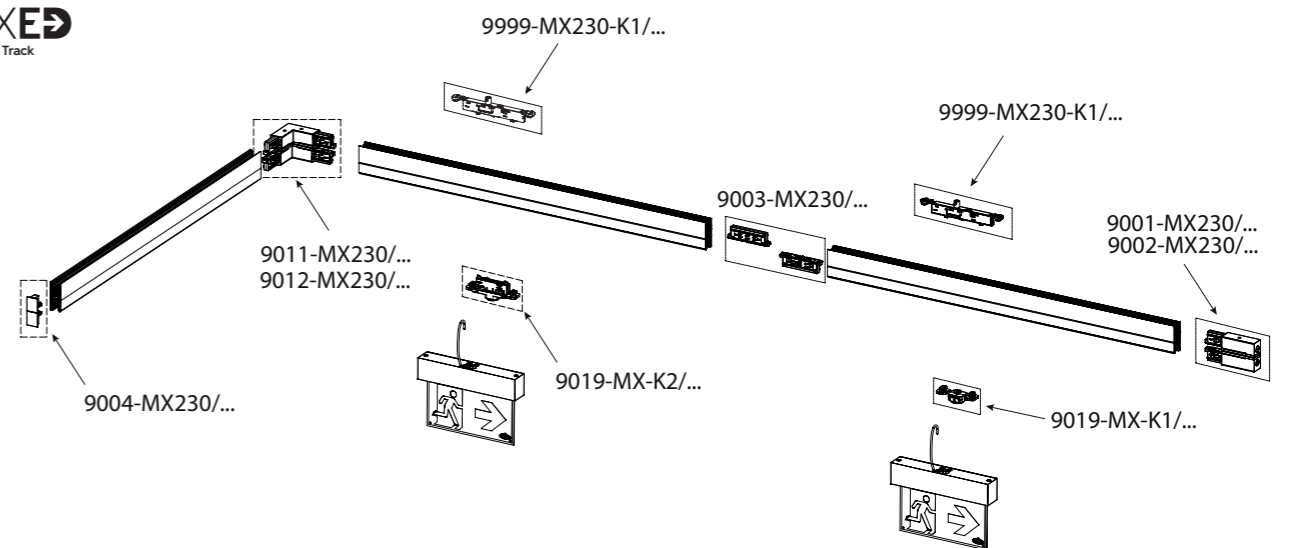

ATTENZIONE

Il distributore ha l'obbligo di informare l'utente sulle modalità di utilizzo di tutti i componenti forniti.
Materiali, disegni, programma di fabbricazione e confezioni possono subire modifiche o variazioni senza obbligo di preavviso.
Si declina ogni responsabilità per eventuali errori di stampa.

WARNING

*The manufacturer/distributor must provide its customers with guidance on the correct use of all components supplied.
Materials, designs, our development program and packages are subject to changes without notice.
We are not responsible for any printing mistakes.*

A.A.G. STUCCHI s.r.l. u.s.
Via IV Novembre 30/32, 23854
Olginate (LC) - ITALY
Ph. +39-0341-653111
Fax +39-0341-653250
info@aagstucchi.it

A.A.G. STUCCHI NORTH AMERICA, INC.
5080 North Royal Atlanta Drive
Tucker, GA 30084 - USA
Ph. +1-404-806-5399
northamerica@aagstucchi.com

A.A.G. STUCCHI ASIA PACIFIC LTD.
Unit 05, 20/F, W50, No.50 Wong Chuk Hang Road,
Hong Kong
Ph. +852-2578-8988
Fax +852-2571-5039
hongkong@aagstucchi.hk

A.A.G. STUCCHI SHANGHAI LTD.
Rm A1109, No.1555, Kong Jiang Rd, YangPu District,
200092, Shanghai, China
Ph. +86 021 80213518
Fax +86 021 80213506
Mobile +86 13601972149
east@aagstucchi.hk

aagstucchi.it



Aggiornamento Marzo 2024
March 2024 update