











Use and Configuration Manual**41002 - 41005**

Due Fili Plus audio, audio/video units

Index

General information	4
Description	4
Warnings and advice	5
Keys and status LEDs	6
Status LEDs	7
Operation	8
Functions	9
Pan/Zoom function (only for 41005)	9
Picture control (41005)	10
Dusk/dawn function	10
Teleloop and control voice synthesis function	10
Configurations	11
Installer menu	12
Using the push buttons to navigate the menu	12
LEDs and menu structure	13
 Selecting order of push button modules	14
 Push button remapping	16
 Automatic procedure for assigning IDs to Indoor Stations	18
 Automatic procedure for assigning IDs to Outdoor Stations	19
 Set lock time	20
 Set talk time	21
 Setting the audio level	22
 Reset factory settings/Restart/Reset internal memory	23
Reset factory settings	24
Restart entire system	25
External memory reset	25
 Setting push button behaviour according to the call button	26
 Camera enabling (only 41002)	28
 Common locks	29
Advanced configuration with SaveProg software	32

General information

Description

Audio electronic unit with input for CCTV type external camera (41002) and audio/video electronic unit, wide-angle teleloop (41005) for Pixel Series, Outdoor Stations, for use in systems with Due Fili Plus technology. Both are equipped with:

- full-duplex audio with Larsen effect removal;
- automatic gain control on loudspeaker power output, according to the type of installation;
- four traditional call buttons to the Indoor Stations in two rows (2+2).
- input for optional local additional power supply unit (with power supply unit 6923)

The audio/video version electronic unit (41005) is equipped with:

- cameras and white LED lighting in the recording area with automatic brightness control according to the ambient light.
- camera with pan/zoom function controlled directly from the Indoor Station;
- two picture control modes: standard and portrait enhanced;

The audio electronic unit with input for camera (41002) works by default as audio only.

Nevertheless, transmission of the video signal can be enabled via [SaveProg](#) or by following the "Configuration" procedure described below (in chapter: Configuration - [Camera enabling](#)).

N.B.: When there is no video signal at the M-V terminals, any video entryphones that receive the call from this module will switch on but will not show a valid image.

This is not a malfunction.



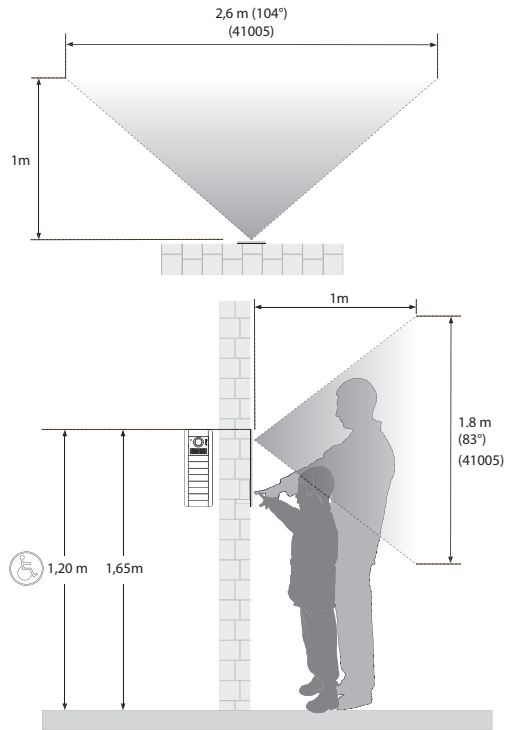

Warnings and advice

Audio frequency function for hearing aids (Teleloop)

The electronic unit can be used by people wearing hearing aids.



For correct functioning of the hearing aid, please refer to its instruction manual.

Any metal objects or electronic equipment in the vicinity may affect the quality of the sound received by the hearing aid.

Keys and status LEDs

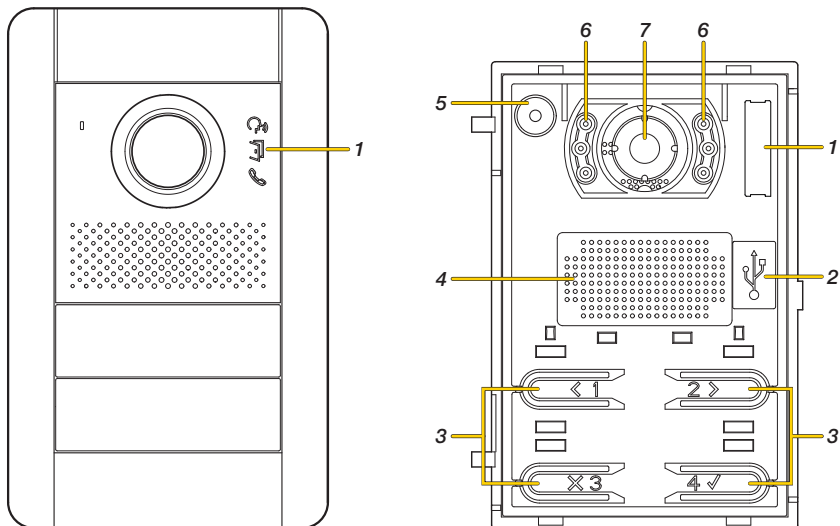
The TAB 7559 video entryphone can be operated using the touch keys described below.





1.  LED for light signals, see [Status LEDs](#)
2. Mini USB connector for configuration via PC and specific software
3.  Call buttons and Configuration
4. Speaker
5. Microphone
6. Recording area lighting LED
Camera (only 41005)

N.B.: the aesthetic finish is purely indicative

Status LEDs

Some of the LEDs illustrated below only come on in certain conditions.

LED	DESCRIPTION
	When on, communication is active, when flashing the call is under way
	When on, it signals the Bus is busy, when flashing communication was unsuccessful
	It turns on when the lock is operated

RED LED :

Situation	On (s)	Period (s)	Duration (s)
Attempt to call with BUS busy	0.1	0.2	2
Call to Indoor Station with ringtone mute	0.1	0.2	5
Call to Indoor Station busy	0.2	0.4	5
The Indoor Station called does not exist	0.1	0.2	1
Secondary ID assignment with parent > 50	0.1	0.2	1

WHITE LEDS:

Situation	On (s)	Period (s)
The chosen configuration has a value that does not fall within the standard range (it was changed with SaveProg)	0.1	0.5
Configuration is being reset to the factory value	0.1	0.2
Input for automatic ID assignment to Indoor Stations pending choice of push button to start with	0.5	1
The Outdoor Station is verifying whether another one with the same ID exists	0.25	1
Pending verification whether another Outdoor Station with the same ID exists	0.25 N.B.: they are offset by 0,25s from one another, giving the impression of clockwise rotation	1
Push button remapping	The LED paired with the button to be remapped remains permanently lit	N.O.
Pending sorting of additional push button modules	0.5	1

The situation of remaining in bootloader lasts 10 s from entry.

It exits automatically if the update is not started.

The situation is signalled by the green LED signalling active communication/call under way coming on, and if the electronic unit is powered by BUS, simultaneously with the lighting of a single white LED, the bottom right one.

Operation

N.B.: from this paragraph onwards, only the audio/video electronic unit 41005 will be illustrated; however, the functions described also apply for the Audio electronic unit 41002, except where specified.

Calls to Indoor Stations

the audio/video electronic unit 41005 can manage up to 4 calls to Indoor Stations, using four traditional push buttons in two rows (2+2) and, in combination with additional push button modules 41010 (41011), up to a maximum of 84 button calls.

Lock release control and additional push buttons

An electrical lock connected directly to terminals S+ and S- can be controlled and an additional local push button to release a door lock to terminals CA+ and CA-.

Alternatively to terminals CA+ and CA- they can be configured using the [SaveProg](#) software, as input of a sensor for signalling "Door open".

Dusk/dawn function

Dusk/dawn function for automatically adjusting the brightness according to the ambient light.

This adjustment affects the white LEDs lighting the recording area (only for 41005), and the key backlighting LEDs.

Teleloop

Hearing-impaired function for hearing aid wearers

Basic and advanced configuration

The basic configuration of the Electronic unit is possible using the 4 push buttons on the front and the related LEDs for the following parameters:

- selecting order of push button modules, push button remapping and default grouping of push buttons;
- automatic configuration of Indoor Station and Outdoor Station addresses;
- lock/talk time and audio level setting;
- configuration of common locks
- reset factory settings and external memory;
- restart of all devices;
- camera enabling (41002).

Moreover, the Electronic unit can be configured in an advanced way using the [SaveProg](#) software.

Functions

Pan/Zoom function (only for 41005)

This function of the Electronic Unit allows an Indoor Station with specific characteristics to zoom the image recorded by the camera.

Please refer to [SaveProg](#) for configuration details.

Example of the pan/zoom function with Indoor Station Tab7549

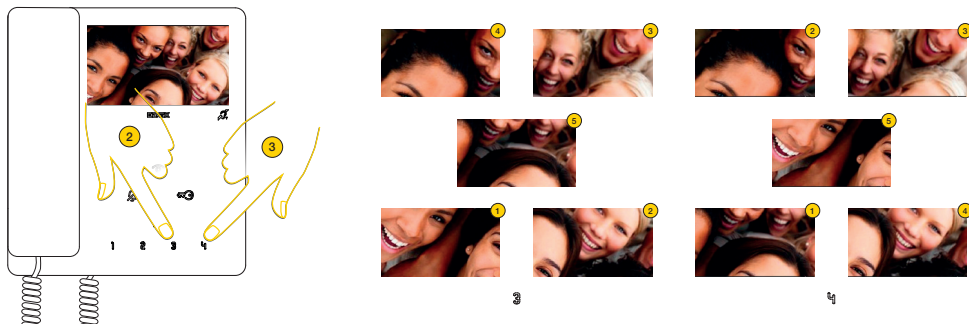

The device performs a zoom divided up into 5 zones

2. Press to display the zones in sequence anti-clockwise
3. Press to display the zones in sequence clockwise

In both cases, once the sequence is finished, press the key again to return to the normal display

Picture control (41005)

The standard mode provides optimal operation in typical environmental conditions, while the enhanced portrait mode highlights the caller in a backlit situation (such as at dawn).

Can be selected with [SaveProg.](#)

Dusk/dawn function

This lets you enable automatic brightness control of the Outdoor Station backlighting according to the ambient light brightness.

Can be selected with [SaveProg.](#)

Teleloop and control voice synthesis function

Electronic units 41002 and 41005 are ideal for people who are physically challenged, wear a hearing aid or are partially sighted.

Enable the hearing aid, referring to its instruction manual.

Note: any metal objects or electronic equipment nearby may compromise the quality of the sound received by the hearing aid.

Control voice synthesis can be enabled with [SaveProg.](#)

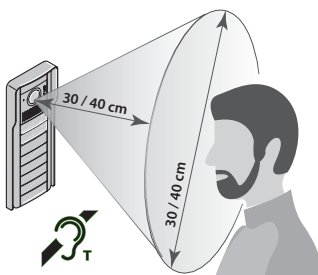

Configurations

Configuration of the Electronic unit is done using the **SaveProg** system software.

However, some parameters can be modified using the Electronic unit itself, using the 4 basic push buttons and the 4 related signalling LEDs.

In some cases the push buttons and LEDs of the additional modules are used too.

When combined with display module 41018, certain parameters can be configured using the programming menu on the same, in the Outdoor Station section.

N.B.: If modules 41002 and 41005 are connected to a display 41018, configuration using the 4 push buttons is not enabled.

If this is the case, use **SaveProg** or disconnect the display momentarily, wait 30 seconds for the entrance panel to recognise that the display is no longer connected, then proceed with configuration and then reconnect the display.

Access to programming





To access this menu, you need to enter a code comprising a sequence of push buttons. This sequence can be modified using **SaveProg**, or if the Electronic unit is combined with the Display Module 41018, from the menu on the latter.



Installer menu

To select the items to configure, browse the menu using only the 4 basic push buttons, whereas the position inside the menu is provided by the number and position of the LEDs that are on.

Using the push buttons to navigate the menu

	PREVIOUS	Selects the previous item in the menu
	NEXT	Selects the next item in the menu
	DEL	Exits the menu or cancels the configuration under way
	OK	Enters the selected menu item or confirms the start of a procedure

To navigate **the main level of the menu**, press the navigation keys and then the confirmation key to perform the function.

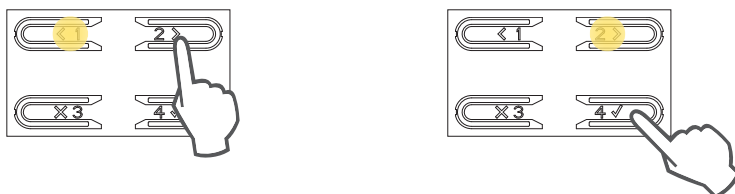

Some functions envisage a sub-menu. In this case the confirm key takes you to **secondary levels** of the menu.

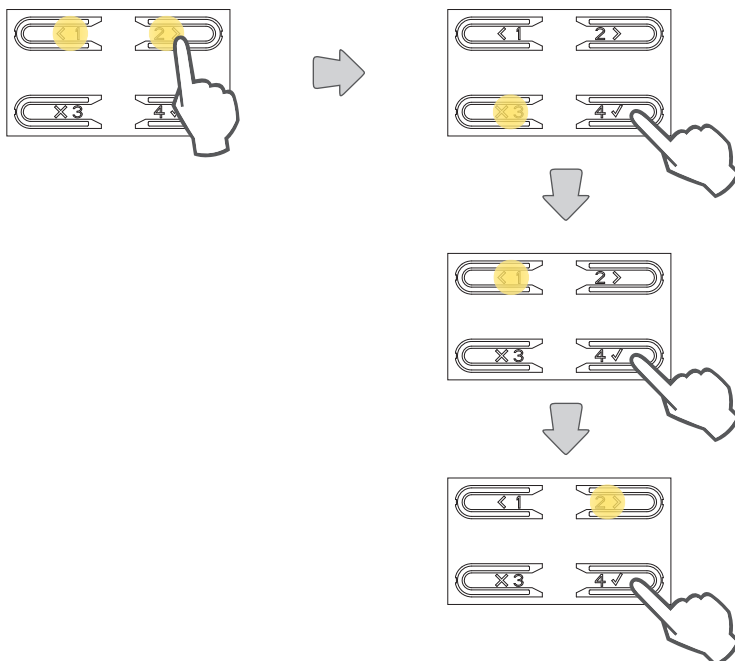

LEDs and menu structure

Selecting order of push button modules

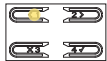

Push button remapping

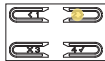

Automatic procedure for assigning IDs to Indoor Stations

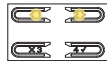

Automatic procedure for assigning IDs to Outdoor Stations

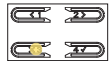

Lock time

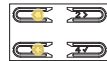

ID assignment for non secondary Outdoor Stations



ID assignment for all Outdoor Stations

1 second (default)

5 seconds

4 flashing LEDs:
Different value

Conversation time

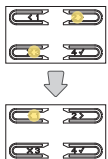

2 minutes (default)

5 minutes



4 flashing LEDs:
Different value

Audio level

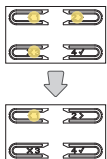

Level 1



Level 2



Level 3 (default)



Level 4

Reset factory settings/Restart/Reset internal memory

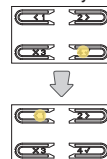

Reset factory settings (default)

Restart entire system



External memory reset

Setting push button behaviour according to the call button

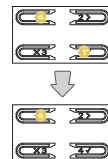

Single rocker button



Single axial button (default)

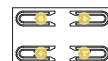

Double axial button

Enabling the camera

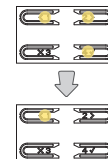

Camera disabled



Camera enabled (default)

Common locks

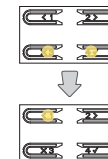

Start configuration of common locks

Selecting order of push button modules

This procedure allows you to assign the order of the additional push button modules connected to the Electronic unit. The order of the modules determines the numbering of the push buttons, the 4 push buttons of the electronic unit (41002-41005) are automatically put in first place.

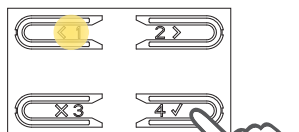

Press to choose how to order any additional push button modules connected to the Electronic unit

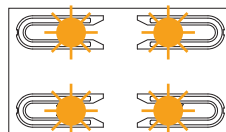

The electronic unit LEDs begin to flash slowly

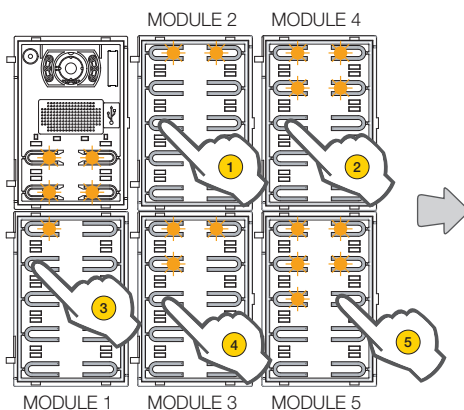
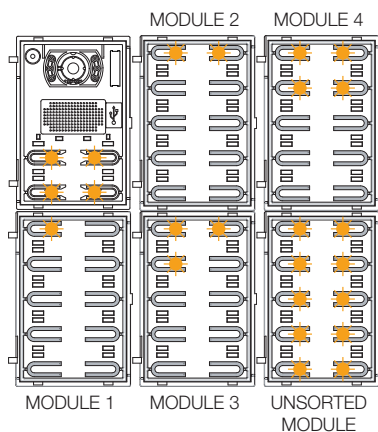

The LEDs on all the modules Art. 41010 will start flashing. The number of flashing LEDs for each module indicates their current position, so that module number 1 will only have one flashing LED and so on. If all the LEDs on a module are flashing, this means the module has not been sorted yet.

The initial order can be modified, by touching any push button in sequence according to the new desired order. After touching a push button, you have 10 seconds to touch the push button on the subsequent module.

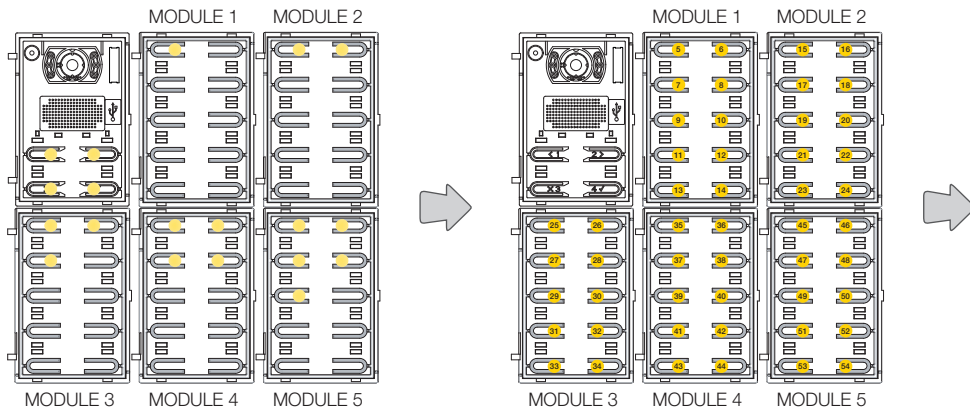

When the position of a module has been defined, a number of LEDs equal to the chosen position will light up permanently.

The push button at the top left of the first module will take the number 5, the push button at top left of the second module 15, and so on.

BEEP

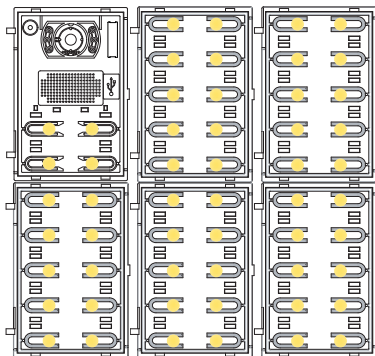

The procedure ends automatically after ordering the last module.
The LEDs light up permanently, the Outdoor Station emits a warning tone.

Push button remapping

By default each push button of the Outdoor Station calls an Indoor Station according to its sequential position. This correspondence can be modified using this procedure

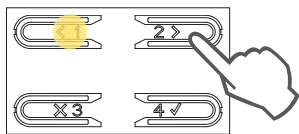

Press to select the function

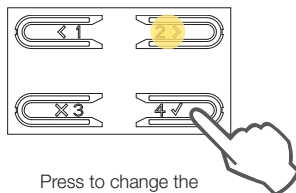

Press to change the correspondence between the push button and the Indoor Station.

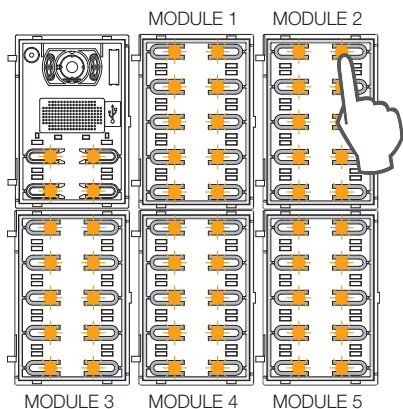

All the LEDs start flashing, press the push button to be remapped.

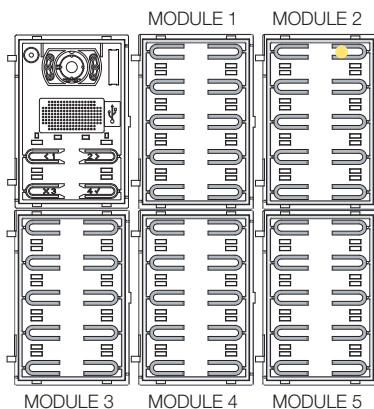

Only the corresponding LED stays on.

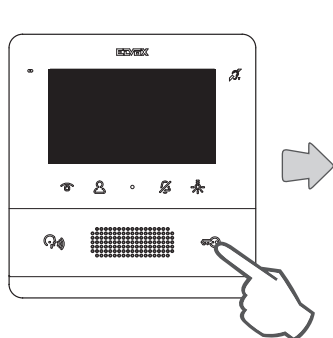

Press a key among the following on the Indoor Station to associate. Lock, F1, F2, relay activation or switchboard call

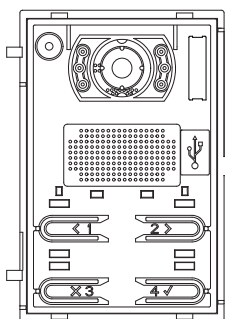

The Electronic unit emits an acoustic signal to confirm the new association

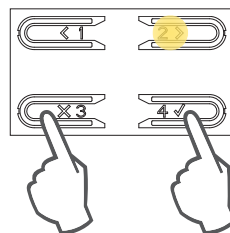

Press to exit programming

Press to remap another push button

Push button remapping deletion

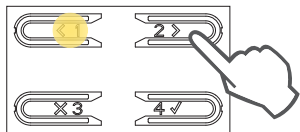

Press to select the function

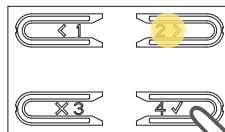

Press to change the correspondence between the push button and the Indoor Station.

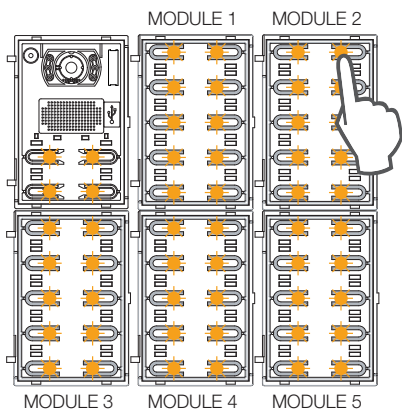

All the LEDs start flashing, press the push button whose remapping you wish to delete.

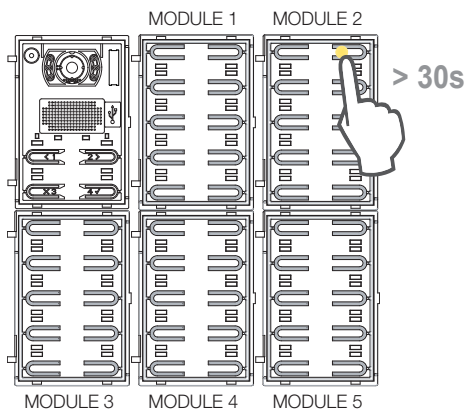

Only the corresponding LED stays on. Within 30 seconds, press the same push button to set its configuration to default.

Automatic procedure for assigning IDs to Indoor Stations

This procedure allows the automatic routing of Indoor Station IDs.

N.B.: the Electronic unit from which this configuration is performed, if vertical, must be Master.

Whereas if it is horizontal, it must function as Master via appropriate programming of one or more routers Art. 69RS.

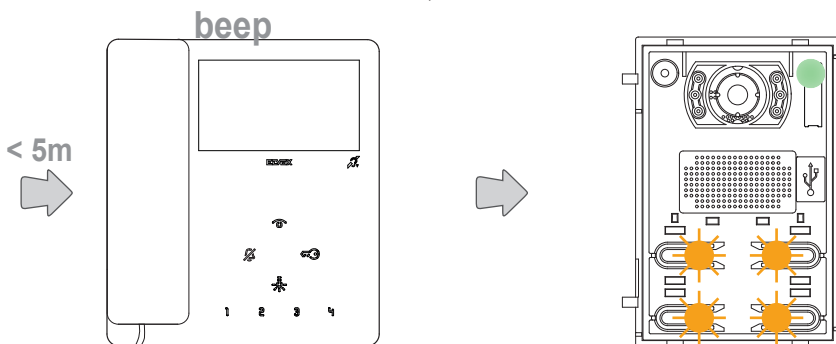
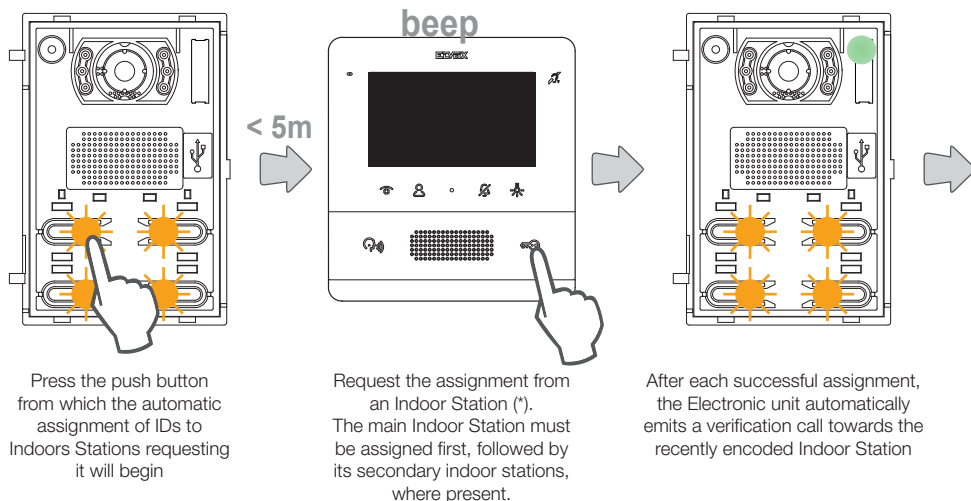
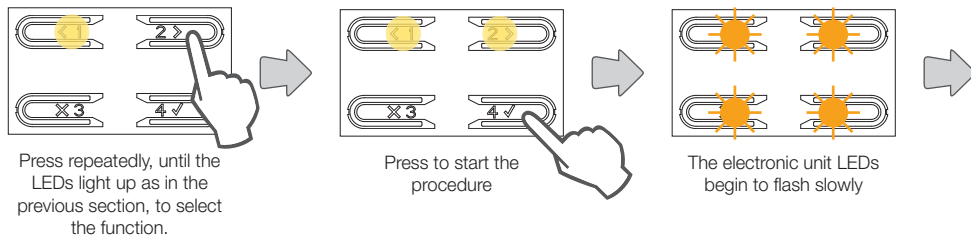

N.B.: the assignment varies according to the Indoor Station used, see specific documentation for details.

Automatic procedure for assigning IDs to Outdoor Stations

This procedure allows the automatic routing of Outdoor Station IDs (only Outdoor Stations that support automatic ID assigning).

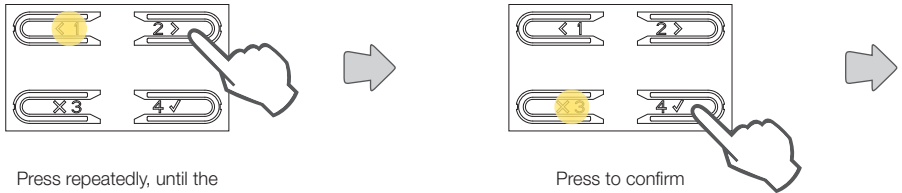

Press repeatedly, until the LEDs light up as in the previous section, to select the function.

Press to confirm

The lit LED indicates **the procedure selected**

Non-secondary Outdoor Stations (*)

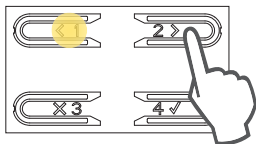

Press to select the procedure

All Outdoor Stations

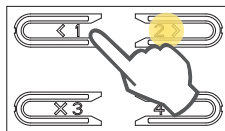

Press to confirm

(*) **Note:** Only do this in the Outdoor Station which you wish to assign the Master ID to (ID=1)

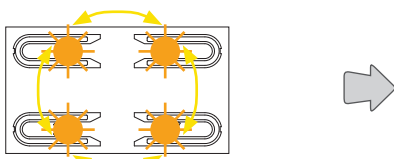

During the ID search, the push buttons on the Outdoor Stations involved turn on in turn clockwise, whereas during the ID uniqueness check, all the push buttons flash simultaneously.

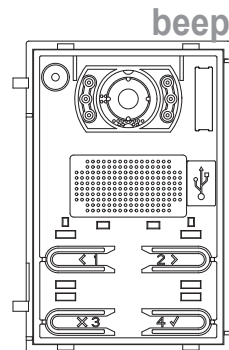

At the end of the procedure, the Outdoor Station emits an acoustic warning to confirm the procedure has ended and exits the programming menu.

(*) **N.B.:** in the event of ID assignment in the "Assignment for all Outdoor Stations" mode, if the Electronic unit already has a previously set ID, it will perform a check as to the existence of other Outdoor Stations with the same ID; if one is present, it will launch a new procedure for the assignment of a different ID for itself.

Set lock time

In this section, you can set the lock activation time. The settable values by the Electronic unit are 1 second (default) or 5 seconds.

Other values can be set (from 0/disabled to 254 seconds) using [SaveProg](#).

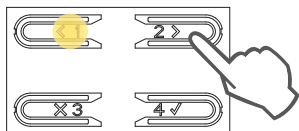

Press repeatedly, until the LEDs light up as in the previous section, to select the function.

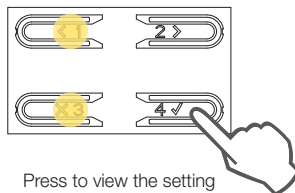

Press to view the setting status and if necessary amend it

The lit LED indicates **the lock time (*)**

1 second

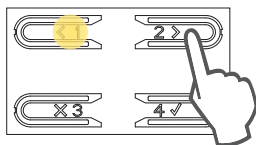

Press if necessary to amend the value

5 seconds

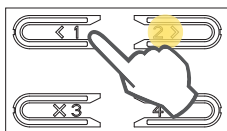

Press to confirm

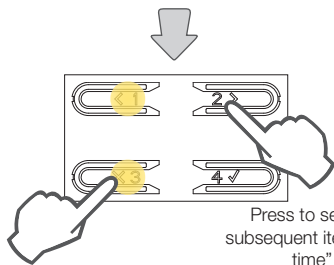

Press to set the subsequent item "Talk time"

Press to exit programming

(*) Warning if all 4 LEDs are flashing, this means you are changing a configuration made with [SaveProg](#) and so, once modified, you will be unable to restore it from the Electronic unit.

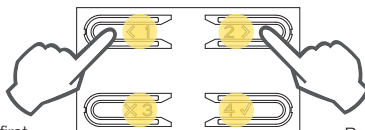

Press to set the first value possible

Press to set the last value possible

Set talk time

In this section, you can set the talk time. The settable values by the Electronic unit are 2 minutes (default) or 5 minutes. Other values can be set (from 10 a 2540 seconds) using SaveProg.

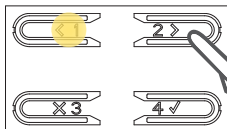

Press repeatedly, until the LEDs light up as in the previous section, to select the function.

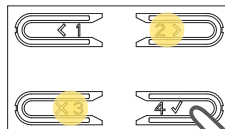

Press to view the setting status and if necessary amend it

The lit LED indicates **the current time (*)**

2 minutes

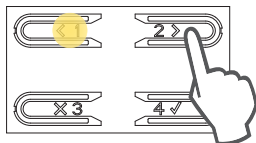

Press if necessary to amend the value

5 minutes

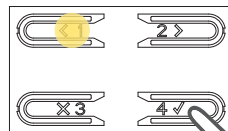
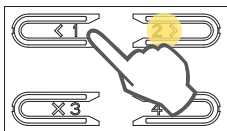

Press to confirm

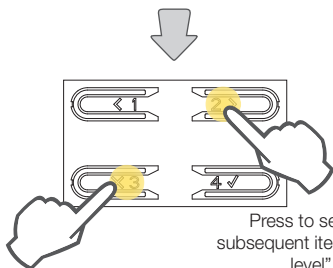

Press to set the subsequent item "Audio level"

Press to exit programming

(*) **Warning** if all 4 LEDs are flashing, this means you are changing a configuration made with **SaveProg** and so, once modified, you will be unable to restore it from the Electronic unit.

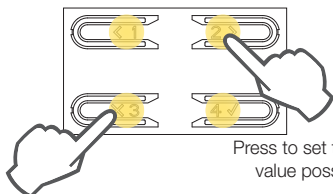

Press to set the last value possible

Press to set the first value possible

Setting the audio level

In this section, you can set one of the 4 audio levels.

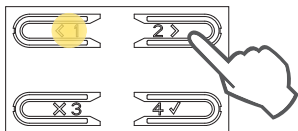

Press repeatedly, until the LEDs light up as in the previous section, to select the function.

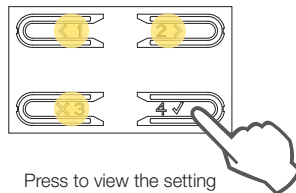

Press to view the setting status and if necessary amend it

The lit LED indicates **the current audio level**

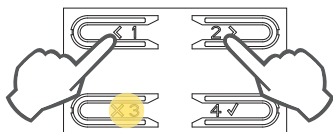
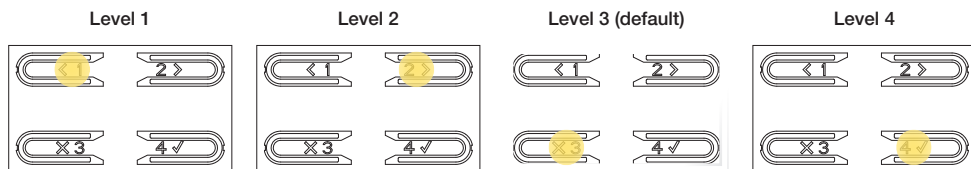

Press to select the previous option

Press to select the next option

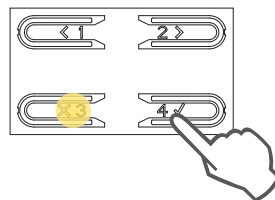

Press to confirm

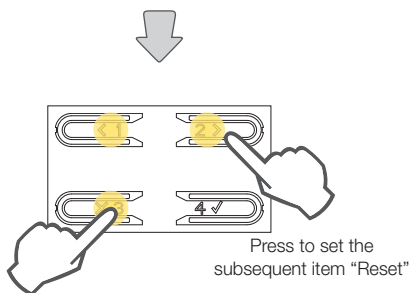

Press to exit programming

Press to set the subsequent item "Reset"

Reset factory settings/Restart/Reset internal memory

In this section you can [Reset the Electronic unit to its factory settings](#), [restart the entire system](#) and [reset the internal memory](#).

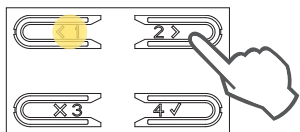

Press repeatedly, until the LEDs light up as in the previous section, to select the function.

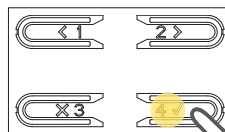

Press to confirm

The lit LED indicates **the procedure selected**

Reset Electronic unit to factory settings

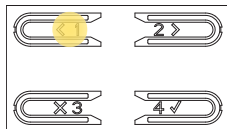

Restart system

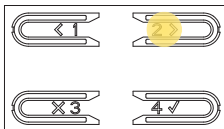

Reset internal memory

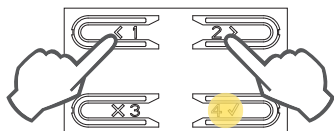
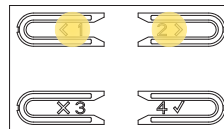

Press to select the previous option

Press to select the next option

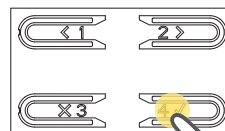

Press to confirm

Reset factory settings

This procedure resets all the settings of the Electronic unit to the factory values.

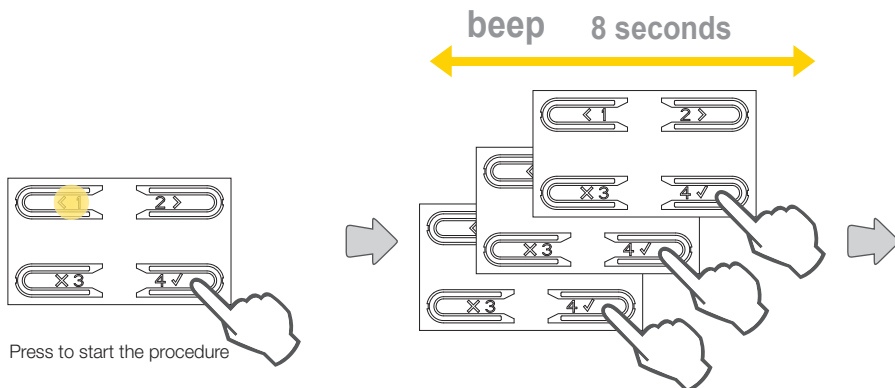

The Electronic unit emits a continuous tone for 8 seconds, press the push button 3 times before the end

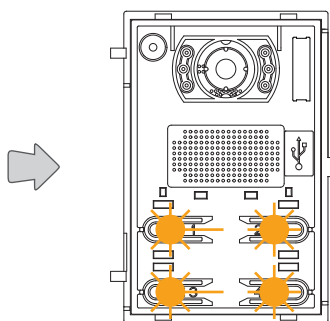

During reset, the push button LEDs flash

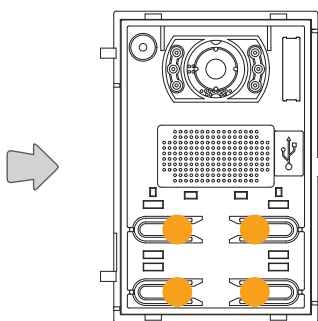

When the LEDs stop flashing, the reset procedure is complete

Restart entire system

Using this procedure, the Electronic unit sends a restart command to all the devices in the system in which it is installed, then it restarts itself too.

It is the functional equivalent to pressing the reset push button on previous generation Master Outdoor Stations.

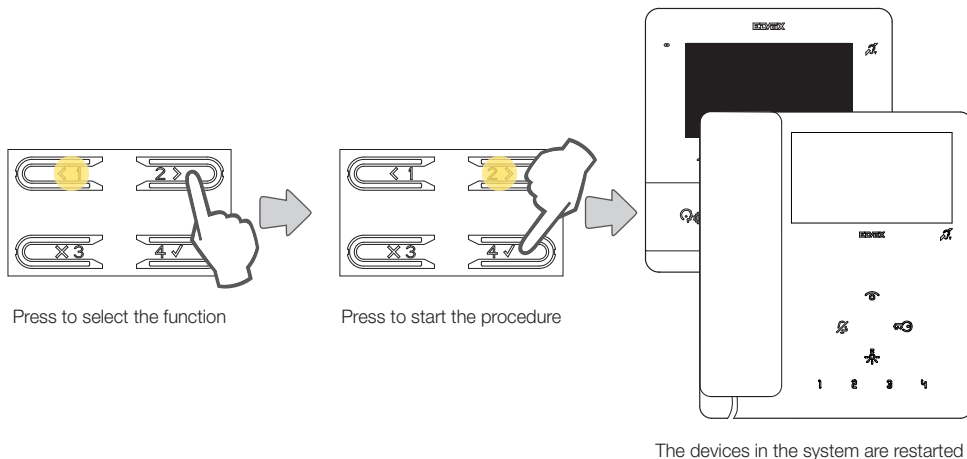

External memory reset

Use this procedure to delete any names in the Contacts List, entrance codes, push button remapping and logos.

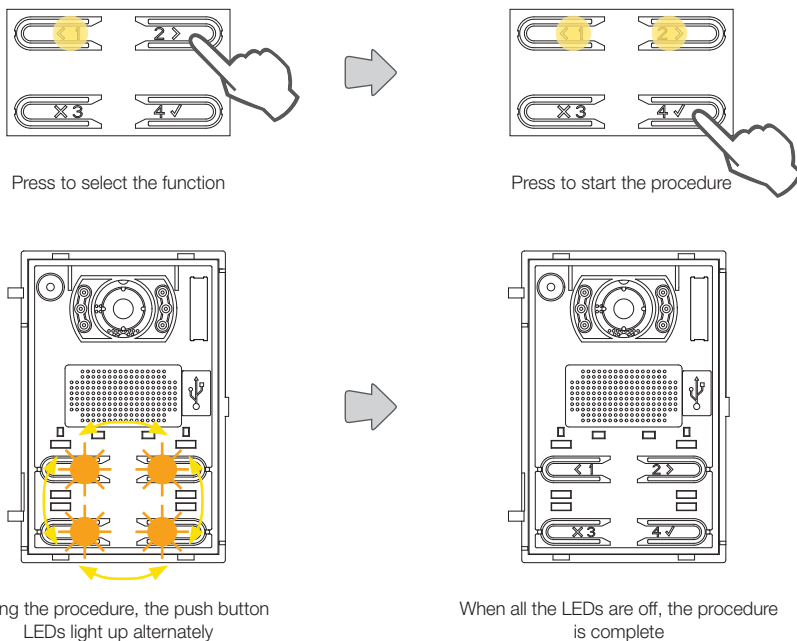

Setting push button behaviour according to the call button

In this section, you can define the behaviour of the Electronic unit push buttons according to the type of button installed.

Another 3 modes are possible:

- **2 push buttons** side-by-side are used to call 1 Indoor Station (default) using a single axial button 41110;
- **2 push buttons** side-by-side are used to call 2 Indoor Stations using a single rocker button 41111;
- **4 push buttons** are used to call 1 Indoor Station using a double axial button 41112.

Single rocker button

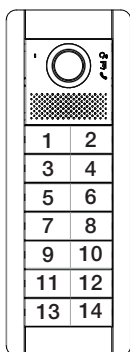

Single axial button
(default)

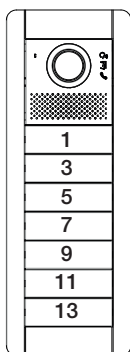

Double axial button

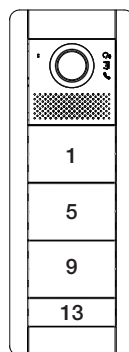

N.B.: for the 10 push button module Art. 41010, by selecting the double axial button mode, the last pair of push buttons is forced to single axial button

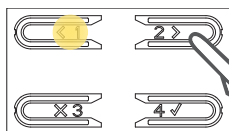

Press repeatedly, until the LEDs light up as in the previous section, to select the function.

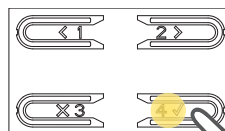

Press to confirm

The lit LED indicates the current setting

Setting for single rocker button 41111

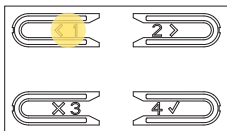

Setting for single axial button 41110 (default)

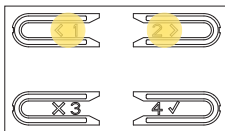

Setting for double axial button 41112

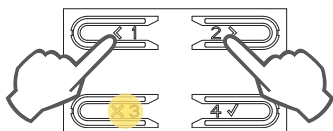
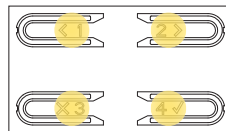

Press to select the previous option

Press to select the next option

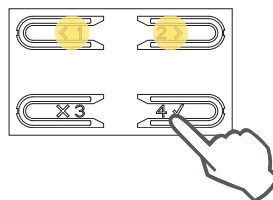

Press to confirm

With [SaveProg](#) you can change the grouping in a totally arbitrary way, except that the last line of each module cannot be configured as a double axial button.

The position chosen for the Indoor Stations, with skipped numbering, allows you not to have to encode the existing Indoor Stations again or to have to configure the existing Outdoor Stations again, if the grouping of the push buttons are changed at a later date either using this procedure or using [SaveProg](#)

 Camera enabling (only 41002)

In this section, you can enable/disable the additional camera connected to module 41002

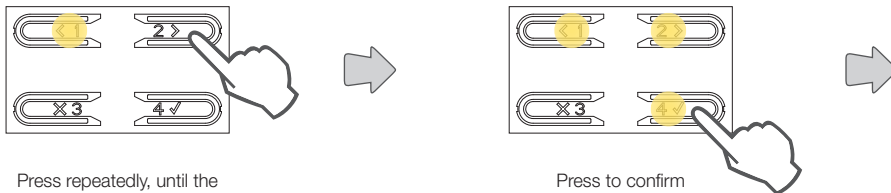

Press repeatedly, until the LEDs light up as in the previous section, to select the function.

Press to confirm

The lit LED indicates **the current setting**

Camera disabled
(default)

Camera enabled

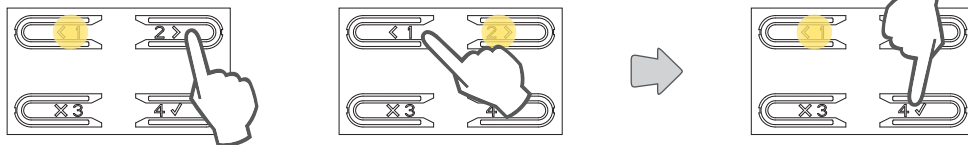

Press if necessary to amend the setting

Press to confirm

Common locks

On an outdoor station, the parameter allows the configuration of the lock opening in common with one or more outdoor stations.

Note: The function is available from firmware version 1.81 (also after update).

Configuration of common locks

Preliminary procedure

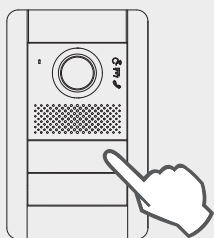

From the outdoor station whose lock opening you wish to share, make a call towards any indoor station installed on the same bus, where the outdoor station concerned by the programming is situated.
Then, from the indoor station, press the lock release button (this way the lock action control will be sent to the calling entrance panel, and the system will register the entrance panel to share).

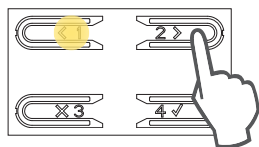

Press repeatedly, until the LEDs light up as in the previous section, to select the function.

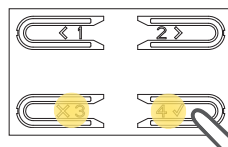

Press to confirm

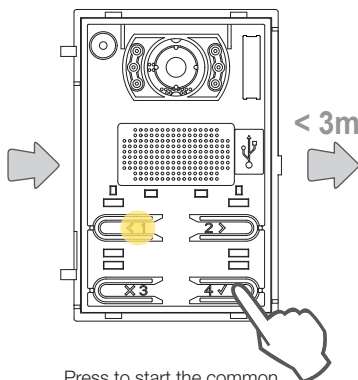

Press to start the common lock assignment procedure

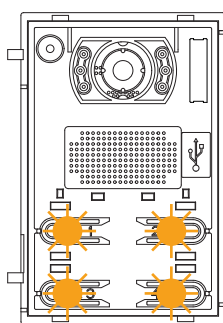

During configuration, the push button LEDs flash

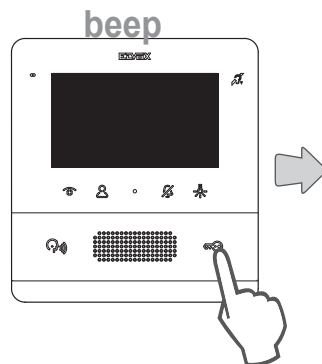

Press the lock release button on the indoor station called previously.

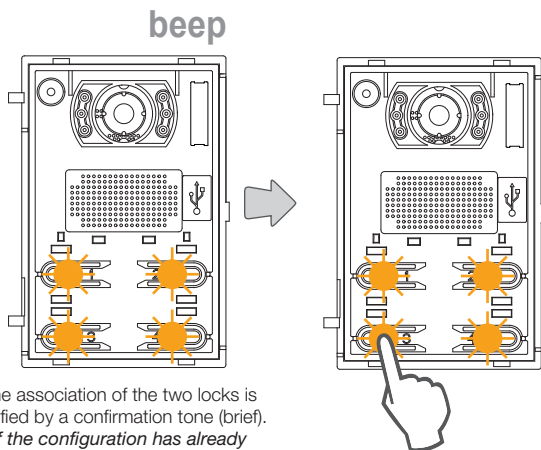

The association of the two locks is notified by a confirmation tone (brief).

If the configuration has already been acquired, the outdoor station emits a different (long) tone.

Press to exit. Alternatively, the outdoor station completes the procedure with a 3 minute timeout.

Notes:

The procedure for the association of the lock with the outdoor station described above can be repeated for a maximum of 8 other outdoor stations. Once this limit has been reached, the attempt at defining another association will fail and a tone will signal the error. Nevertheless, deleting the programming is possible, as described above below.

- The procedure will affect all the indoor stations and not just the one used for the definition of the association, and it also includes any reception switchboards (for a total of 204 devices). If the entrance panel is installed on a horizontal Bus, the procedure will affect all the indoor stations in the window (first ID - last ID) managed by the entrance panel itself.
- The outdoor station does not exit the configuration and does not go into busy mode if in the meantime the bus is used by a communication which has priority for the same outdoor unit; the red LEDs signal that the bus is not available and configuration continues.

Deletion of common locks configuration

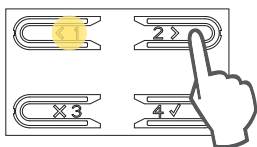

Press repeatedly, until the LEDs light up as in the previous section, to select the function.

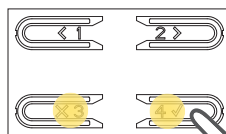

Press to confirm

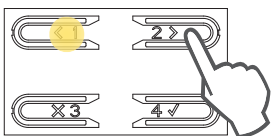

Press to delete the table of common locks from the outdoor station. This operation is confirmed by a dedicated tone.

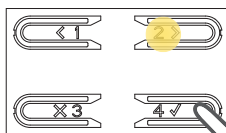

Press to confirm deletion.

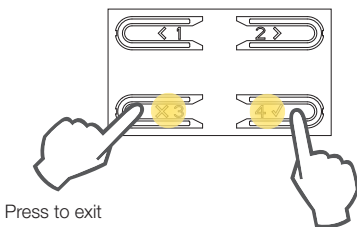

Press to exit programming

Press to continue with a new configuration of common locks

Advanced configuration with SaveProg software

Using [SaveProg](#), you can configure the electronic unit in an advanced manner.

[SaveProg](#) is PC software designed for advanced configuration of Due Fili Plus Systems.



494041265C0_MU_EN 02 2110



VIMAR

Viale Vicenza 14
36063 Marostica VI - Italy
www.vimar.com