









 IP 40 ... IP 67  
 -40°C ... +125°C | +250°C [MSD]

## US-M

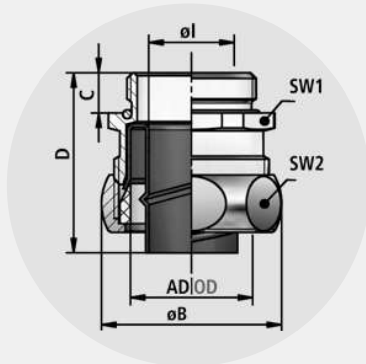

AD OD		FLEXA No.				FLEXA No.	
		FLEXAgraff®-AS FLEXAgraff®-VA				Kleine VPE Small packing units	
ø	Metr. EN 60423	[IP 40]	mm	øl mm	St. pcs.	[IP 40]	St. pcs.
10	M 10 x 1,0	1 5010 327 010	8 x 10	6,5	50	1 5010 827 010	10
14	M 12 x 1,5	1 5010 339 012	12 x 14	9,0	50	1 5010 839 012	10
17	M 16 x 1,5	1 5010 327 016	14 x 17	12,5	50	1 5010 827 016	10
21	M 20 x 1,5	1 5010 327 020	18 x 21	16,5	50	1 5010 827 020	10
27	M 25 x 1,5	1 5010 339 025	24 x 27	21,0	25	1 5010 839 025	10
36	M 32 x 1,5	1 5010 327 032	31 x 36	27,5	25	1 5010 827 032	2
45	M 40 x 1,5	1 5010 327 040	40 x 45	35,0	20	1 5010 827 040	2
56	M 50 x 1,5	1 5010 327 050	51 x 56	45,0	10	1 5010 827 050	2
56	M 63 x 1,5	1 5010 327 163	51 x 56	49,0	10	1 5010 827 163	2



AD OD		FLEXA No.			FLEXA No.			
		FLEXAgraff®-SI-ASF						
ø	Metr. EN 60423	[IP 67] * siehe Anzugsdrehmomente	mm	øl mm				St. pcs.
14	M 12 x 1,5	1 5010 337 012	10 x 14	9,0				50
17	M 16 x 1,5	1 5010 337 016	12 x 17	10,5				50
21	M 20 x 1,5	1 5010 335 020	16 x 21	14,5				50
27	M 25 x 1,5	1 5010 301 025	21 x 27	19,5				25
36	M 32 x 1,5	1 5010 337 032	27 x 36	25,5				25
45	M 40 x 1,5	1 5010 337 040	36 x 45	35,0				20
56	M 50 x 1,5	1 5010 337 050	47 x 56	45,0				10
56	M 63 x 1,5	1 5010 337 163	47 x 56	45,0				10

ø	Metr. EN 60423	[IP 40]	mm	øl mm	[IP 40]	mm	øl mm	St. pcs.
10	M 10 x 1,0	1 5011 328 010	7 x 10	6,0	1 5011 328 010	7 x 10	6,0	50
14	M 12 x 1,5	1 5011 327 012	11 x 14	9,0	1 5011 328 012	10 x 14	8,5	50
17	M 16 x 1,5	1 5011 328 016	13 x 17	11,5	1 5011 328 016	13 x 17	11,0	50
21	M 20 x 1,5	1 5011 328 020	17 x 21	16,0	1 5011 328 020	17 x 21	16,0	50
27	M 25 x 1,5	1 5011 340 025	23 x 27	21,0	1 5011 328 025	22 x 27	20,5	25
36	M 32 x 1,5	1 5011 328 032	29 x 36	27,5	1 5011 328 032	29 x 36	27,5	25
45	M 40 x 1,5	1 5011 328 040	38 x 45	35,0	1 5011 328 040	38 x 45	35,0	20
56	M 50 x 1,5	1 5011 328 050	49 x 56	45,0	1 5011 328 050	49 x 56	45,0	10
56	M 63 x 1,5	1 5011 328 163	49 x 56	47,0	1 5011 328 163	49 x 56	47,0	10

ø	Metr. EN 60423	[IP 54]	mm	øl mm	[IP 54]	mm	øl mm	St. Pcs.
14	M 12 x 1,5	1 5011 328 012	9 x 14	8,5	1 5011 328 012	9 x 14	8,5	50
17	M 16 x 1,5	1 5011 335 016	12 x 17	11,0	1 5011 335 016	12 x 17	11,0	50
21	M 20 x 1,5	1 5011 335 020	15 x 21	14,5	1 5011 335 020	16 x 21	14,5	50
27	M 25 x 1,5	1 5011 335 025	20 x 27	19,5	1 5011 301 025	21 x 27	19,5	25
36	M 32 x 1,5	1 5011 328 032	28 x 36	27,5	1 5011 337 032	28 x 36	27,5	25
45	M 40 x 1,5	1 5011 335 040	37 x 45	35,0	1 5011 335 040	37 x 45	35,0	20
56	M 50 x 1,5	1 5011 335 050	48 x 56	45,0	1 5011 335 050	48 x 56	45,0	10
56	M 63 x 1,5	1 5011 335 163	48 x 56	47,0	1 5011 335 163	48 x 56	47,0	10



VIDEO