



PRO+ QR18LED DIMMERABILE





QR18 LED DIMMERABILE



PRO+ Lista dimmers compatibili (QR18LED DIMMERABILE 18W)
 Dimmer compatibility list (QR18LED DIMMABLE 18W)



-I dimmers di tipo trailing-edge sono comunque preferibili al tipo leading-edge.

-Trailing-edge dimmers are definitely more suitable than leading-edge ones.

No.	Produttore Manufacturer	Modelli Models	Max lampadine(Pcs) Max bulbs(pcs)
1	ARDITI S.P.A	E488137	2
2	AURORA	EN-DSP400X	5
3	AURORA	AU-DSP400X	5
4	ALED	EasyDimmer 200	4
5	ALED	EasyDimmer 500	4
6	Bticino	MATIX AM5702	5
7	British General	DM400AP	4
8	Click	CMA145 MD9022	4
9	Danlers	DQD6DMK-400W	4
10	ELKO	315GLE	4
11	finder	15.51	2
12	finder	15.91	2
13	hager	GC1017	3
14	hager	GC3517	3
15	Hamilton	741 XLEDITB100	4
16	Hamilton	LITESTAT L400/2 VER02	5
17	Knightbridge	VFR200M	4
18	Legrand	67083	3
19	LIVOLO	2H24462A2	3
20	LONON	NB58T6	5
21	LK	506DA219	4
22	LK	FUGA LED250 TOUCH	4
23	MK	50074091-001	4
24	Orino	S707201	3
25	prime	NO.BRAS	5
26	RELCO	SNELLO LED T35	3
27	RELCO	RH SNELLO T35	3
28	RELCO	RM0540	3
29	RELCO	RTS34DLT	3
30	Rev	ET1 66012B	5
31	SAL	SDD400U	4
32	TECNEL	FLO7636M	3
33	TECNEL	TE44895B	2
34	TRANCIL	Dim-L13B	3
35	theben	DIMAX 544 PLUS	5
36	Unitec	30815	5
37	V-COM	1601260-2	3
38	VFR200M	Trailing Edge 2WAY-PUSH	3
39	VIKO	804040	5
40	VARILIGHT	JQP401W	4
41	Yokis	MTV500E	4
42	Zano	ZM0250	2



12°



30°



12°



30°

PRO+ QR18LED DIMMERABILE

F



Dimmerabile

18W EPISTAR LED	SDCM <3	CRI 97	PF 0,9	INSTANT	Dimmerabile
LME 0.96	SF 0.90	20000	Hg	GARANZIA ANNI 5	LONG LIFE 40000

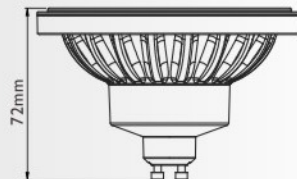
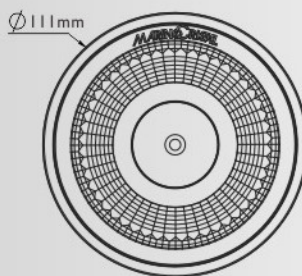

QR18LED DIMMERABILE

codice code	W W	W W	V V	attacco base	colore colour	lumen360°/cd lumen360°/cd	lumen90° lumen90°	fascio beam	imballo packing
21698	18	162(ERP)	220-240	GU10	2700°K	1500/10298	1320	12°	10/50
21700	18	167(ERP)	220-240	GU10	3000°K	1550/10813	1350	12°	10/50
21702	18	174(ERP)	220-240	GU10	4000°K	1600/11353	1400	12°	10/50

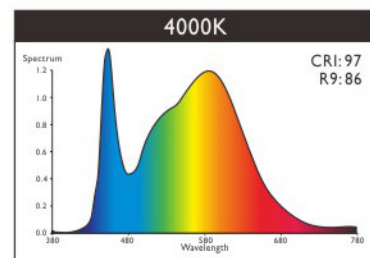
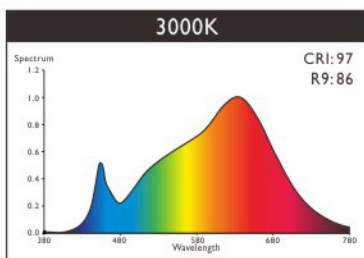
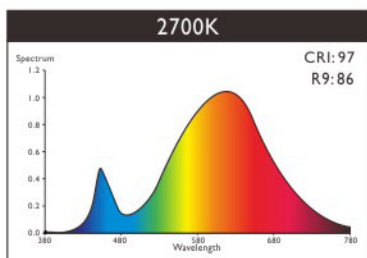

12°

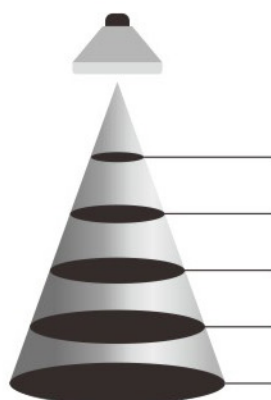
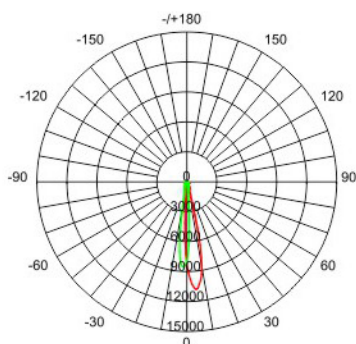

High	Diameter	Emax
1m	0.22 m	10690 lx
2m	0.42 m	2673 lx
3m	0.63 m	1188 lx
4m	0.84 m	668 lx
5m	1.05 m	427 lx

- Elevata qualità della luce e relativo comfort ambientale
- Eccellente compatibilità con i dimmers in commercio
- Range dimmerazione >80%
- L70B50_40000 ore
- Ottimo parametro deviazione temperatura colore(SDCM:<3)
- Alto indice di resa cromatica(CRI 97)
- Alto Indice rosso saturo(R9: 86)
- Ridottissimo effetto strobo(SVM:0.009)
- Privo di flicker visibile (AC ripple frequency <10%)
- Preciso controllo del fascio luminoso
- Garanzia 5 Anni

- High quality of light and relative ambient comfort
- Excellent dimming compatibility
- Dimming range >80%
- L70B50_40000 hrs
- Good Standard Deviation Colour Matching (SDCM:<3)
- High Colour Rendering Index (CRI 97)
- High saturated red colour index (R9:85)
- Very low strobo effect (SVM:0.009)
- Flicker free (AC ripple frequency <10%)
- Precise beam angle
- 5 YEARS Warranty



PRO+ QR18LED DIMMERABILE

F



Dimmerabile

18W EPISTAR LED	SDCM <3	CRI 97	PF 0,9	INSTANT	Dimmerabile
LMF 0.96	SF 0.90	20000	Hg	GARANZIA ANNI 5	LONG LIFE 40000

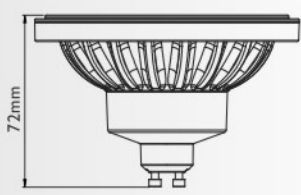
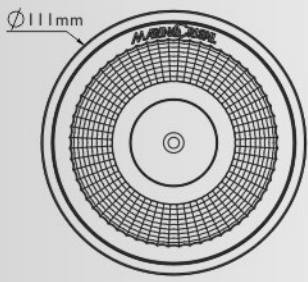

QR18LED DIMMERABILE

codice code	W W	W W	V V	attacco base	colore colour	lumen360°/cd lumen360°/cd	lumen90° lumen90°	fascio beam	imballo packing
21699	18	167(ERP)	220-240	GU10	2700°K	1550/3947	1350	30°	10/50
21701	18	174(ERP)	220-240	GU10	3000°K	1600/4145	1400	30°	10/50
21703	18	182(ERP)	220-240	GU10	4000°K	1650/4352	1450	30°	10/50

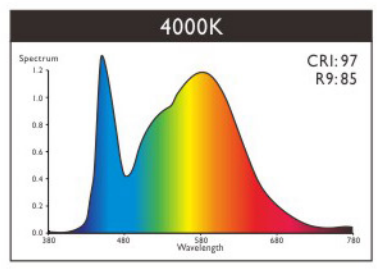
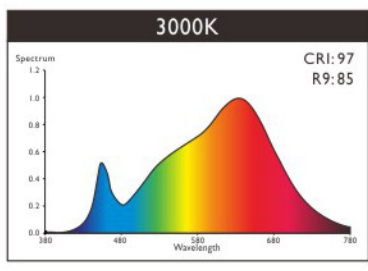
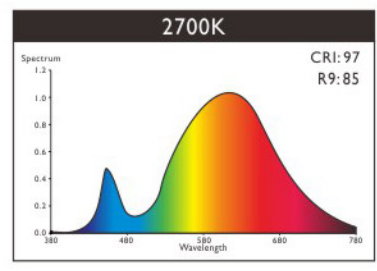

30°

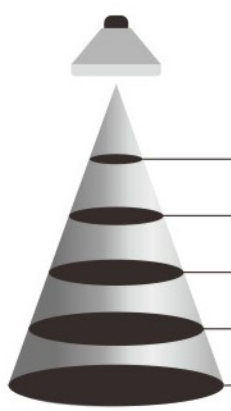
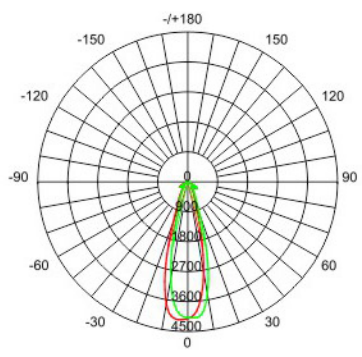

High	Diameter	Emax
1m	0.5 m	4125 lx
2m	1 m	1031 lx
3m	1.5 m	458 lx
4m	2m	257 lx
5m	2.5 m	165 lx

- Elevata qualità della luce e relativo comfort ambientale
- Eccellente compatibilità con i dimmers in commercio
- Range dimmerazione >80%
- L70B50_40000 ore
- Ottimo parametro deviazione temperatura colore(SDCM:<3)
- Alto indice di resa cromatica(CRI 97)
- Alto Indice rosso saturo(R9: 85)
- Ridottissimo effetto strobo(SVM: 0.009)
- Privo di flicker visibile (AC ripple frequency <10%)
- Preciso controllo del fascio luminoso
- Garanzia 5 Anni

- High quality of light and relative ambient comfort
- Excellent dimming compatibility
- Dimming range >80%
- L70B50_40000 hrs
- Good Standard Deviation Colour Matching (SDCM:<3)
- High Colour Rendering Index (CRI 97)
- High saturated red colour index (R9:85)
- Very low strobo effect (SVM: 0.009)
- Flicker free (AC ripple frequency <10%)
- Precise beam angle
- 5 YEARS Warranty