

TWS X



TWS X

Modulo / Module / Élément



Ghiera / Ring / Bague

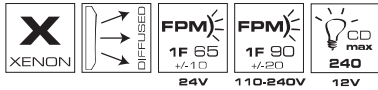

TWS X

V ACDC	24	-	-
V AC	-	110	240
mA	280	48	55

Codici / Codes

TWS X

Riferimenti pagina 159, paragrafo "TWS X"
See page 159, section "TWS X"
Voir page 159, section "TWS X"

Modulo con lampada a scarica di Xenon integrata. TWS X grazie al potente flash da 2J è ideale per richiamare l'attenzione nelle applicazioni a più alto rischio.

Tensione operativa

24V ACDC, 110V AC, 240V AC +/-10%

Caratteristiche meccaniche

Polycarbonato autoestingente ad alta resistenza agli impatti, adatto per utilizzo esterno grazie al grado di protezione IP66, UL TYPE 4X, garantito dalla doppia guarnizione in poliuretano presente su ogni modulo.

Caratteristiche luminose

Lente con rigatura verticale per una perfetta distribuzione della luce a 360° (effetto flash 2J).

Certificazioni / Certifications

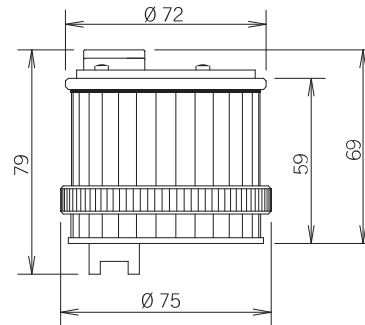

TWS X



Light module with integrated Xenon discharge lamp. TWS X, with the powerful 2J flash, is ideal for attracting attention in the most critical situations.

Voltages

24V ACDC, 110V AC, 240V AC +/-10%

Mechanical features

Self-extinguishing PC body with high impact resistance, suitable for outdoor use thanks to the IP66, UL TYPE 4X protection grade, guaranteed by a double polyurethane gasket on each module.

Optical features

The vertically lined lens allows a perfect light distribution over 360° (flashing effect 2J).



Élément lumineux avec lampe à décharge au Xénon intégrée. TWS X, grâce au puissant flash 2J, est idéal pour attirer l'attention dans les situations les plus critiques.

Tension d'utilisation

24V ACDC, 110V AC, 240V AC +/-10%

Caractéristiques mécaniques







Polycarbonate autoextinguible, haute résistance aux chocs, adapté pour une utilisation à l'extérieur grâce au degré de protection IP66, UL TYPE 4X, garanti par un double joint en polyuréthane sur chaque élément.

Caractéristiques optiques

La lentille striée en verticale permet une répartition parfaite de la lumière sur 360° (effet flash 2J).

TWS X

Modulo con lampada a scarica di Xenon / Light module with integrated Xenon discharge lamp / Élément lumineux avec tube à décharge au Xénon

						
24V ACDC	27731 27661	27732 27662	27733 27663	27734 27664	27735 27665	27736 27666
110V AC	27741 27671	27742 27672	27743 27673	27744 27674	27745 27675	27746 27676
240V AC	27751 27681	27752 27682	27753 27683	27754 27684	27755 27685	27756 27686

ACUSTICHE / SOUNDERS / ACOUSTIQUES**Modulo acustico piezoelettrico / Piezoelectric acoustic module / Élément acoustique piézoélectrique PZO**

		
12/48V ACDC	27718	27625
110/240V AC	27719	27628

Modulo acustico magnetodinamico / Magnetodynamic sounder / Élément acoustique magnétodynamique MDA

		
12/24V ACDC	27790	27794
48V AC	27791	27795
110V AC	27792	27796
240V AC	27793	27797

Modulo acustico magnetodinamico IP65 / Magnetodynamic sounder IP65 / Élément acoustique magnétodynamique IP65 A+

		
12/24V ACDC	33400	33402
110/240V AC	33401	33403

TWS HD

	SS	AL
CUSTODIA / ENCLOSURE / BOÎTIER (2) MODULI - MODULES - ELEMENTS	27602	27603
CUSTODIA / ENCLOSURE / BOÎTIER (3) MODULI - MODULES - ELEMENTS	27677	27840
CUSTODIA / ENCLOSURE / BOÎTIER (4) MODULI - MODULES - ELEMENTS	27606	27607

BASI TWS HD / TWS HD MOUNTERS / SUPPORTS TWS HD

Vendute separatamente, indispensabili per l'installazione
Sold separately, necessary for the installation
Vendus séparément, indispensables pour l'installation

	SS	AL
BASE PIANA / FLAT MOUNTER / BASE PLATE	27679	27841
BASE PALO / POLE MOUNTER / BASE TUBE	27678	27842
BASE LATERALE / SIDE MOUNTER / SUPPORT LATERAL	27680	27843

ACCESSORI / ACCESSORIES / ACCESSOIRES

		
BP1	27762	27693
BP2	27763	27694
SB	33357	33358
BS	27760	27691
KIT	27764	27695
PR	27761	27692
M16	27777	27778
KIT SS L10	27765	27845
KIT SS L20	27766	27846
KIT SS L40	27767	27847