

Technical Data Sheet

CODE 11136

MF 120/5" T LL

Wall axial fans



Certifications



IMQ Performance



TECHNICAL AND PERFORMANCE DATA

Absorbed Current max (A)	0,12	Voltage (V)	220-240
Absorbed Power max (W)	20	Weight (Kg)	0,62
Frequency (Hz)	50	Delivery max (l/s)	49
Insulation Class	II°	Delivery max (m³/h)	175
IP	X4	Pressure max (mmH2O)	5
Max ambient temperature for continuous operation (°C)	50	Pressure max (Pa)	49
Nominal Diameter (mm)	120	RPM	2150
		Sound Pressure level Lp [dB (A)] 3m	34,4

DIMENSIONS

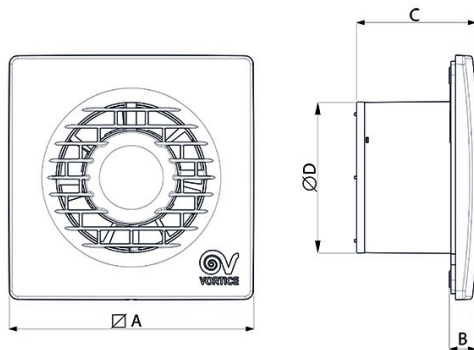

Size A (mm)	179
Size B (mm)	17
Size C (mm)	89
Size D (mm)	119

PER INFORMAZIONI:

Servizio al Cliente: tel +39 02 90699395 premendo 1 dopo messaggio registrato (consulenza su prodotti e impianti)

Pre & Post Vendita: fax +39 02 90699302

Email prevendita: prevendita@vortice-italy.com

Technical Data Sheet

CODE 11136

MF 120/5" T LL

Wall axial fans



DESCRIPTION

- Material: UV resistant plastic (prevents ageing caused by exposure to sunlight).
- Nominal diameter 120 mm.
- Motor protected against thermal overload, with shaft turning in ball bearings, coupled to screw type thermoplastic impeller with wing profile blades.
- Maximum air flow: 175 m³/h.
- Equipped with electronic timer designed to shut off the motor automatically after a set interval, selectable during installation in the range 3'-20' (default setting 3').
- Non-return damper fitted to outlet port.
- IMQ SAFETY and IMQ PERFORMANCE certifications.
- Vortice speed controller.

CURVES

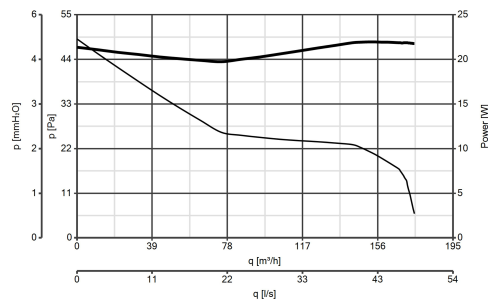

ACCESSORIES

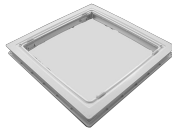

SF 120

Code 22163

PER INFORMAZIONI:

Servizio al Cliente: tel +39 02 90699395 premendo 1 dopo messaggio registrato (consulenza su prodotti e impianti)

Pre & Post Vendita: fax +39 02 90699302

Email prevendita: prevendita@vortice-italy.com