

Technical Data Sheet

CODE 15165

TORRETTA TRT 20 ED-V 4P

Centrifugal roof fans with vertical discharge for hot fumes extraction



Certifications

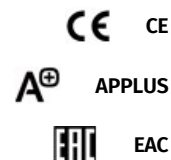

TECHNICAL AND PERFORMANCE DATA

Absorbed power 1st speed (W)	200	Weight (Kg)	61
Frequency (Hz)	50	Delivery 1st speed (l/s)	500
Insulation Class	I°	Delivery 1st speed (m³/h)	1800
Max ambient temperature for continuous operation (°C)	90	Max delivery at max speed (l/s)	611
Max. absorbed Current at max. speed (A)	0,50	Max delivery at max speed (m³/h)	2200
Max. absorbed Current at min. speed (A)	0,35	Pressure - 1st speed (mmH2O)	24
Max. absorbed power at max speed (W)	250	Pressure - 1st speed (Pa)	235
Motor IP protection	55	Pressure max - max speed (mmH2O)	34
Nominal Diameter (mm)	300	Pressure max - max speed (Pa)	334
Number of Phases (Ph)	3	RPM max	1420
Number of Poles	4	RPM min	1100
Voltage (V)	400	Sound Pressure level Lp [dB (A)] 3m	68

DIMENSIONS

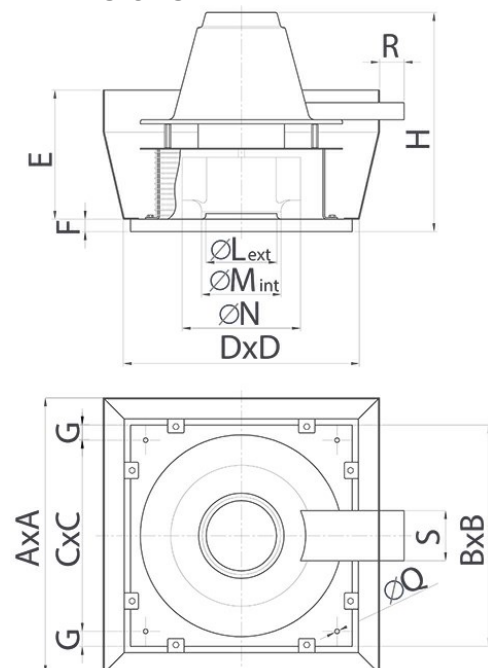

Dimensione Q (mm)	11
Dimensione R (mm)	40
Size A (mm)	907
Size B (mm)	550
Size C (mm)	500
Size D (mm)	580
Size E (mm)	432
Size F (mm)	38
Size G (mm)	25
Size H (mm)	653
Size L (mm)	231
Size M (mm)	236,5
Size N (mm)	359

PER INFORMAZIONI:

Servizio al Cliente: tel +39 02 90699395 premendo 1 dopo messaggio registrato (consulenza su prodotti e impianti)

Pre & Post Vendita: fax +39 02 90699302

Email prevendita: prevendita@vortice-italy.com

Technical Data Sheet

CODE 15165

TORRETTA TRT 20 ED-V 4P

Centrifugal roof fans with vertical discharge for hot fumes extraction



DESCRIPTION

- Centrifugal roof fan suitable for extracting hot fumes at up to 400 °C for 120 minutes.
- Base manufactured from phosphated pressed steel, epoxy powder coated with hammered effect finish, guaranteeing long-term resistance to atmospheric agents.
- Aerodynamically contoured inlet port for optimum performance, fashioned as a single unit with the base and gauged to optimize air flow.
- Motor mounting plate made of steel with galvanization surface treatment.
- Protective cap carried by top plate made of steel with galvanization surface treatment.
- Cold outside air drawn into a cooling chamber made of pressed steel with polyester powder coated and oven baked hammered effect finish, colour grey.
- Pressed steel motor cover: pickled and phosphated surface, polyester powder coated and oven baked finish, colour grey, with hammered texture.
- Accident prevention and anti-bird grilles (to UNI ISO 13857 standard), consisting of electrically welded steel rings with epoxy powder coated finish, colour black.
- Centrifugal impeller with self-cleaning backward curved blades, dynamically balanced (UNI ISO 1940, Point 1 – Class 6.3), made of electrolytically galvanized steel.
- Dahlander 2 speed three-phase AC motor with shaft turning in ball bearings, size to UNEL MEC standard, flange B5, self-ventilating. Motor insulation class H, with metal cooling fan and cable gland.
- Minimum air flow 1800 m³/h.
- Maximum air flow: 2200 m³/h.
- Galvanized steel eye lugs for transport and lifting/handling operations.
- Cable guaranteeing continuity of earth connection.
- Steel safety wire for anchoring appliances once installed.
- Vortice speed controller.

CURVES

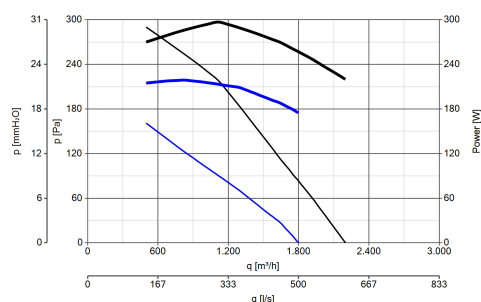

ACCESSORIES

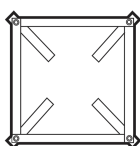

TR-CU 20/30/50
(CONTROTELAIO
DI BASE U)

Code 22512



TR-CVT
(COMMUTATORE
VELOCITA'
TRIF.)

Code 22910



IRT 15

Code 12923



IRET INVERTER
2,5 M

Code 12816

PER INFORMAZIONI:

Servizio al Cliente: tel +39 02 90699395 premendo 1 dopo messaggio registrato (consulenza su prodotti e impianti)

Pre & Post Vendita: fax +39 02 90699302

Email prevendita: prevendita@vortice-italy.com