

Technical Data Sheet

CODE 17153

LINEO 150 V0 ES

Energy saving mixed flow extractor fans



Certifications



TECHNICAL AND PERFORMANCE DATA

Frequency (Hz)	50	Delivery 1st speed (l/s)	14
Insulation Class	II°	Delivery 1st speed (m³/h)	50
IP	44	Max delivery at max speed (l/s)	167
Max ambient temperature for continuous operation (°C)	60	Max delivery at max speed (m³/h)	600
Nominal Current at max speed (A)	0,5	Pressure - 1st speed (mmH2O)	0,3
Nominal Current at min speed (A)	0,05	Pressure - 1st speed (Pa)	3
Nominal Diameter (mm)	150	Pressure max - max speed (mmH2O)	50
Nominal Power at max speed (W)	55	Pressure max - max speed (Pa)	490
Nominal Power at min speed (W)	3	RPM max	2550
Voltage (V)	220-240	RPM min	300
Weight (Kg)	2,2	Sound pressure level Lp in free field [dB(A)] 3 m max speed	53,2

DIMENSIONS

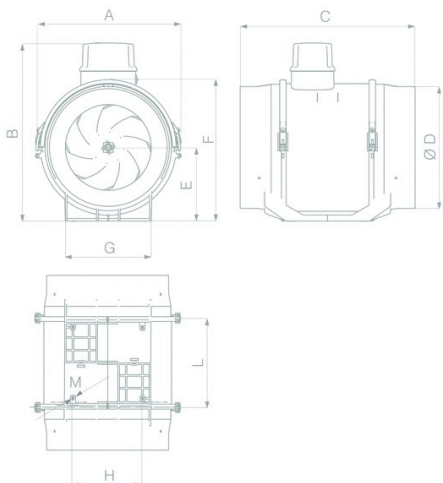

Size A (mm)	214,5
Size B (mm)	265
Size C (mm)	294
Size D (mm)	146
Size E (mm)	112,5
Size F (mm)	212
Size G (mm)	110
Size H (mm)	60
Size L (mm)	80
Size M (mm)	6

PER INFORMAZIONI:

Servizio al Cliente: tel +39 02 90699395 premendo 1 dopo messaggio registrato (consulenza su prodotti e impianti)

Pre & Post Vendita: fax +39 02 90699302

Email prevendita: prevendita@vortice-italy.com

Technical Data Sheet

CODE 17153

LINEO 150 V0 ES

Energy saving mixed flow extractor fans



DESCRIPTION

- Material: self-extinguishing plastic resin (self-extinguishing capability V0)
- Nominal diameter: 150 mm.
- High efficiency EC (brushless) motor, thermally insulated, with shaft on ball bearings, coupled to a mixed flow impeller.
- Cylindrical motor support equipped with straightens flow and integrating the wiring connection box with airtight lid.
- Possibility of connection to remote sensors.
- A dedicated dip-switch allows to choice:
 - o 2 speed product functioning, settable during the installation and adjustable through optional two-speed switch,
 - o 1 speed product functioning, adjustable through 0-10V signal potentiometer (supplied as optional).

CURVES

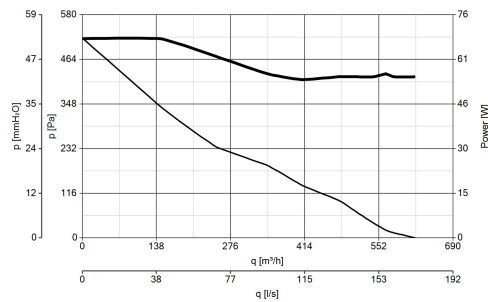

ACCESSORIES



POT-IT
Code 12826



POT
Code 12828



C PIR
Code 12998



C TIMER
Code 12999



PER INFORMAZIONI:

Servizio al Cliente: tel +39 02 90699395 premendo 1 dopo messaggio registrato (consulenza su prodotti e impianti)
Pre & Post Vendita: fax +39 02 90699302
Email prevendita: prevendita@vortice-italy.com