

VORT QBK COMFORT RANGE

Sound-proof double inlet cabinet fans

PRODUCT SPECIFICATIONS

Suitable for domestic, commercial and industrial applications: kitchens, bathrooms, offices, laboratories, factories, shops, laundry, restaurants, bars, theatres, ballrooms, etc.

LONG LIFE 30.000 h



- 10 models, 9 single phase e 1 three phase.
- Flow rates up to 8000 m³/h.
- Extruded UNI 9006 aluminium frames assembled with diecast aluminium joints.
- Zinc treated sandwich panels, sound-proof through mineral wool (density 90/100 Kg/m³) covered with 48 mm layer of fibreglass folse.
- Fan motor units with dynamically balanced twin intake direct feed forward-curved centrifugal blades, made using galvanized steel (ISO standard 1940).
- 1-speed induction motors, all in class F except code 45287 which is in class B, with shafts turning in ball bearings and suitable for control with electronic variable voltage or auto-transformer devices.
- 1 inspection panel with locking handle.
- 1 intake panel with smooth round nipple.
- 1 smooth round nipple on inlet vent.
- Operating temperature between -20 and +50°C.
- Protection rating: IP20.
- Insulation class: Cl.I ⊕.

Fans used in VORT QBK COMFORT range comply with ErP N° 327/2011/UE.

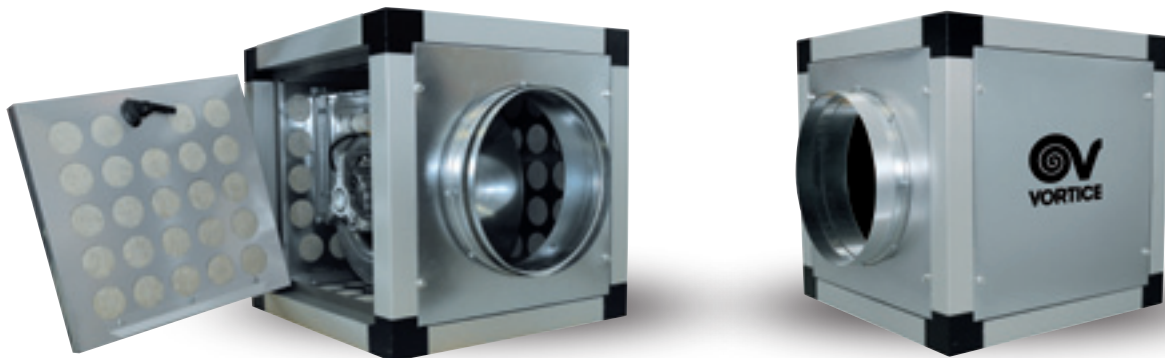



KEY FEATURES

- Low noise emissions.
- Compact size.
- Designed for application in ventilation duct.
- High performances and reduced maintenance needs.
- Flexible installation thanks to being able to adapt the air delivery side to the system requirements by appropriately varying the arrangement of the removable panels of the enclosure depending on the needs of the system.

TECHNICAL DATA

Models	Code	V ~ Hz	W nom/max	A max	Poles	RPM min/max	Max Airflow		Max Pressure		°C Max	IP motor	Kg
							m³/h min/max	l/s min/max	mmH ₂ O min/max	Pa min/max			
VORT QBK COMFORT 500 4V	45288	230~50	nd* 140	0.62	6	1030	610	169	42.3	415	50	20	18
VORT QBK COMFORT 800 MC/H 4V	45250		163 290	1.28		595 1600	315 910	87 253	38.7 51.0	380 500			24.45
VORT QBK COMFORT 1000	45280	230~50/60	90 181	0.80	2	1650	547	152	35.7	350	40	54	32
VORT QBK COMFORT 7/7 4M 1V	45281	230~50	200 450	2.00	4	1260	1890	525	30.0	295			50
VORT QBK COMFORT 9/9 6M 1V	45282		250 500	2.2	6	800	2900	805	18.8	185	40	42	
VORT QBK COMFORT 9/9 4M 1V	45283		550 1110	4.70	4	1290	3420	947	41.9	411	50	51	
VORT QBK COMFORT 10/10 6M 1V	45284	230~50/60	315 640	2.90	6	600	3700	1028	26.0	255	50	10	56
VORT QBK COMFORT 10/10 4M 1V	45285	230~50	600 2200	9.70	4	1400	5148	1426	57.5	564			50
VORT QBK COMFORT 12/12 6M 1V	45286		400~50	735 1890	8.20	6	735	5600	1551	42.0	411	40	20
VORT QBK COMFORT 12/12 6T 1V	45287	1100 2455		4.30	900		8000	2216	33.6	330	50		



SERIE VORT QBK COMFORT

Sound-proof double inlet cabinet fans

SOUND LEVELS

Models	Code	Speed	125 Hz	250 Hz	500 Hz	1000 Hz	2000 Hz	4000 Hz	8000 Hz	Lw dB (A)	Lp dB (A) 1m*
VORT QBK COMFORT 500 4V	45288	4 - max	29.2	32.2	38.0	39.5	33.0	12.6	<10	43.0	35.0
		3	21.3	24.7	30.8	29.8	24.6	34.6		26.6	
		2	15.1	19.4	26.3	24.0	17.6	29.3		21.3	
		1 - min	10.8	14.4	19.7	16.1	10.1	22.7		14.7	
VORT QBK COMFORT 800 MC/H 4V	45250	4 - max	46.3	52.3	54.6	51.2	47.1	29.1	20.4	58.5	50.4
		3	44.1	45.9	48.8	46.4	41.5	23.1	13.9	53.0	45.0
		2	38.3	39.3	42.1	40.3	34.1	14.8	<10	46.5	38.5
		1 - min	28.4	30.3	35.0	31.8	25.3	<10		38.3	30.3
VORT QBK COMFORT 1000	45280	1	26.3	32.2	39.3	42.7	38.9	17.7	7.2	45.7	37.7
VORT QBK COMFORT 7/7 4M 1V	45281		33.5	42.4	48.2	53.3	51.5	30.9	20.1	56.5	48.4
VORT QBK COMFORT 9/9 6M 1V	45282		37.3	47.9	49.7	53.1	51.7	34.8	18.2	57.1	49.1
VORT QBK COMFORT 9/9 4M 1V	45283		41.4	54.6	55.0	60.0	59.3	41.5	29.1	64.0	55.9
VORT QBK COMFORT 10/10 6M 1V	45284		37.78	51.1	50.7	53.8	52.7	34.2	18.8	58.3	50.3
VORT QBK COMFORT 10/10 4M 1V	45285		44.0	50.8	53.3	57.4	55.7	35.4	22.9	64.0	56.7
VORT QBK COMFORT 12/12 6M 1V	45286		49.0	53.4	61.5	59.6	58.3	38.0	24.1	68.2	60.2
VORT QBK COMFORT 12/12 6T 1V	45287		49.8		65.5	61.9	60.4	42.3	29.2	71.2	63.1

*Sound pressure level measured at 1 m in free field conditions with long-cased appliance in delivery mode, in accordance with standard EN ISO 3741.

DIMENSIONS

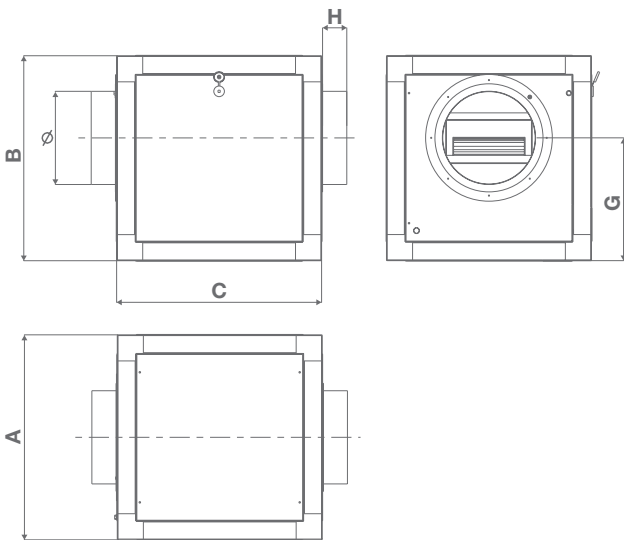

Models	A	B	C	G	H	Ø
VORT QBK COMFORT 500 4V	400	230	230	45	200	200
VORT QBK COMFORT 800 MC/H 4V						
VORT QBK COMFORT 1000	550	330	330	65	250	250
VORT QBK COMFORT 7/7 4M 1V						
VORT QBK COMFORT 9/9 6M 1V						
VORT QBK COMFORT 9/9 4M 1V	650	417.5	417.5	60	315	250
VORT QBK COMFORT 10/10 6M 1V						
VORT QBK COMFORT 10/10 4M 1V						
VORT QBK COMFORT 12/12 6M 1V						
VORT QBK COMFORT 12/12 6T 1V	750	450	450	90	450	450

Dimensions (mm)



ACCESSORIES

	Description	Code	Product	
	IREM 3 - Single-phase speed controller	12931	45280 - 45281 - 45284	
	IREM 5 - Single-phase speed controller	12932	45283	
	IREM 9 - Single-phase speed controller	12933	45285 - 45286	
	IRET 6 - Three-phase speed controller	12934	45287	
	C4VM16 - Three-phase speed controller	14021	45288 - 45250	
	QBK RRC COMFORT - Rain guard	7/7 - 9/9	24212	45280 - 45281
		10/10	24213	45283 - 45284 - 45285
		12/12	24214	45286 - 45287
	QBK F - Feet	24247	for all models	

APPLICATIONS





VORT QBK COMFORT RANGE

Sound-proof double inlet cabinet fans

PERFORMANCE CURVES

— Max — Min

VORT QBK COMFORT 500 4V

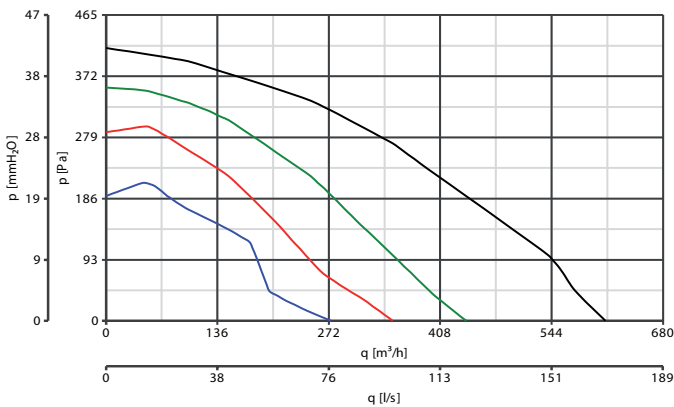

VORT QBK COMFORT 800 MC/HV 4V

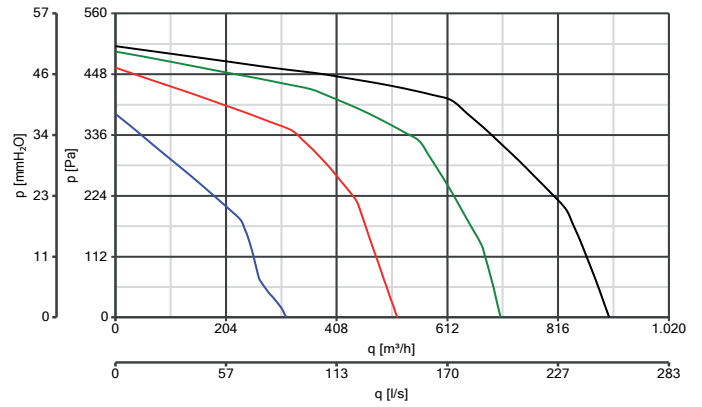

— p= delivery

VORT QBK COMFORT 1000

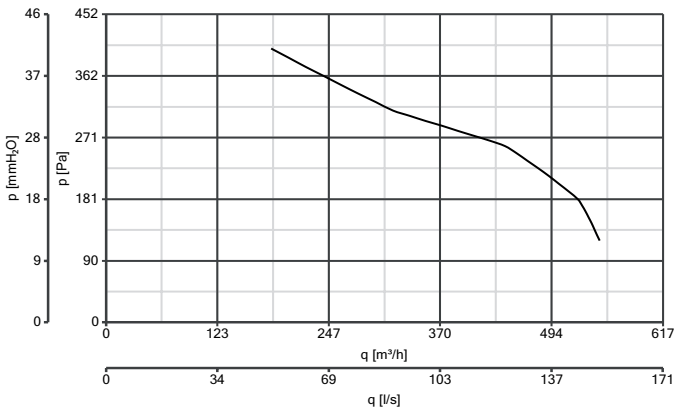

VORT QBK COMFORT 7/7 4M 1V

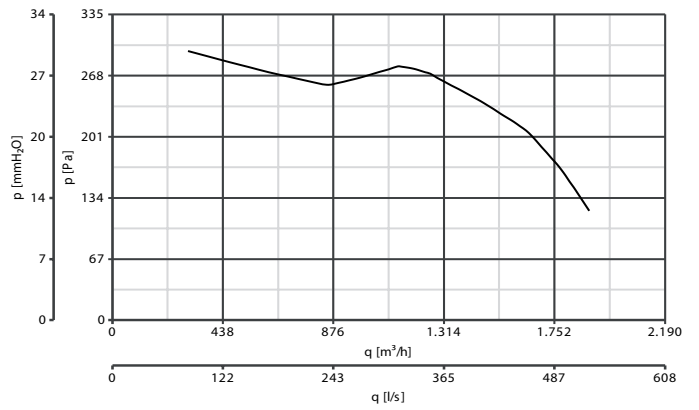

VORT QBK COMFORT 9/9 4M 1V

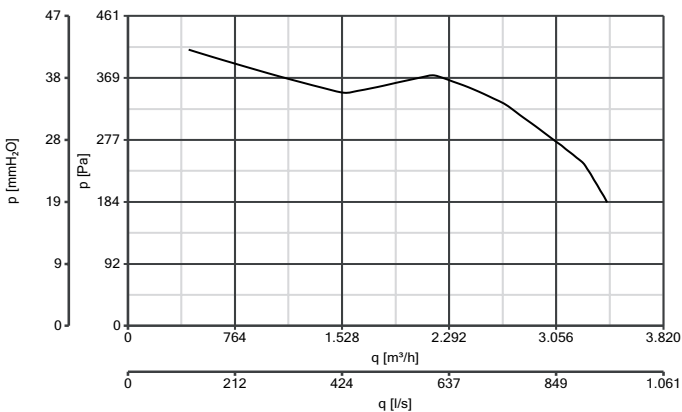

VORT QBK COMFORT 9/9 6M 1V

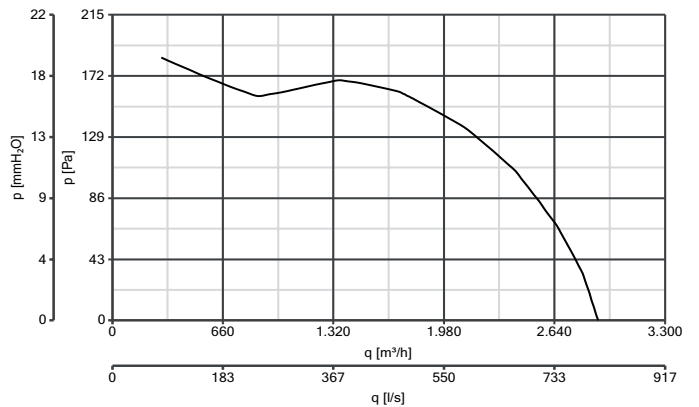



PERFORMANCE CURVES

— p= delivery

VORT QBK COMFORT 10/10 6M 1V

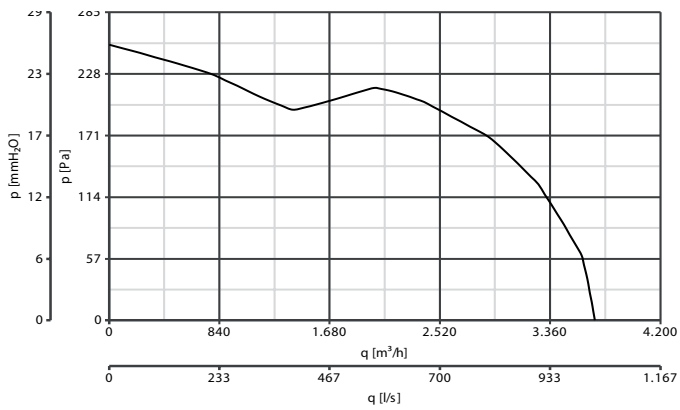

VORT QBK COMFORT 10/10 4M 1V

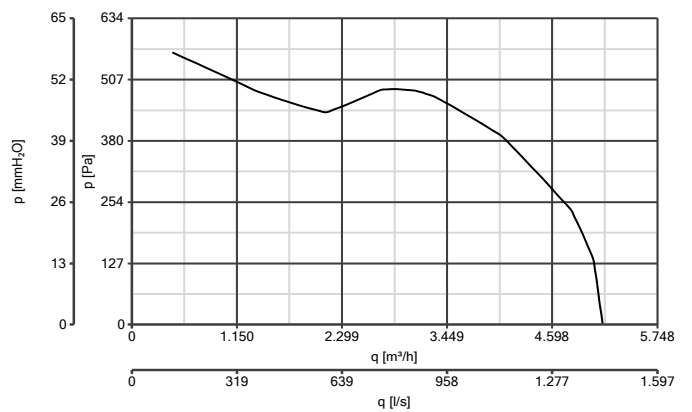

VORT QBK COMFORT 12/12 6M 1V

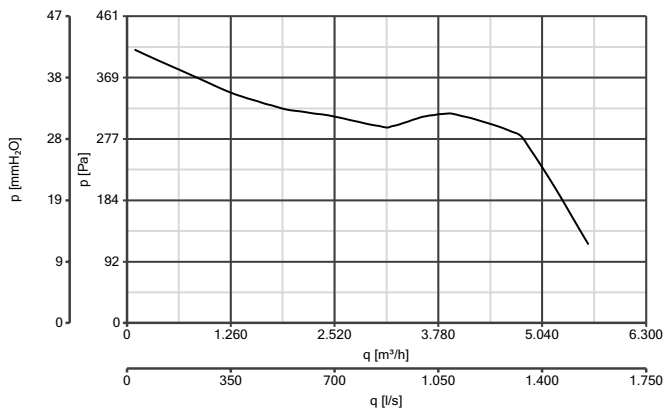

VORT QBK COMFORT 12/12 6T 1V

