

LED LINE SMD W2  
COMFORT GEN. 2  
L07/14/28/50/56



LED LINE SMD W2  
COMFORT GEN. 2  
L07/14/28/50/56  
– 700 lm, 1400 lm

**WU-M-666, WU-M-667, WU-M-668, WU-M-669,  
WU-M-670, WU-M-671, WU-M-672, WU-M-673**

**Typical Applications**

Built-in luminaires/general illumination

- Office lighting
- Retail, corridor and shelf lighting
- T5/T8 replacement as built-in module
- Furniture lighting

**LED Line SMD W2 Comfort Gen. 2  
L07/14/28/50/56**

- **LONG SERVICE LIFE TIME: 72,000 H (L80, B10)**
- **HIGHLY EFFICIENT: UP TO 195 LM/W  
AT T<sub>p</sub> = 50 °C**
- **5 LENGTHS AVAILABLE: 70 / 140 / 280 /  
500 / 560 MM**
- **2 DIFFERENT LUMEN PACKAGES**
- **ZHAGA-COMPLIANT DIMENSIONS  
(EXCEPT L07, L50)**

# LED Line SMD W2 Comfort Gen. 2 L07/14/28/50/56

## Technical Notes

- LED built-in module for integration into luminaires
- Dimensions
  - WU-M-666: 70x20 mm
  - WU-M-667/668: 140x20 mm
  - WU-M-669/670: 280x20 mm
  - WU-M-673: 500x20 mm
  - WU-M-671/672: 560x20 mm
- Driving current: 250 mA / 350 mA / 500 mA / 600 mA / 700 mA
- On-board push-in terminals, optional on top or bottom
- Beam angle: 120°

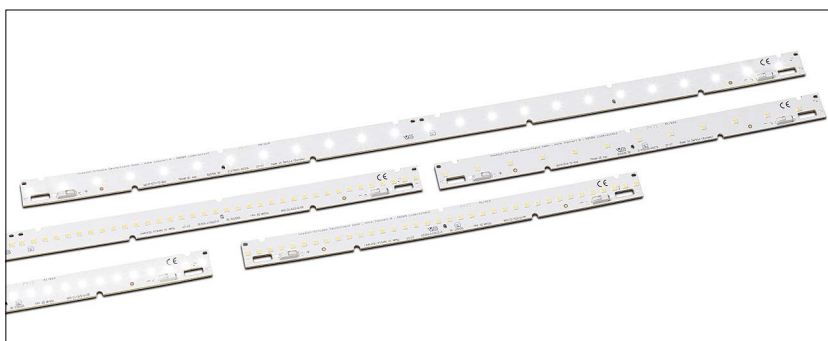

## Typical Light Distribution Curve

Data are available in .ldt format for download under [www.vossloh-schwabe.com](http://www.vossloh-schwabe.com).

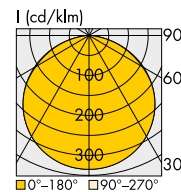

## Covers and W2 optics

Please visit our homepage for details for suitable covers and W2 optics:

- [www.vossloh-schwabe.com/en/products/optics-reflectors/linear-covers/linear-covers-1r-for-led-line-smd-w2-pcb/](http://www.vossloh-schwabe.com/en/products/optics-reflectors/linear-covers/linear-covers-1r-for-led-line-smd-w2-pcb/)
- [www.vossloh-schwabe.com/en/products/optics-reflectors/linear-optics/linear-optics-1r-for-led-line-smd-w2-pcb/](http://www.vossloh-schwabe.com/en/products/optics-reflectors/linear-optics/linear-optics-1r-for-led-line-smd-w2-pcb/)

## Electrical Characteristics

at  $t_p = 50\text{ °C}$

Type	No. of SMDs	Typ. voltage DC					Temperature coefficient mV/K	Typ. power consumption				
		250 mA V	350 mA V	500 mA V	600 mA V	700 mA V		250 mA W	350 mA W	500 mA W	600 mA W	700 mA W
<b>LED Line SMD W2 Comfort Gen. 2 – L07</b>												
WU-M-666	6	5.4	5.6	5.8	5.9	6	-2.23	1.4	2	2.9	3.6	4.2
<b>LED Line SMD W2 Comfort Gen. 2 – L14</b>												
WU-M-667	6	5.4	5.6	5.8	5.9	6	-2.23	1.4	2	2.9	3.6	4.2
WU-M-668	12	10.9	11.2	11.7	11.9	12.1	-4.45	2.7	3.9	5.8	7.1	8.4
<b>LED Line SMD W2 Comfort Gen. 2 – L28</b>												
WU-M-669	12	10.9	11.2	11.7	11.9	12.1	-4.45	2.7	3.9	5.8	7.1	8.4
WU-M-670	24	21.8	22.4	23.3	23.7	24.1	-8.90	5.4	7.8	11.7	14.2	16.9
<b>LED Line SMD W2 Comfort Gen. 2 – L50</b>												
WU-M-673	42	38.1	39.2	40.8	41.5	42.2	-15.58	9.5	13.7	20.4	24.9	29.6
<b>LED Line SMD W2 Comfort Gen. 2 – L56</b>												
WU-M-671	24	21.8	22.4	23.3	23.7	24.1	-8.90	5.4	7.8	11.7	14.2	16.9
WU-M-672	48	43.5	44.7	46.6	47.4	48.3	-17.81	10.9	15.7	23.3	28.5	33.8

Voltage and power consumption tolerance: ± 10% | **Use of external LED constant current driver required.**

## Maximum Ratings

Exceeding the maximum ratings can lead to reduction of service life or destruction of the module.

Type	Operating current [mA]	Operation temperature range at $t_c$ point		Storage temperature range		Max. allowed repetitive peak current for frequencies $\geq 100$ Hz [mA]
		°C min.	°C max.	°C min.	°C max.	
All types	700	-20	+80	-20	+85	900

## Operating Life

L80/B10

in hours at measured temperature at  $t_p$  point

	250 mA			350 mA			500 mA			600 mA			700 mA		
	40 °C	50 °C	80 °C	40 °C	50 °C	80 °C	40 °C	50 °C	80 °C	40 °C	50 °C	80 °C	40 °C	50 °C	80 °C
All types	> 72,000	> 72,000	> 55,000	> 72,000	> 72,000	> 54,000	> 72,000	> 72,000	> 51,000	> 54,000	> 54,000	> 50,000	> 36,000	> 36,000	> 36,000

The values contained in this data sheet can change due to technical innovations. Any such changes will be made without separate notification.



# LED Line SMD W2 Comfort Gen. 2 – L07/14/28/50/56

## Optical Characteristics – CRI > 80

at  $t_p = 50\text{ }^\circ\text{C}$

CRI:  $R_a > 80$

Type	Ref. No. Connection			Colour	Correlated colour temp.* K	Typ. luminous flux** and typ. efficiency** at										Photometric code	
	top (TC)	bottom (BC)	top (STC)			250 mA	350 mA	500 mA	600 mA	700 mA	500 mA	600, 700 mA					
<b>LED Line SMD W2 Comfort Gen. 2 – L07</b>																	
WU-M--666-TC/STC-830	<b>570726</b>	—	on request	WW	3000	250	185	350	178	490	168	580	163	665	157	830/349	
WU-M--666-TC/STC-840	<b>570727</b>	—	on request	NW	4000	265	195	370	188	520	178	615	172	705	167	840/349	
WU-M--666-TC/STC-850	<b>571453</b>	—	on request	CW	5000	265	195	370	188	520	178	615	172	705	167	850/349	
WU-M--666-TC/STC-865	<b>571454</b>	—	on request	CW	6500	260	191	360	184	505	173	600	168	685	162	865/349 /359	
<b>LED Line SMD W2 Comfort Gen. 2 – L14</b>																	
WU-M--667-TC/BC/STC-827	<b>571842</b>	on request	on request	WW	2700	245	179	340	173	475	163	565	158	645	153	827/349	
WU-M--667-TC/BC/STC-830	<b>570728</b>	on request	on request	WW	3000	250	185	350	178	490	168	580	163	665	157	830/349	
WU-M--667-TC/BC/STC-840	<b>570729</b>	on request	on request	NW	4000	265	195	370	188	520	178	615	172	705	167	840/349	
WU-M--667-TC/BC/STC-850	<b>570730</b>	on request	on request	CW	5000	265	195	370	188	520	178	615	172	705	167	850/349	
WU-M--667-TC/BC/STC-865	<b>570731</b>	on request	on request	CW	6500	260	191	360	184	505	173	600	168	685	162	865/349 /359	
WU-M--668-TC/BC/STC-827	<b>572553</b>	on request	on request	WW	2700	490	179	675	173	950	163	1125	158	1290	153	827/349	
WU-M--668-TC/BC/STC-830	<b>570732</b>	on request	on request	WW	3000	505	185	695	178	980	168	1160	163	1330	157	830/349	
WU-M--668-TC/BC/STC-835	<b>573052</b>	on request	on request	WW	3500	510	187	705	180	990	170	1175	165	1345	159	835/349	
WU-M--668-TC/BC/STC-840	<b>570733</b>	on request	on request	NW	4000	530	195	735	188	1035	178	1225	172	1405	167	840/349	
WU-M--668-TC/BC/STC-850	<b>570734</b>	on request	on request	CW	5000	530	195	735	188	1035	178	1225	172	1405	167	850/349	
WU-M--668-TC/BC/STC-865	<b>570735</b>	<b>571455</b>	on request	CW	6500	520	191	720	184	1010	173	1195	168	1370	162	865/349 /359	
<b>LED Line SMD W2 Comfort Gen. 2 – L28</b>																	
WU-M--669-TC/BC/STC-827	<b>571843</b>	on request	on request	WW	2700	490	179	675	173	950	163	1125	158	1290	153	827/349	
WU-M--669-TC/BC/STC-830	<b>570736</b>	<b>570773</b>	<b>570753</b>	WW	3000	505	185	695	178	980	168	1160	163	1330	157	830/349	
WU-M--669-TC/BC/STC-840	<b>570737</b>	<b>570774</b>	<b>570754</b>	NW	4000	530	195	735	188	1035	178	1225	172	1405	167	840/349	
WU-M--669-TC/BC/STC-850	<b>570738</b>	<b>570775</b>	<b>570755</b>	CW	5000	530	195	735	188	1035	178	1225	172	1405	167	850/349	
WU-M--669-TC/BC/STC-865	<b>570739</b>	<b>570776</b>	<b>570756</b>	CW	6500	520	191	720	184	1010	173	1195	168	1370	162	865/349 /359	
WU-M--670-TC/BC/STC-827	<b>571745</b>	on request	on request	WW	2700	975	179	1355	173	1905	163	2255	158	2585	153	827/349	
WU-M--670-TC/BC/STC-830	<b>570740</b>	<b>570777</b>	<b>570757</b>	WW	3000	1005	185	1395	178	1960	168	2320	163	2660	157	830/349	
WU-M--670-TC/BC/STC-835	<b>573076</b>	on request	on request	NW	3500	1015	187	1410	180	1980	170	2345	165	2690	159	835/349	
WU-M--670-TC/BC/STC-840	<b>570741</b>	<b>570778</b>	<b>570758</b>	NW	4000	1065	195	1475	188	2070	178	2455	172	2810	167	840/349	
WU-M--670-TC/BC/STC-850	<b>570742</b>	<b>570779</b>	<b>570759</b>	CW	5000	1065	195	1475	188	2070	178	2455	172	2810	167	850/349	
WU-M--670-TC/BC/STC-865	<b>570743</b>	<b>570780</b>	<b>570760</b>	CW	6500	1035	191	1440	184	2020	173	2390	168	2745	162	865/349 /359	
<b>LED Line SMD W2 Comfort Gen. 2 – L50</b>																	
WU-M--673-TC/BC/STC-830	on request	on request	<b>570769</b>	WW	3000	1760	185	2440	178	3430	168	4060	163	4655	157	830/349	
WU-M--673-TC/BC/STC-840	<b>570752</b>	<b>570789</b>	<b>570770</b>	NW	4000	1860	195	2580	188	3625	178	4290	172	4920	167	840/349	
WU-M--673-TC/BC/STC-850	on request	on request	<b>570771</b>	CW	5000	1860	195	2580	188	3625	178	4290	172	4920	167	850/349	
WU-M--673-TC/BC/STC-865	on request	on request	<b>570772</b>	CW	6500	1815	191	2515	184	3535	173	4185	168	4800	162	865/349 /359	
<b>LED Line SMD W2 Comfort Gen. 2 – L56</b>																	
WU-M--671-TC/BC/STC-827	<b>571844</b>	on request	on request	WW	2700	975	179	1355	173	1905	163	2255	158	2585	153	827/349	
WU-M--671-TC/BC/STC-830	<b>570744</b>	<b>570781</b>	<b>570761</b>	WW	3000	1005	185	1395	178	1960	168	2320	163	2660	157	830/349	
WU-M--671-TC/BC/STC-840	<b>570745</b>	<b>570782</b>	<b>570762</b>	NW	4000	1065	195	1475	188	2070	178	2455	172	2810	167	840/349	
WU-M--671-TC/BC/STC-850	<b>570746</b>	<b>570783</b>	<b>570763</b>	CW	5000	1065	195	1475	188	2070	178	2455	172	2810	167	850/349	
WU-M--671-TC/BC/STC-865	<b>570747</b>	<b>570784</b>	<b>570764</b>	CW	6500	1035	191	1440	184	2020	173	2390	168	2745	162	865/349 /359	
WU-M--672-TC/BC/STC-827	<b>571744</b>	on request	on request	WW	2700	1955	179	2710	173	3805	163	4505	158	5165	153	827/349	
WU-M--672-TC/BC/STC-830	<b>570748</b>	<b>570785</b>	<b>570765</b>	WW	3000	2010	185	2790	178	3920	168	4640	163	5320	157	830/349	
WU-M--672-TC/BC/STC-835	<b>573075</b>	on request	on request	NW	3500	2035	187	2820	180	3965	170	4690	165	5380	159	835/349	
WU-M--672-TC/BC/STC-840	<b>570749</b>	<b>570786</b>	<b>570766</b>	NW	4000	2125	195	2950	188	4145	178	4905	172	5625	167	840/349	
WU-M--672-TC/BC/STC-850	<b>570750</b>	<b>570787</b>	<b>570767</b>	CW	5000	2125	195	2950	188	4145	178	4905	172	5625	167	850/349	
WU-M--672-TC/BC/STC-865	<b>570751</b>	<b>570788</b>	<b>570768</b>	CW	6500	2075	191	2875	184	4045	173	4785	168	5485	162	865/349 /359	

3000 K = warm white (WW), 4000 K = neutral white (NW), 5000 K and 6500 K = cool white (CW)

\* Colour tolerance: 3 MacAdam | \*\* Production tolerance of luminous flux and efficiency:  $\pm 10\%$

### Minimum order quantity (packaging unit)

L07 (TC/STC)	L14 (BC)	L14 (TC/STC)	L50 (BC)	L28 / L56 (TC/STC/BC)	L50 (TC/STC)
120 pcs.	48 pcs.	48 pcs.	75 pcs.	24 pcs.	330 pcs.

The values contained in this data sheet can change due to technical innovations. Any such changes will be made without separate notification.



# LED Line SMD W2 Comfort Gen. 2 – L07/14/28/50/56

## Optical Characteristics – CRI > 90

at  $t_p = 50\text{ °C}$

CRI:  $R_a > 90$

Type	Ref. No. Connection			Colour	Correlated colour temp.* K	Typ. luminous flux** and typ. efficiency** at												Photometric code		
	top (TC)	bottom (BC)	top (STC)			250 mA		350 mA		500 mA		600 mA		700 mA		250, 350, 500 mA	600, 700 mA			
						lm	lm/W	lm	lm/W	lm	lm/W	lm	lm/W	lm	lm/W					

### LED Line SMD W2 Comfort Gen. 2 – L07

WU-M--666-TC/STC-930	on request	—	—	WW	3000	215	158	295	152	415	143	495	140	565	134	930/349
WU-M--666-TC/STC-940	on request	—	—	NW	4000	225	165	310	159	435	150	515	145	595	140	940/349
WU-M--666-TC/STC-950	on request	—	—	CW	5000	225	165	310	159	435	150	515	145	595	140	950/349
WU-M--666-TC/STC-965	on request	—	—	CW	6500	215	158	300	153	420	144	495	140	570	135	965/349 /359

### LED Line SMD W2 Comfort Gen. 2 – L14

WU-M--667-TC/BC/STC-930	on request	on request	on request	WW	3000	215	158	295	152	415	143	495	140	565	134	930/349
WU-M--667-TC/BC/STC-940	on request	on request	on request	NW	4000	225	165	310	159	435	150	515	145	595	140	940/349
WU-M--667-TC/BC/STC-950	on request	on request	on request	CW	5000	225	165	310	159	435	150	515	145	595	140	950/349
WU-M--667-TC/BC/STC-965	on request	on request	on request	CW	6500	215	158	300	153	420	144	495	140	570	135	965/349 /359
WU-M--668-TC/BC/STC-930	<b>570790</b>	on request	on request	WW	3000	430	158	595	152	835	143	985	139	1130	134	930/349
WU-M--668-TC/BC/STC-940	<b>570791</b>	on request	on request	NW	4000	450	165	620	159	875	150	1035	145	1185	140	940/349
WU-M--668-TC/BC/STC-950	on request	on request	on request	CW	5000	450	165	620	159	875	150	1035	145	1185	140	950/349
WU-M--668-TC/BC/STC-965	on request	on request	on request	CW	6500	430	158	600	153	840	144	995	140	1140	135	965/349 /359

### LED Line SMD W2 Comfort Gen. 2 – L28

WU-M--669-TC/BC/STC-930	<b>570792</b>	on request	<b>572345</b>	WW	3000	430	158	595	152	835	143	985	139	1130	134	930/349
WU-M--669-TC/BC/STC-940	<b>570793</b>	<b>570814</b>	<b>572346</b>	NW	4000	450	165	620	159	875	150	1035	145	1185	140	940/349
WU-M--669-TC/BC/STC-950	<b>570794</b>	on request	on request	CW	5000	450	165	620	159	875	150	1035	145	1185	140	950/349
WU-M--669-TC/BC/STC-965	<b>570795</b>	on request	on request	CW	6500	430	158	600	153	840	144	995	140	1140	135	965/349 /359
WU-M--670-TC/BC/STC-930	<b>570796</b>	<b>570815</b>	<b>570808</b>	WW	3000	855	157	1185	152	1670	143	1975	139	2265	134	930/349
WU-M--670-TC/BC/STC-935	on request	on request	<b>571829</b>	WW	3500	855	157	1185	152	1670	143	1975	139	2265	134	935/349
WU-M--670-TC/BC/STC-940	<b>570797</b>	<b>570816</b>	<b>570809</b>	NW	4000	895	165	1245	159	1745	150	2070	145	2370	140	940/349
WU-M--670-TC/BC/STC-950	<b>570798</b>	on request	on request	CW	5000	895	165	1245	159	1745	150	2070	145	2370	140	950/349
WU-M--670-TC/BC/STC-965	<b>570799</b>	on request	on request	CW	6500	860	158	1195	153	1680	144	1990	140	2280	135	965/349 /359

### LED Line SMD W2 Comfort Gen. 2 – L50

WU-M--673-TC/BC/STC-930	on request	on request	<b>570812</b>	WW	3000	1500	157	2080	152	2920	143	3455	139	3960	134	930/349
WU-M--673-TC/BC/STC-940	on request	on request	<b>570813</b>	NW	4000	1570	165	2175	159	3055	150	3620	145	4150	140	940/349
WU-M--673-TC/BC/STC-950	on request	on request	on request	CW	5000	1570	165	2175	159	3055	150	3620	145	4150	140	950/349
WU-M--673-TC/BC/STC-965	on request	on request	on request	CW	6500	1510	158	2090	153	2940	144	3480	140	3990	135	965/349 /359

### LED Line SMD W2 Comfort Gen. 2 – L56

WU-M--671-TC/BC/STC-930	<b>570800</b>	on request	<b>572343</b>	WW	3000	855	157	1185	152	1670	143	1975	139	2265	134	930/349
WU-M--671-TC/BC/STC-940	<b>570801</b>	<b>570817</b>	<b>572344</b>	NW	4000	895	165	1245	159	1745	150	2070	145	2370	140	940/349
WU-M--671-TC/BC/STC-950	<b>570802</b>	on request	on request	CW	5000	895	165	1245	159	1745	150	2070	145	2370	140	950/349
WU-M--671-TC/BC/STC-965	<b>570803</b>	on request	on request	CW	6500	860	158	1195	153	1680	144	1990	140	2280	135	965/349 /359
WU-M--672-TC/BC/STC-930	<b>570804</b>	<b>570818</b>	<b>570810</b>	WW	3000	1715	157	2375	152	3335	143	3950	139	4530	134	930/349
WU-M--672-TC/BC/STC-935	on request	on request	<b>571830</b>	WW	3500	1715	157	2375	152	3335	143	3950	139	4530	134	935/349
WU-M--672-TC/BC/STC-940	<b>570805</b>	<b>570819</b>	<b>570811</b>	NW	4000	1795	165	2485	159	3495	150	4135	145	4740	140	940/349
WU-M--672-TC/BC/STC-950	<b>570806</b>	on request	on request	CW	5000	1795	165	2485	159	3495	150	4135	145	4740	140	950/349
WU-M--672-TC/BC/STC-965	<b>570807</b>	on request	on request	CW	6500	1725	158	2390	153	3360	144	3975	140	4560	135	965/349 /359

3000 K = warm white (WW), 4000 K = neutral white (NW), 5000 K and 6500 K = cool white (CW)

\* Colour tolerance: 3 MacAdam | \*\* Production tolerance of luminous flux and efficiency:  $\pm 10\%$

### Minimum order quantity (packaging unit)

L07 (TC/STC)	L14 (BC)	L14 (TC/STC)	L50 (BC)	L28 / L56 (TC/STC/BC)	L50 (TC/STC)
120 pcs.	48 pcs.	48 pcs.	75 pcs.	24 pcs.	330 pcs.

The values contained in this data sheet can change due to technical innovations. Any such changes will be made without separate notification.

## Mechanical Dimensions

**TC = Top Connection**  
**BC = Bottom Connection**  
**STC = Small Top Connection**

### WU-M-666-TC

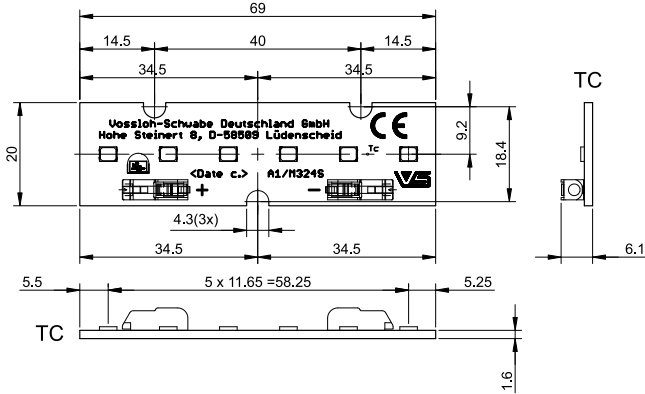

### WU-M-666-STC

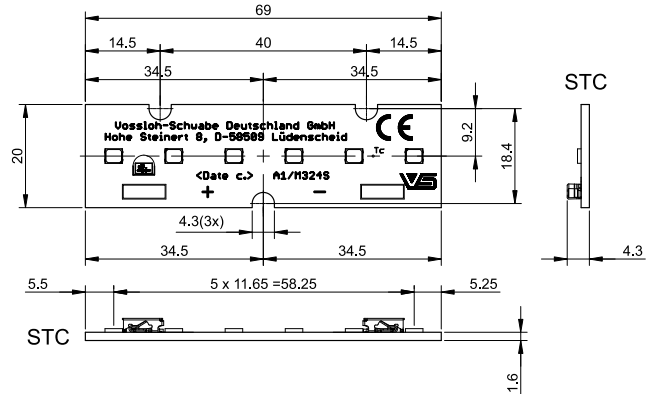

### WU-M-667-BC/TC

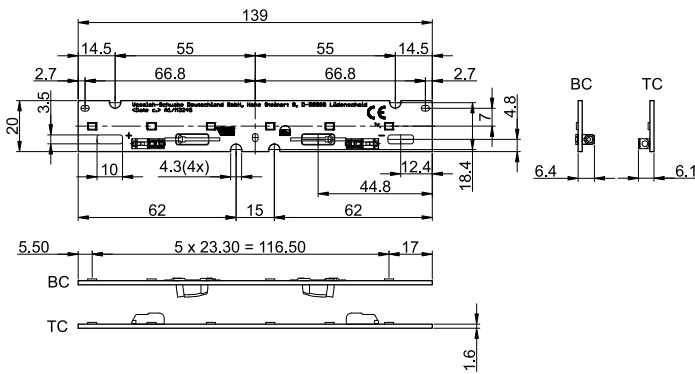

### WU-M-667-STC

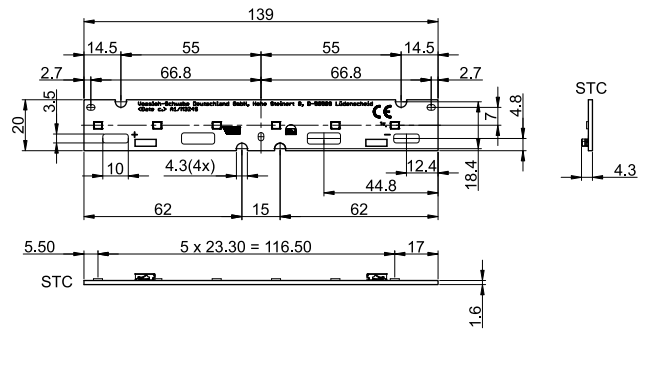

### WU-M-668-BC/TC

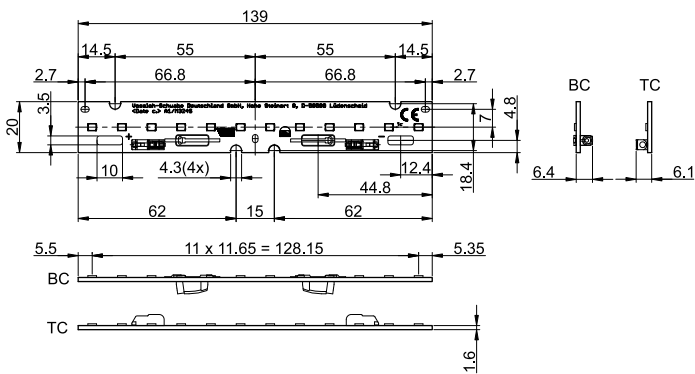

### WU-M-668-STC

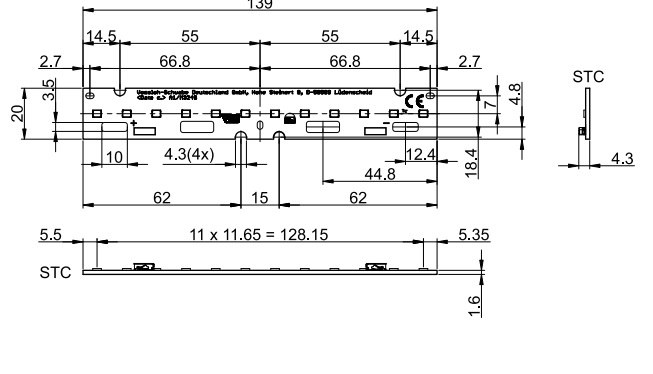

The values contained in this data sheet can change due to technical innovations. Any such changes will be made without separate notification.

## Mechanical Dimensions

**TC = Top Connection**  
**BC = Bottom Connection**  
**STC = Small Top Connection**

### WU-M-669-BC/TC

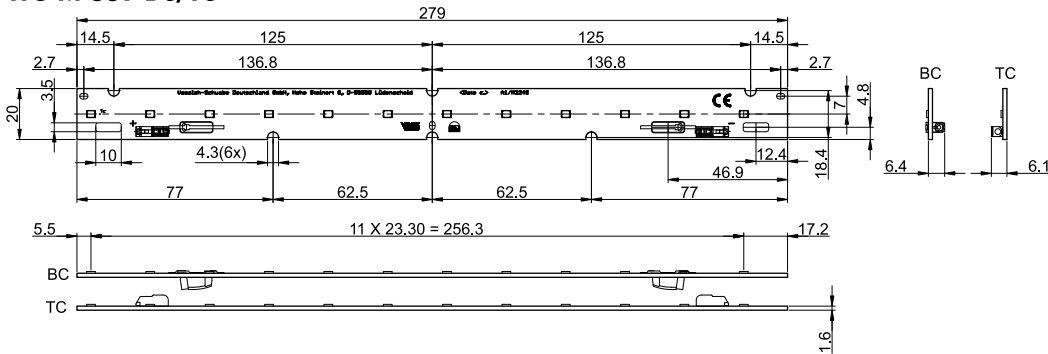

### WU-M-669-STC

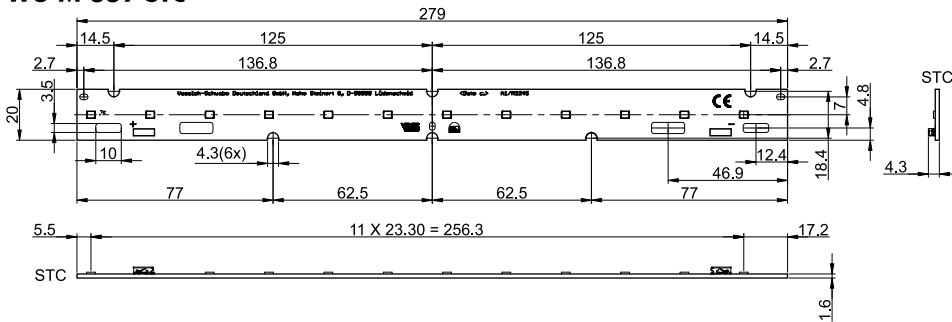

### WU-M-670-BC/TC

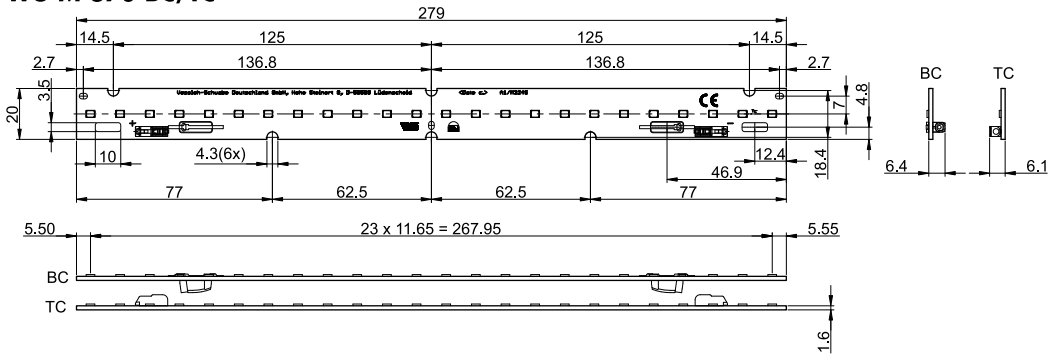

### WU-M-670-STC

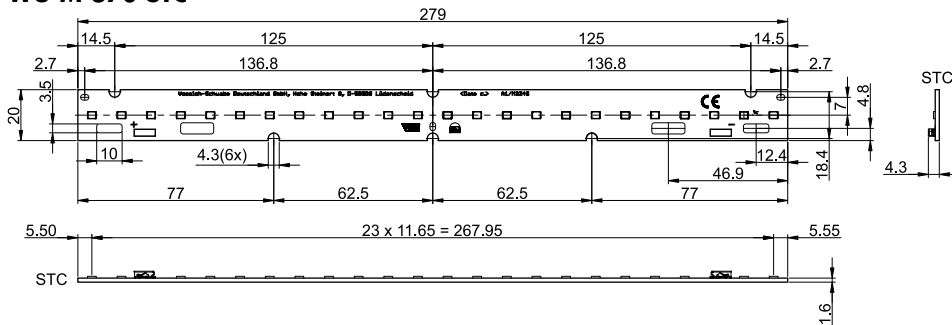

The values contained in this data sheet can change due to technical innovations. Any such changes will be made without separate notification.

## Mechanical Dimensions

### WU-M-671-BC/TC

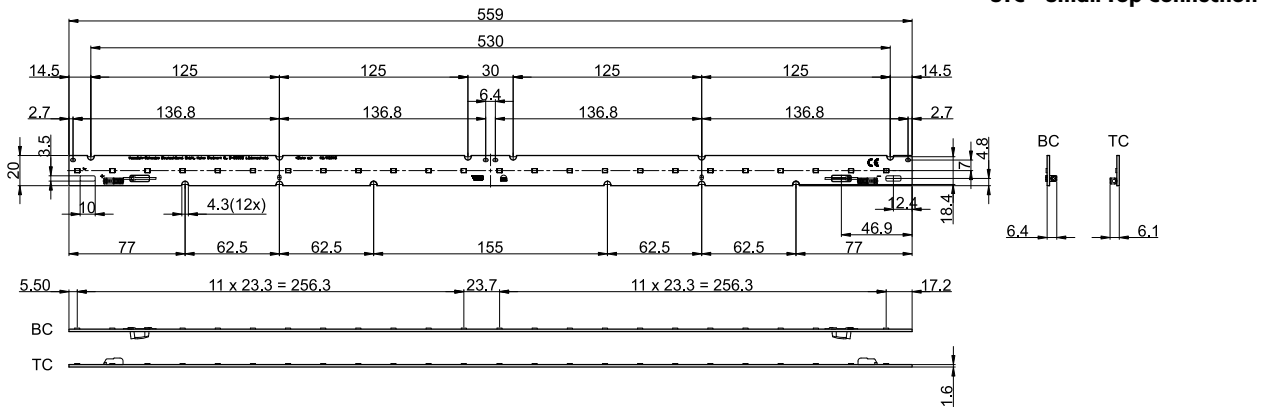

### WU-M-671-STC

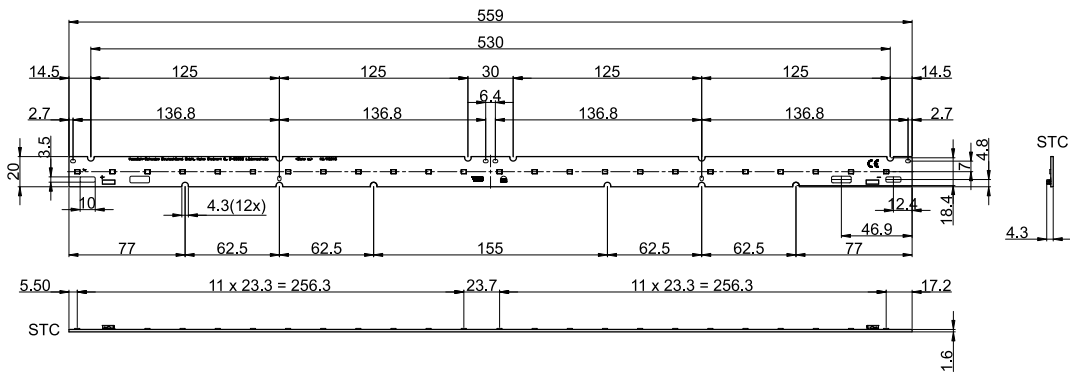

### WU-M-672-BC/TC

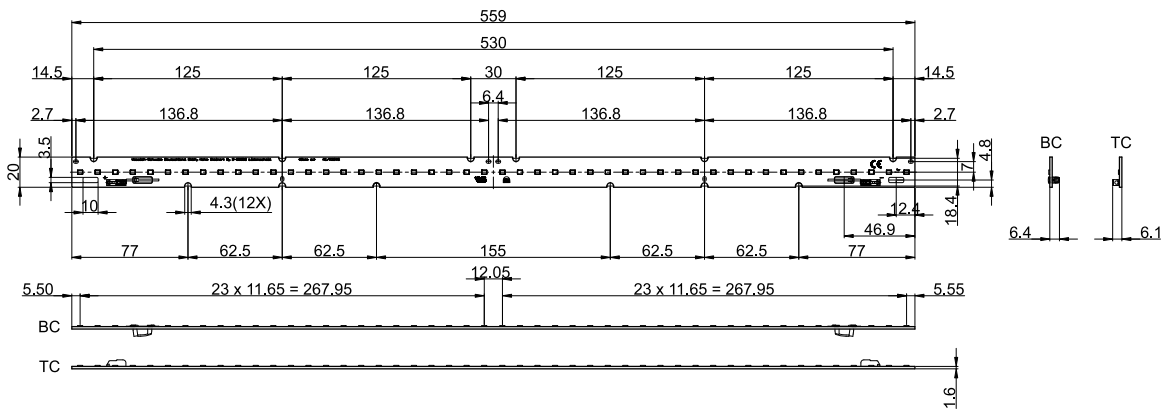

### WU-M-672-STC

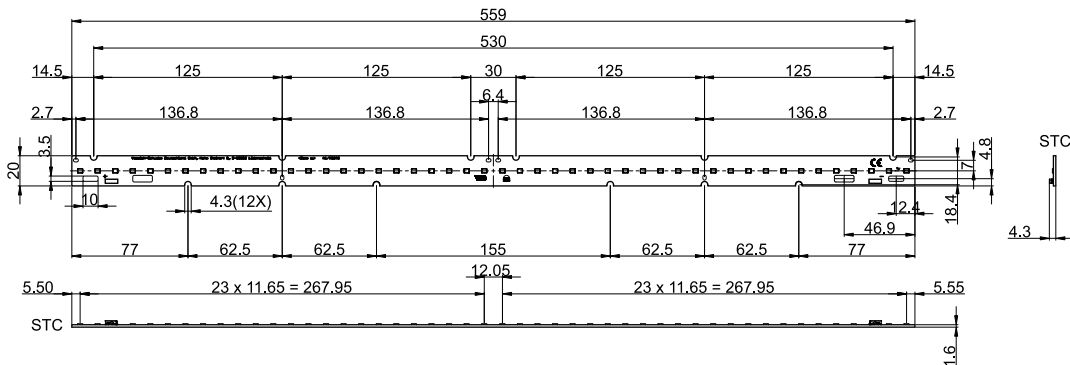

The values contained in this data sheet can change due to technical innovations. Any such changes will be made without separate notification.

## Mechanical Dimensions

### WU-M-673-BC/TC

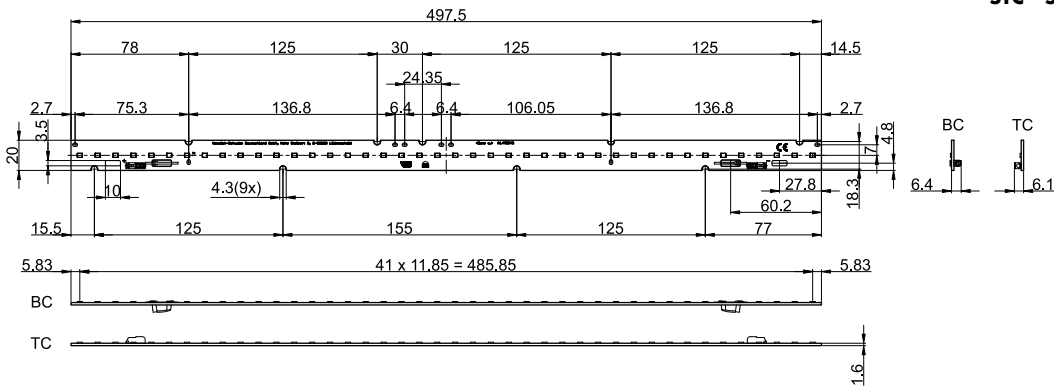

**TC = Top Connection**  
**BC = Bottom Connection**  
**STC = Small Top Connection**

### WU-M-673-STC

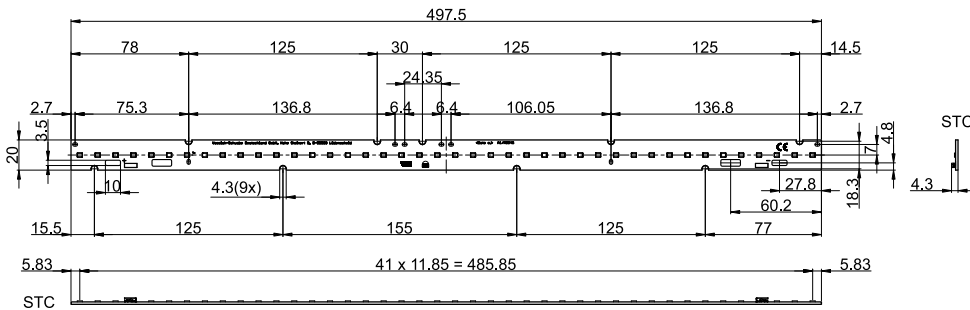

## Connection Example

- The number of modules that can be connected in series depends on the available output voltage of the LED driver.
- The clearance and creepage distances are designed for working voltages up to 350 V DC (basic insulation) and 185 V DC (reinforced insulation).
- In case of assembly of the LED modules in profiles (e.g. aluminium) where the profile touches the top edge of the PCB the clearance and creepage distances are reduced to 175 V DC (basic insulation) and 50 V DC (reinforced insulation).
- Max. diameter of screw head (M4):  $\varnothing$  8 mm
- Only the marked holes  are fixing holes for screws M4. Please do not use other holes for fixation!

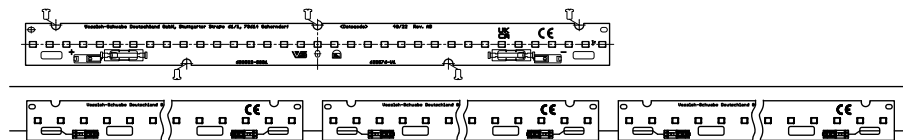

The values contained in this data sheet can change due to technical innovations. Any such changes will be made without separate notification.



## Bins

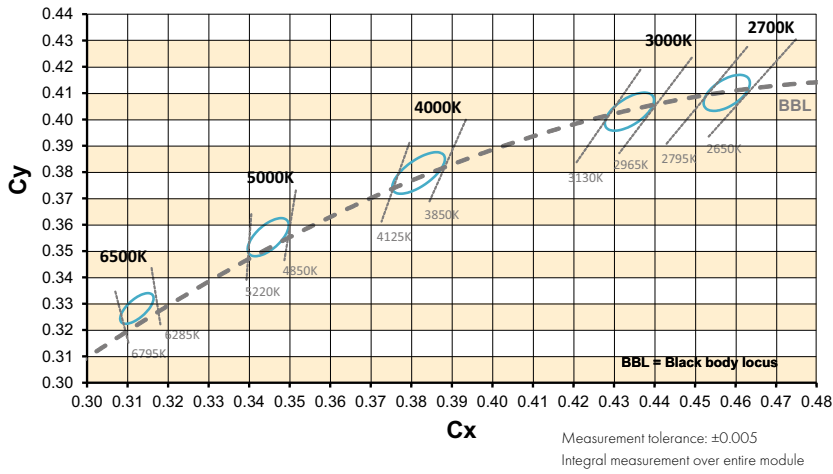

## Fixing Clip

For fastening LED PCBs to luminaire sheets without needing screws  
PCB hole dia.: 4.3–4.5 mm  
Vibration resistant version  
Material: PC, white (UL-94 V2)  
Weight: 0.2 g, Packaging unit: 1000 pcs. (.11 = 10,000 pcs.)

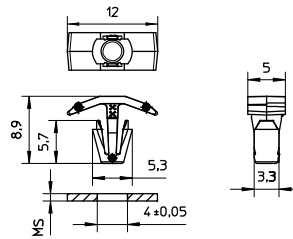

Type	Ref. No.	For luminaire sheet thickness (MS) mm
98050	<b>562870</b>	0.5–1.0*

\* PCB thickness: 1.6 mm

## Linear LED Constant Current Drivers

Please visit our homepage for details for suitable LED constant current drivers: [www.vossloh-schwabe.com](http://www.vossloh-schwabe.com)

The values contained in this data sheet can change due to technical innovations. Any such changes will be made without separate notification.

## Assembly and Safety Information

Installation must be carried out under observation of the relevant regulations and standards. The LED modules are designed for operation within a casing or luminaire. Installation must be carried out in a voltage-free state (i.e. disconnection from the mains). The following advice must be observed; non-observance can result in the destruction of the LED assembly modules, fire and/or other hazards.

- Consider safety regulations acc. EN 60598 in the luminaire design, especially when the operating LED driver is not galvanic isolated.
  - In mode of operation regard to sufficient isolation.
  - Live parts must not be touched in operation mode.  
Danger of death!!!
- ESD (electrostatic discharge) protection measures must be observed when handling and installing the LED modules. See VS's application notes on ESD protection.
- Adequate anti-static electricity measures, including the use of conductive shoes, ionizers, work bench grounding, wrist straps, flooring and stools should be used.
- LED assembly modules must not be subjected to any undue mechanical stress, e. g.:
  - do not treat as bulk cargo
  - avoid shear and compressive forces during handling and installation
  - do not damage circuit paths
  - avoid any pressure on the light emitting surface
- Safe operation only possible by the use of external constant current sources ( $I_{max}$ , see table "Electrical Characteristics").
- Operation only with power supply units that feature the following protection:
  - Short-circuit protection
  - Overload protection
  - Overheating protection
- The module can be fixed with M4 screws. Fixation only with flat or cylinder head screws (M4) (no countersunk screws)  
Max. torque: 1.2 Nm (M4)
- Please ensure the correct polarity of the leads prior to commissioning. Reversed polarity can destroy the modules.
- For interconnection the LED modules is equipped with push-in terminals. (WAGO 2060)
- Safety regulations acc. to EN 60598 (or further standards) has to be observed if the maximum output voltage exceed the permitted touchable value.
- Measurement tolerances:
  - luminous flux:  $\pm 7\%$
  - voltage:  $\pm 3\%$
  - CRI:  $\pm 1$
- The following points must be observed when connecting LED modules in parallel:
  - All LED strings that are wired in parallel must contain the same number of LEDs (symmetrical loading).
  - Owing to differing forward biases, there can be a difference of up to 10% in brightness between modules connected in parallel.



- To ensure problem-free operation, the specified maximum temperature at the  $t_p$  point (see "Operating Life") must be observed (and measured in accordance with EN 60598-1). To satisfy this point, it may be necessary to put measures in place to ensure any heat is dissipated from the PCB to the environment.
- In the event of outdoor applications or applications in damp locations, care must be taken to protect LED assembly modules against humidity, splashes and jets of water. Any corrosion damage resulting from humidity or contact with condensation will not be recognised as a defect or manufacturing fault. LED assembly modules are not specially protected against foreign bodies or dust. Depending on the type of application, further protection must be ensured to prevent dust and foreign bodies from entering.
- Due to the manufacturing process, the PCBs of the LED assembly modules can have sharp edges and corners. Care must therefore be taken during handling and installation to avoid injury.
- For optimal load of used constant current driver the modules can only be connected in series. The quantity of LED modules is limited by the sum of forward voltage and the capacity of used constant current driver. Safety regulations acc. to EN 60598 has to be observed if the sum of forward voltage exceed the permitted touchable value.
- Operating LED modules in the presence of certain chemical substances or in chemically enriched (aggressive) environments can impair module functionality or even cause total module failure. Detailed information can be found in our "Chemical Incompatibility" PDF on our website [www.vossloh-schwabe.com](http://www.vossloh-schwabe.com)
- The photobiological safety of the LED modules must be classified into risk groups in accordance with EN 62471: 2008.  
Rating in accordance with IEC / TR 62778: risk group 1

CCT K	Max. operating current for risk group 1 mA	E threshold for higher operating currents to be risk group 1 lx
$\leq 4000$	951	1221
5000	783	1009
6500	615	793

### Applied Standards

EN 62031

LED modules for general lighting – Safety specifications



EN 62471

Photobiological safety of lamps and lamp systems

### Product Guarantee

- 5 years
- The conditions for the Product Guarantee of the Vossloh-Schwabe Group shall apply as published on our homepage ([www.vossloh-schwabe.com](http://www.vossloh-schwabe.com)). We will be happy to send you these conditions upon request.

The values contained in this data sheet can change due to technical innovations. Any such changes will be made without separate notification.